

Chapter 5: Data Link Control

Raj Jain

**Raj Jain is now at
Washington University in Saint Louis
Jain@cse.wustl.edu
<http://www.cse.wustl.edu/~jain/>**



- ❑ Data link functions
- ❑ Flow Control
- ❑ Effect of propagation delay, speed, frame size
- ❑ Error Control
- ❑ Example: HDLC

Data Link Functions

- ❑ Frame Synchronization
- ❑ Handle point-to-point and multipoint lines
- ❑ Flow control
- ❑ Error control
- ❑ Addressing
- ❑ Multiplex data and control on the same link
- ❑ Link management

Line Duplexity

- ❑ Simplex: Transmit or receive

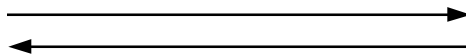

- ❑ Full Duplex: Transmit and receive simultaneously
- ❑ Half-Duplex: Transmit and receive alternately

Line Topology

Point-to-Point

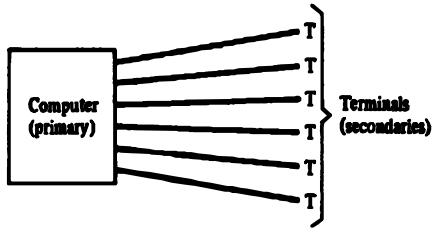

Point to Multipoint



Fig 5.1
5-5

Line Discipline: Point-to-Point

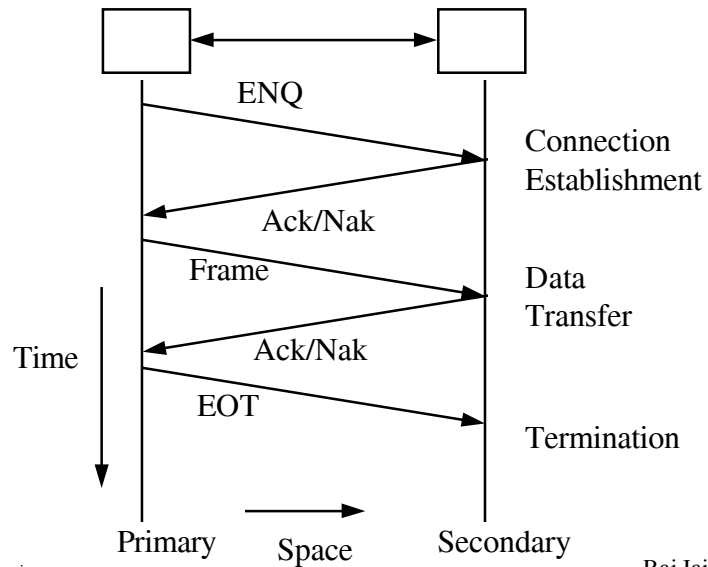

5-6

Line Discipline: Multipoint Links

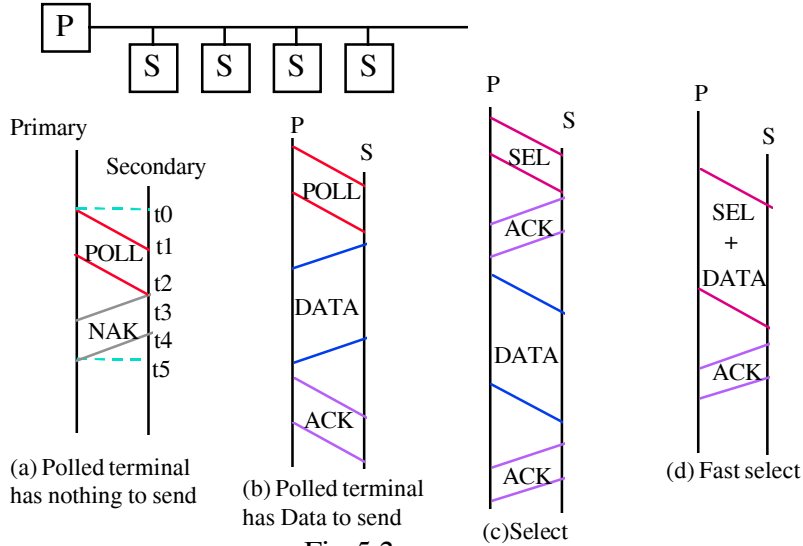

The Ohio State University

Fig 5.3

Raj Jain

5-7

Flow Control

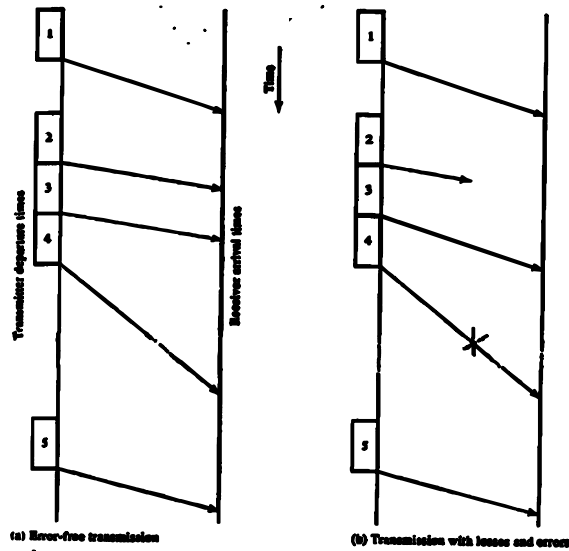

The Ohio State University

Fig 5.4

Raj Jain

5-8

Stop and Wait Flow Control

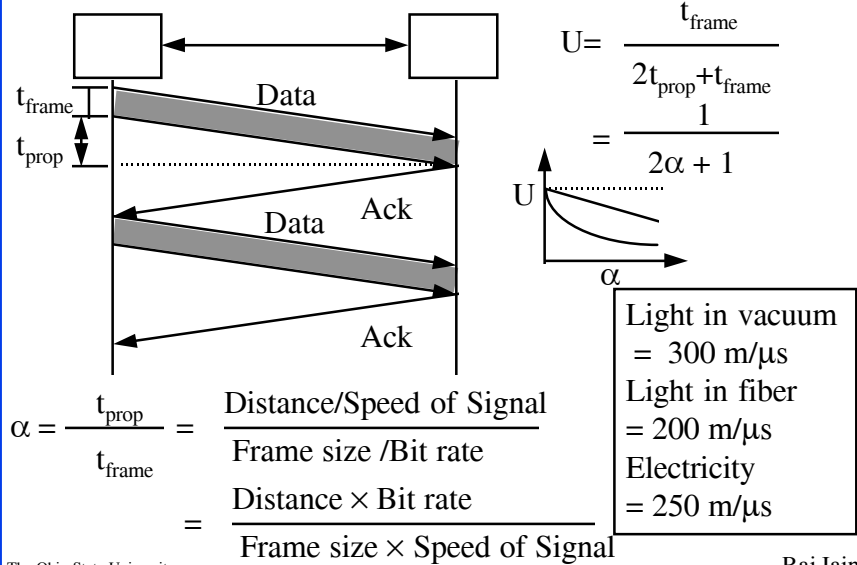

The Ohio State University

5-9

Raj Jain

Utilization: Examples

- Satellite Link: Propagation Delay $t_{\text{prop}} = 270$ ms
 Frame Size = 4000 bits = 500 bytes
 Data rate = 56 kbps $\Rightarrow t_{\text{frame}} = 4/56 = 71$ ms
 $\alpha = t_{\text{prop}}/t_{\text{frame}} = 270/71 = 3.8$
 $U = 1/(2\alpha+1) = 0.12$
- Short Link: 1 km = 5 μ s,
 Rate=10 Mbps,
 Frame=500 bytes $\Rightarrow t_{\text{frame}} = 4k/10M = 400$ μ s
 $\alpha = t_{\text{prop}}/t_{\text{frame}} = 5/400 = 0.012 \Rightarrow U = 1/(2\alpha+1) = 0.98$

The Ohio State University

5-10

Raj Jain

Sliding Window Protocol

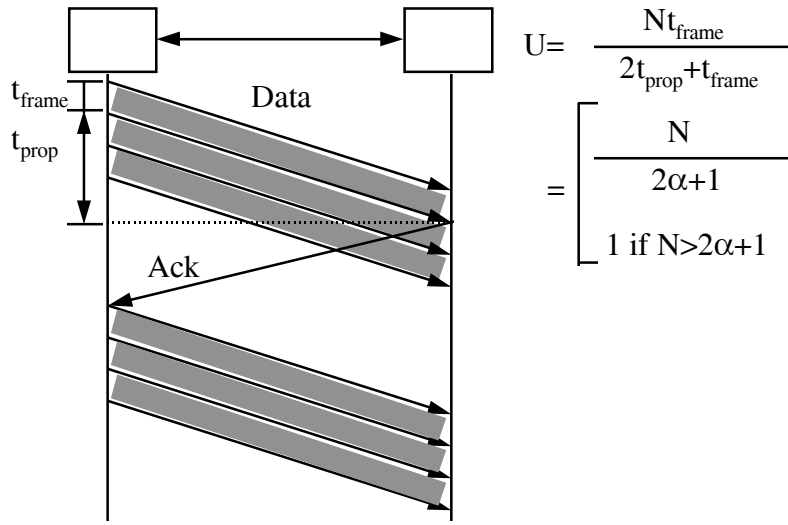

$$U = \frac{N t_{frame}}{2 t_{prop} + t_{frame}}$$

$$= \begin{cases} \frac{N}{2\alpha + 1} \\ 1 \text{ if } N > 2\alpha + 1 \end{cases}$$

Sliding Window

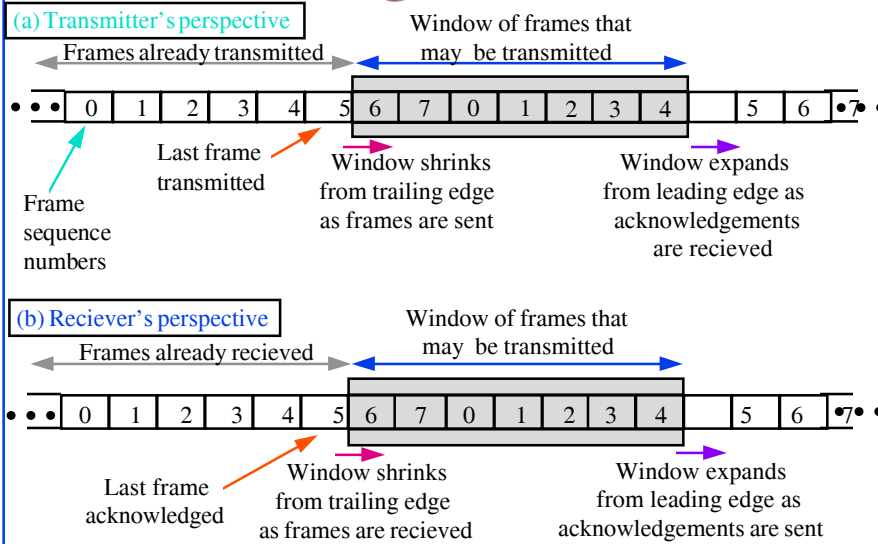

Fig 5.6

Sliding Window: Example

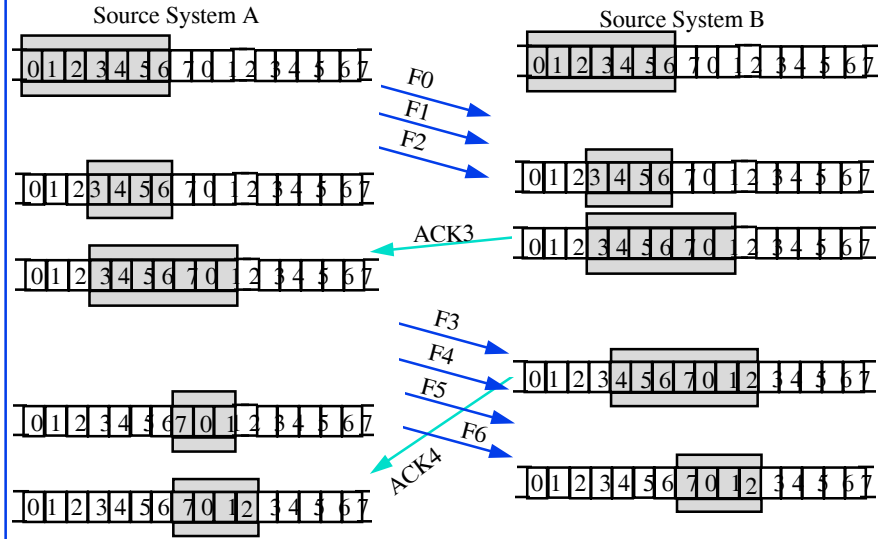

Fig 5.7
5-13

Effect of Window Size

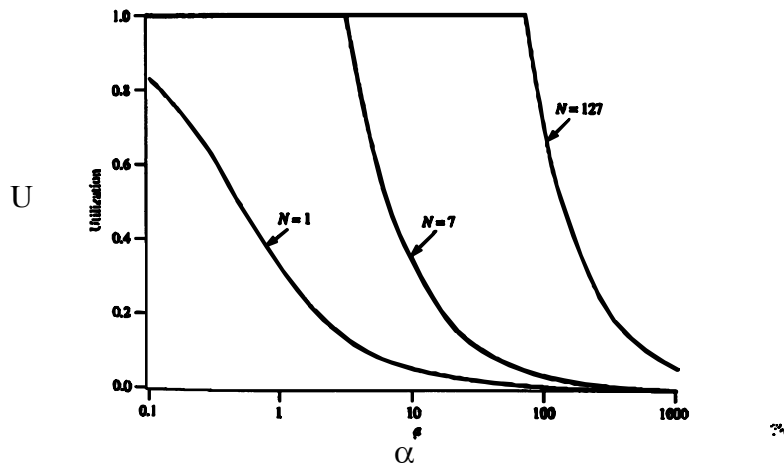
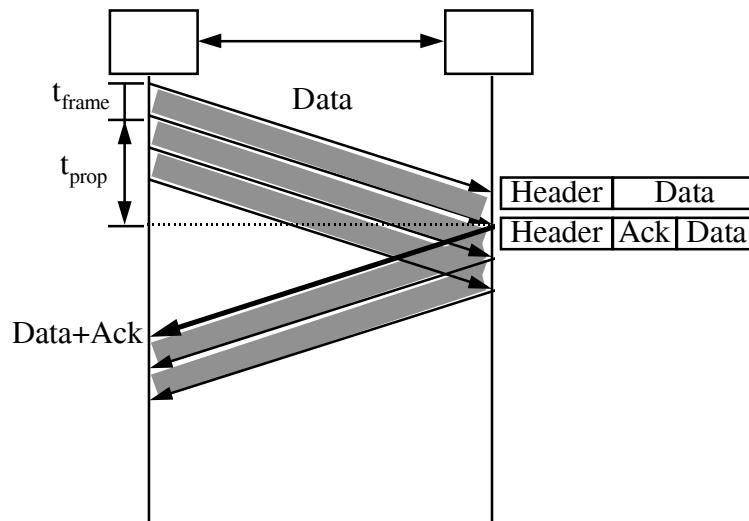

Fig 5.9
5-14

Piggybacking



Error Control

- Automatic Repeat Request (ARQ)
 - Error detection
 - Acknowledgment
 - Retransmission after timeout
 - Negative Acknowledgment

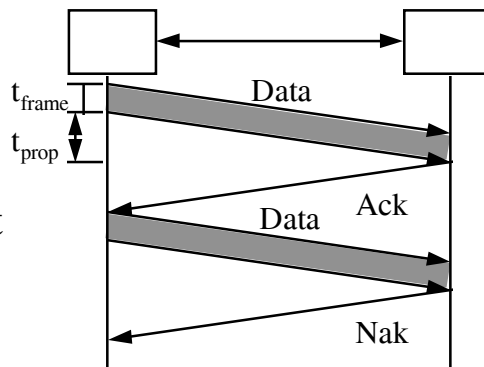

Stop-and-Wait ARQ

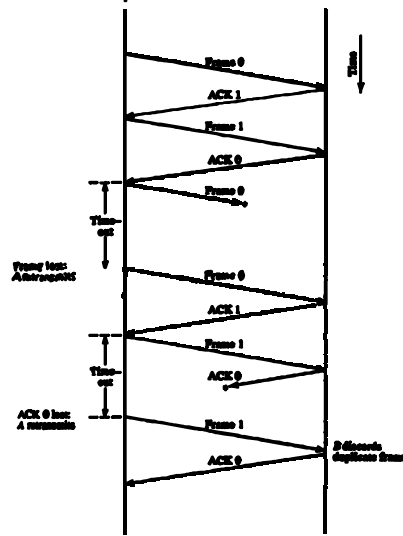
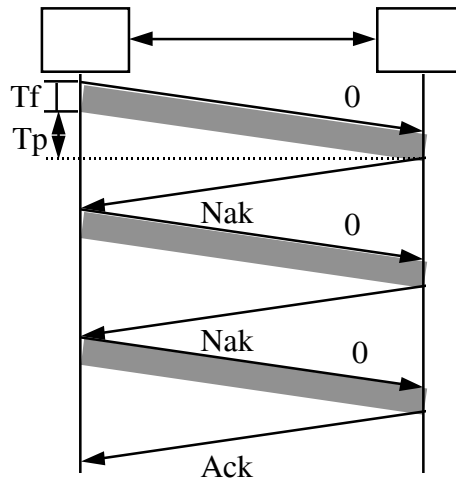

Fig 5.10

Performance: Stop-and-Wait

- $P = \text{Probability of Frame Error}$
- $\alpha = T_p / T_f$
- $U = T_f / [N_r(T_f + 2T_p)] = 1 / [N_r(1 + 2\alpha)]$
- $N_r = \sum_i i P^{i-1} (1-P) = 1 / (1-P)$
- $U = (1-P) / (1 + 2\alpha)$



Performance: Go-back-N

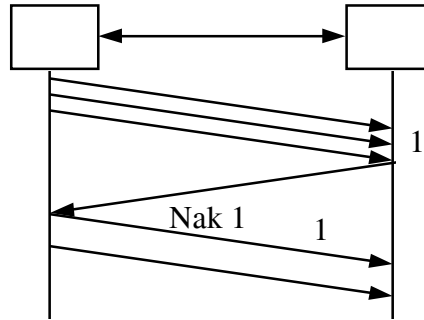

- Frames Retransmitted = $2\alpha + 1$ if $N > 2\alpha + 1$
 N otherwise
- $U = (1-P)/(1+2\alpha P)$ if $N > 2\alpha + 1$
 $N(1-P)/[(2\alpha + 1)(1-P + NP)]$ otherwise

Selective-Reject ARQ

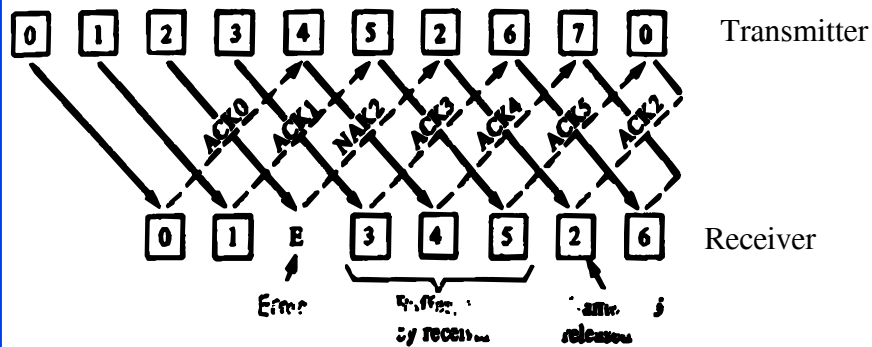

Selective Reject: Window Size

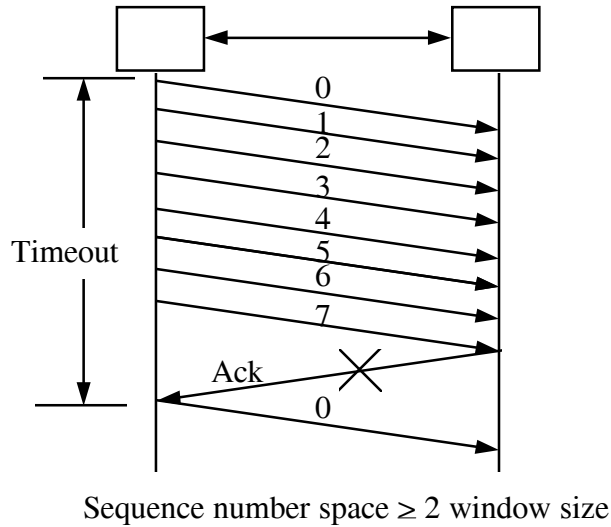

Performance: Selective Reject

- Error Free:
 $U=1$ if $N > 2\alpha + 1$
 $N/(2\alpha + 1)$ otherwise

- With Errors:
 $N_r = \sum_i i P^{i-1} (1-P)$
 $= 1/(1-P)$

- $U = (1-P)$ if $N > (1 + 2\alpha)$
 $N(1-P)/(1 + 2\alpha)$ otherwise

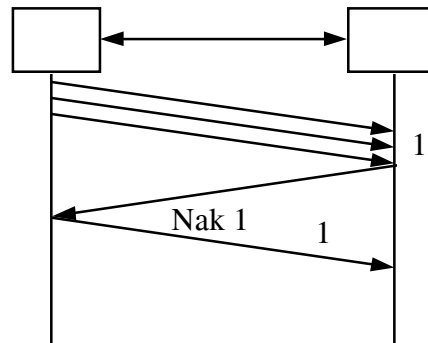

Performance Comparison

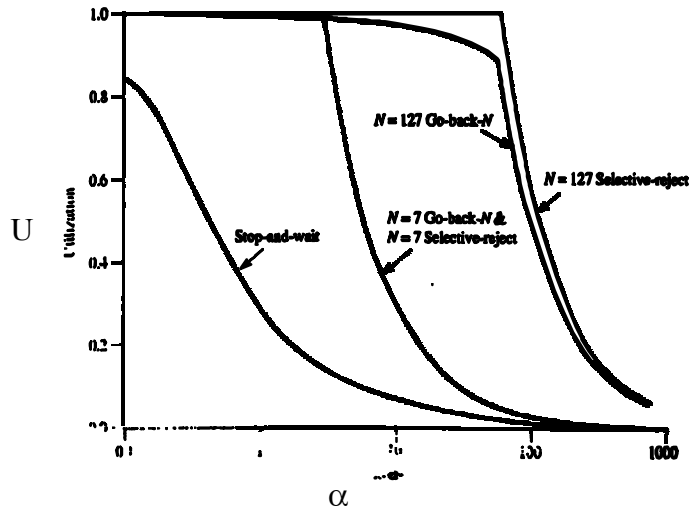

The Ohio State University

Fig 5.12
5-25

Raj Jain

HDLC Family

- ❑ Synchronous Data Link Control (SDLC): IBM
- ❑ High-Level Data Link Control (HDLC): ISO
- ❑ Link Access Procedure-Balanced (LAPB): X.25
- ❑ Link Access Procedure for the D channel (LAPD): ISDN
- ❑ Link Access Procedure for modems (LAPM): V.42
- ❑ Link Access Procedure for half-duplex links (LAPX): Teletex
- ❑ Point-to-Point Protocol (PPP): Internet
- ❑ Logical Link Control (LLC): IEEE
- ❑ Advanced Data Communications Control Procedures (ADCCP): ANSI
- ❑ V.120 and Frame relay also use HDLC

The Ohio State University

Raj Jain

HDLC

- Primary station: Issue commands
- Secondary Station: Issue responses
- Combined Station: Both primary and secondary
- Unbalanced Configuration: One or more secondary
- Balanced Configuration: Two combined station
- Normal Response Mode (NRM): Response from secondary
- Asynchronous Balanced Mode (ABM): Combined Station
- Asynchronous Response Mode (ARM): Secondary may respond before command

The Ohio State UniversityRaj Jain

HDLC Frame Structure

Frame Format

FLAG	ADDRESS	INFORMATION	FCS	FLAG
← 8 →	← 8 →	← 8 or 16 →	← 16 or 32 →	← 8 →
bits	Extendable	Extendable		

Control Field Format

	1	2	3	4	5	6	7	8
I: Information	0	N(S)			P/F	N(R)		
S: Supervisory	1	0	S		P/F	N(R)		
U: Unnumbered	1	1	M		P/F	M		

N(S)= Send sequence number N(R)= Recieve sequence number
 S= Supervisory function bits M= Unnumbered bits P/F= Poll/final bit

Extended Address Field

1	2	3	4	5	6	7	8	9	10	11	12	13	14	15	16		8n																											
0															0															1														

Extended Control Field

	1	2	3	4	5	6	7	8	9	10	11	12	13	14	15	16
Information	0	N(S)						P/F	N(R)							
Supervisory	1	0	S	0	0	0	0	P/F	N(R)							

Fig 5.13

The Ohio State UniversityRaj Jain

Bit Stuffing

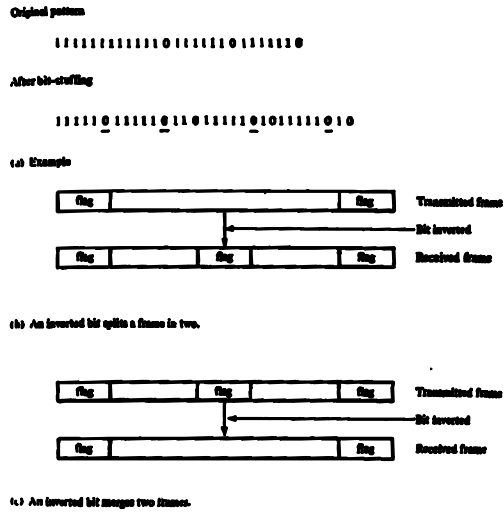

HDLC Frames

- Information Frames: User data
 - Piggybacked Acks: Next frame expected
 - Poll/Final = Command/Response
- Supervisory Frames: Flow and error control
 - Go back N and Selective Reject
 - Final \Rightarrow No more data to send
- Unnumbered Frames: Control
 - Mode setting commands and responses
 - Information transfer commands and responses
 - Recovery commands and responses
 - Miscellaneous commands and responses

HDLC Commands and Responses

Name	Function	Description
Information (I)	C/R	Exchange user data
Supervisory (S)		
Receive Ready (RR)	C/R	Positive Acknowledgement; ready to receive I-frame
Receive Not Ready (RNR)	C/R	Positive acknowledgement; not ready to receive
Reject (REJ)	C/R	Negative acknowledgement; go back N
Selective Reject (SREJ)	C/R	Negative acknowledgement; selective reject
Unnumbered (U)		
Set Normal Response / Extended Mode (SNRM / SNRME)	C	Set mode; extended=two-octet control field
Set Asynchronous Response / Extended Mode (SARM / SARME)	C	Set mode; extended=two-octet control field
Set Asynchronous Balanced / Extended Mode (SABM / SABME)	C	Set mode; extended=two-octet control field
Set Initialization Mode (SIM)	C	Initialize link control functions in addressed station

The Ohio State University

Table 5.1

Raj Jain

5-31

HDLC Commands and Responses (cont)

Name	Function	Description
Disconnect (DISC)	C	Terminate logical link connection
Unnumbered Acknowledgement (UA)	R	Acknowledges acceptance of one of the above set-mode commands
Disconnect Mode (DM)	R	Secondary is logically disconnected
Request Disconnect (RD)	R	Request for DISC command
Request Initialization Mode (RIM)	R	Initialization needed; request for SIM command
Unnumbered Information (UI)	C/R	Used to exchange control information
Unnumbered Poll (UP)	C	Used to solicit control information
Reset (RSET)	C	Used for recovery; resets N(R), N(S)
Exchange Identification (XID)	C/R	Used to request/report identity and status
Test (TEST)	C/R	Exchange identical information fields for testing
Frame Reject (FRMR)	R	Reports receipt of unacceptable frame

The Ohio State University

Raj Jain

5-32

Examples of HDLC Operation

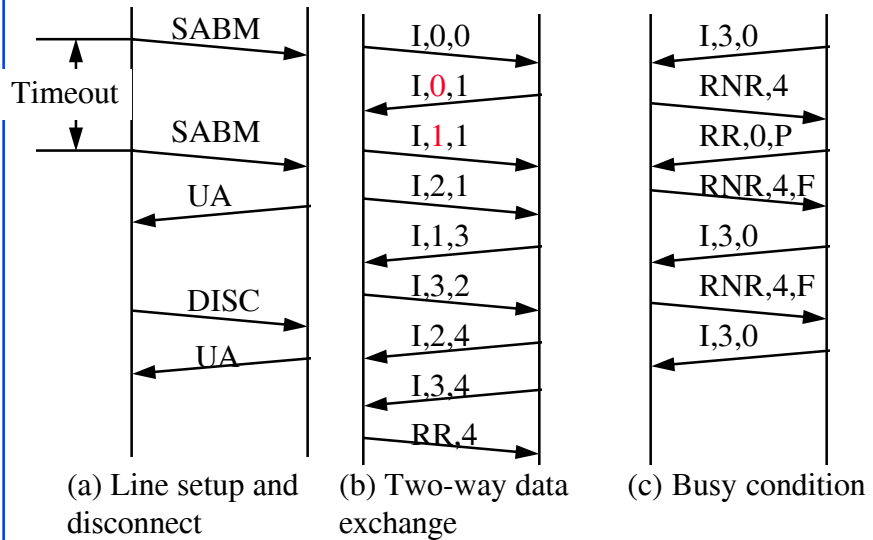

Examples of Operation (Cont)

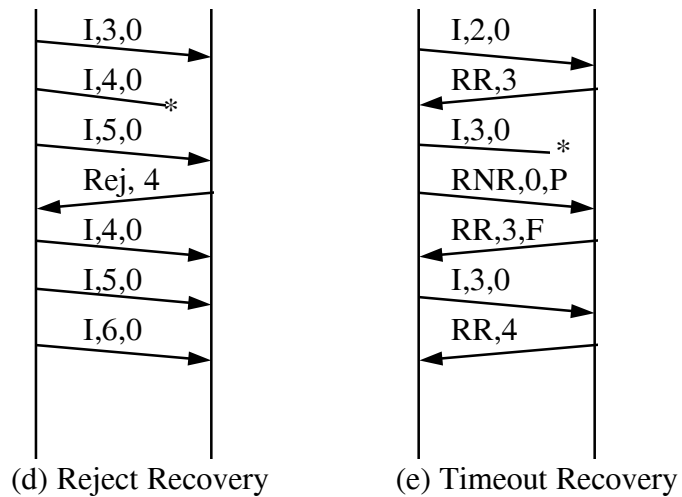

Summary

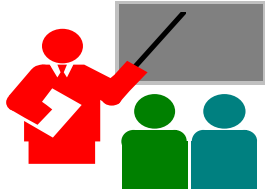

- Line: point-to-point, multipoint, simplex, full-duplex, half-duplex
- Flow Control: Stop and Wait, Sliding window
- Effect of propagation delay, speed, frame size
- Error Control: Stop and wait ARQ, Go-back-N, Selective Reject
- HDLC: Bit stuffing, Flag, I-Frame, RR, RNR

Homework: Chapter 5

- Exercises: **5.7, 5.14, 5.18, 5.20**
- Due: Next class