

ATM Networks: An Overview

Raj Jain

Pr

h

**Raj Jain is now at
Washington University in Saint Louis
Jain@cse.wustl.edu
<http://www.cse.wustl.edu/~jain/>**

ices

'-98/



- ❑ ATM vs Phone Networks and Data Networks
- ❑ ATM Protocol Layers
- ❑ Cell Header Format, AALs
- ❑ Physical Media

ATM

- ❑ Asynchronous Transfer Mode
- ❑ ATM Net = Data Net + Phone Net
- ❑ Combination of Internet method of communication (packet switching) and phone companies' method (circuit switching)

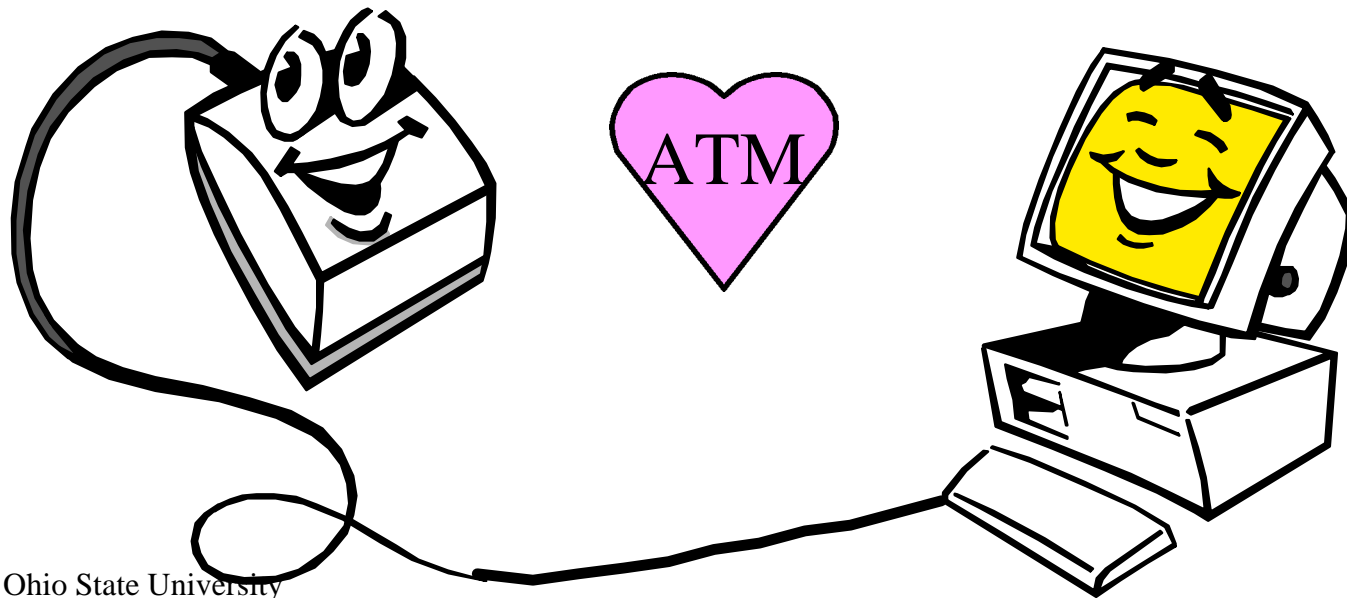

ATM vs Phone Networks

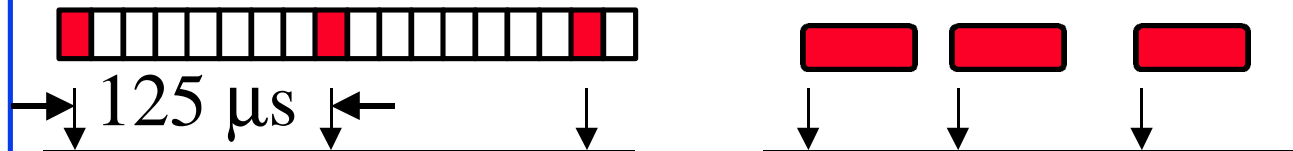

- ❑ Current phone networks are synchronous (periodic).
ATM = Asynchronous Transfer Mode
- ❑ Phone networks use circuit switching.
ATM networks use “Packet” Switching
- ❑ In phone networks, all rates are multiple of 8 kbps.
With ATM service, you can get any rate.
You can vary your rate with time.
- ❑ With current phone networks, all high speed circuits are manually setup. ATM allows dialing any speed.

ATM vs Data Networks

- ❑ Signaling: Internet Protocol (IP) is connectionless. You cannot reserve bandwidth in advance. ATM is connection-oriented. You declare your needs before using the network.
- ❑ PNNI: Path based on quality of service (QoS)
- ❑ Switching: In IP, each packet is addressed and processed individually.
- ❑ Traffic Management: Loss based in IP. ATM has 1996 traffic management technology. Required for high-speed and variable demands.
- ❑ Cells: Fixed size or small size is not important

Old House vs New House

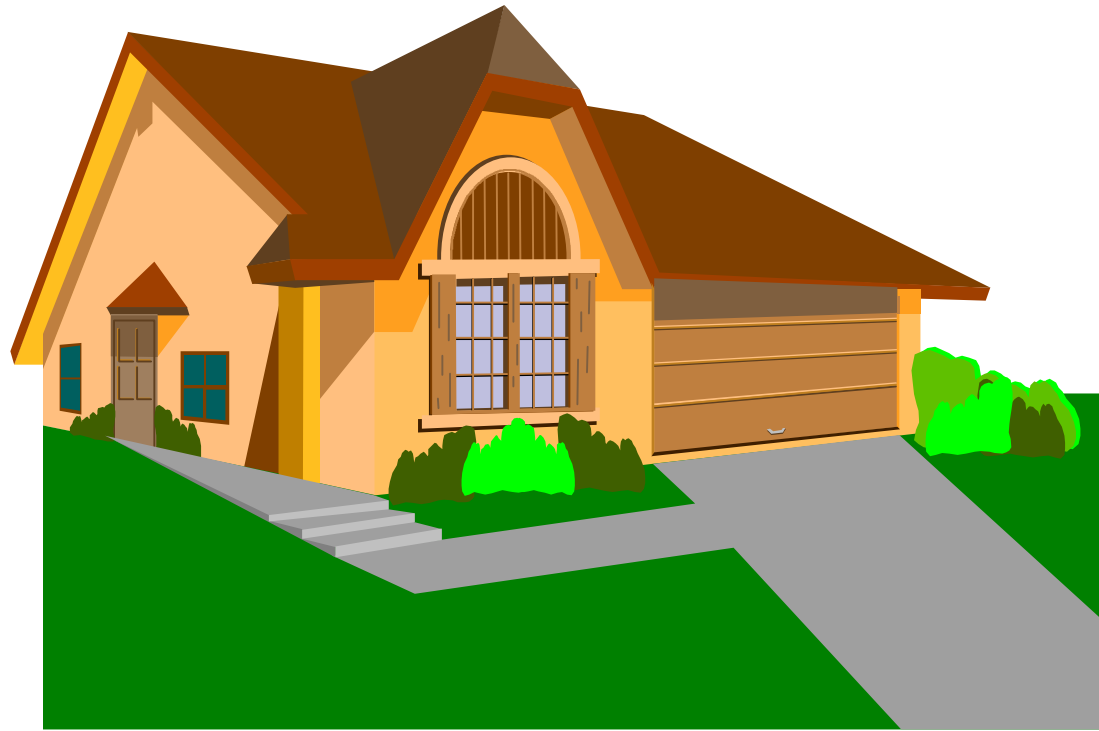
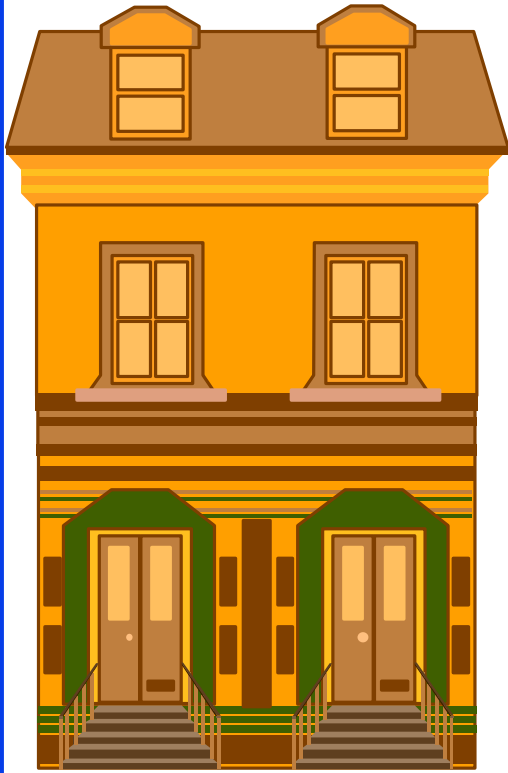

New needs:

Solution 1: Fix the old house (cheaper initially)

Solution 2: Buy a new house (pays off over a long run)

ATM Interfaces

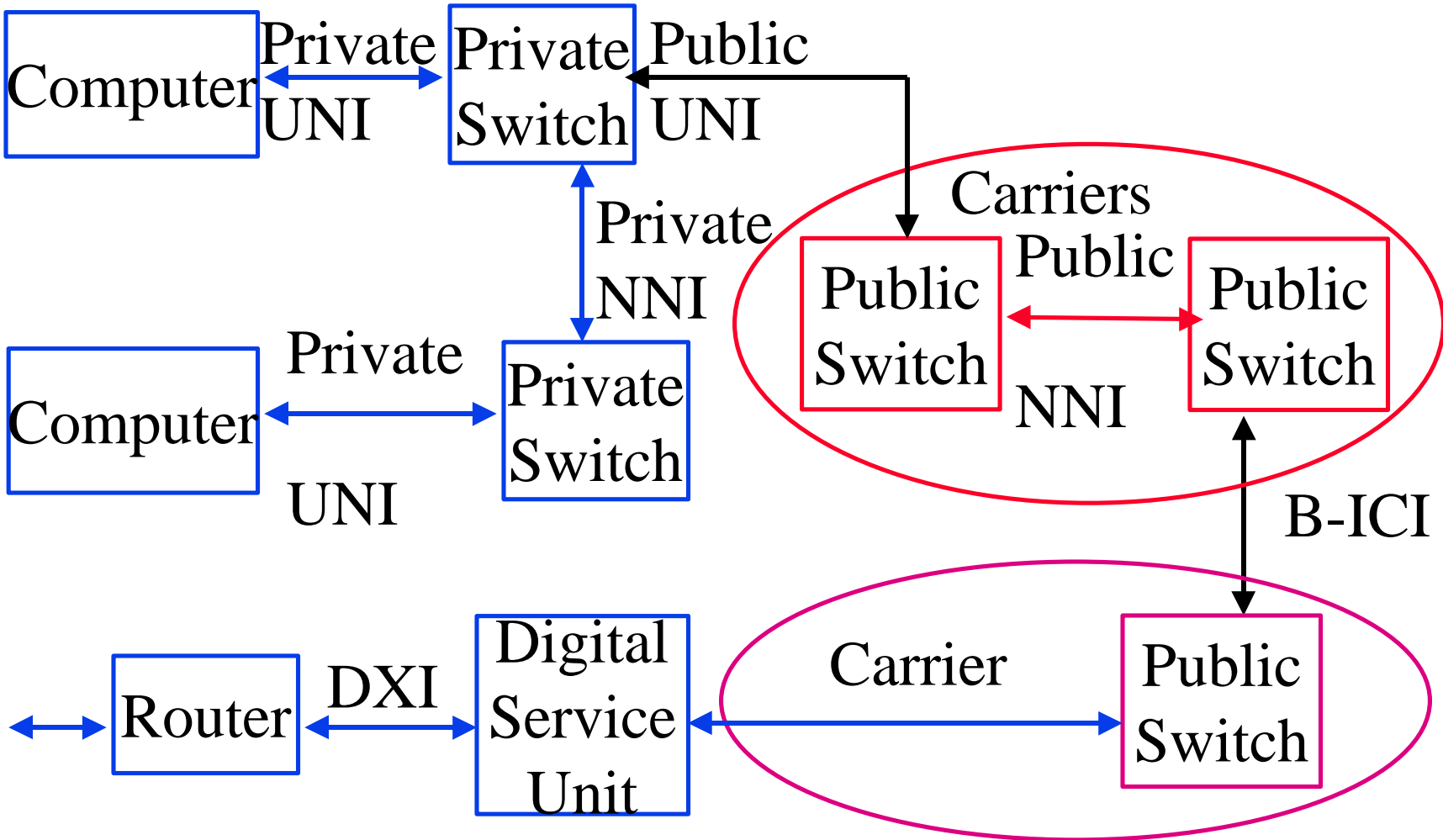

ATM Interfaces

- ❑ User to Network Interface (UNI):
Public UNI, Private UNI
- ❑ Network to Node Interface (NNI):
 - Private NNI (P-NNI)
 - Public NNI = Inter-Switching System Interface (ISSI)
Intra-LATA ISSI (Regional Bell Operating Co)
 - Inter-LATA ISSI (Inter-exchange Carriers)
⇒ Broadband Inter-Carrier Interface (B-ICI)
- ❑ Data Exchange Interface (DXI)
Between routers and ATM Digital Service Units (DSU)

Protocol Layers

End System

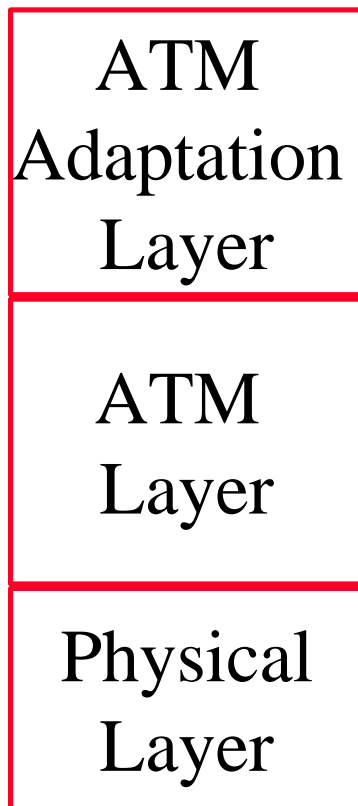

End System

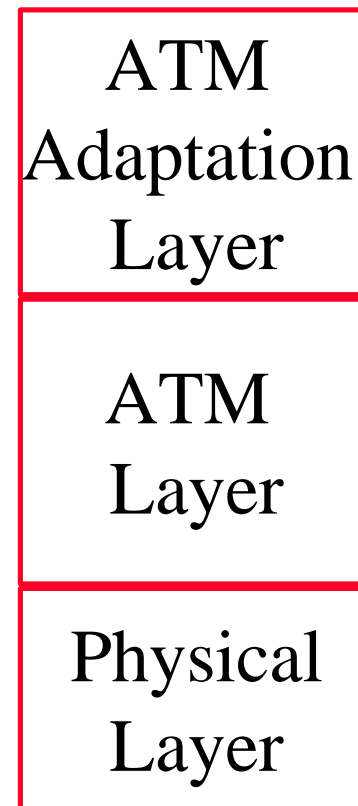

Switch

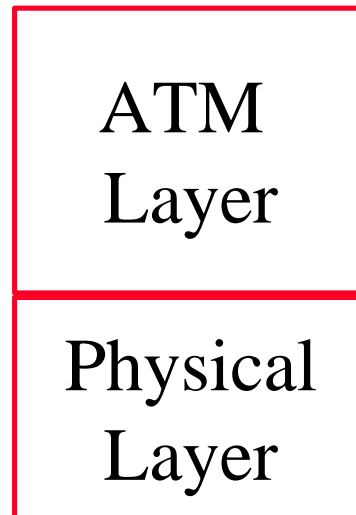

Protocol Layers

- The ATM Adaptation Layer
 - How to break messages to cells
- The ATM Layer
 - Transmission/Switching/Reception
 - Congestion Control/Buffer management
 - Cell header generation/removal at source/destination
 - Cell address translation
 - Sequential delivery

Virtual Circuit Switching

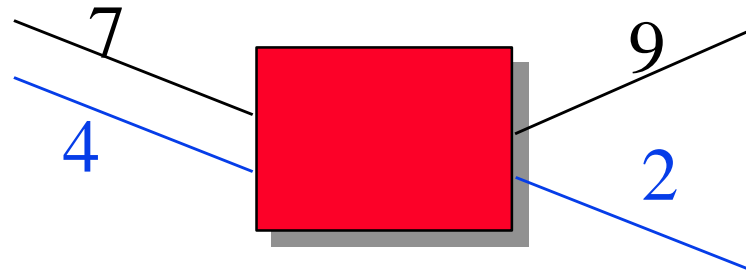

- ❑ Circuit Switching: bits coming on wire 4 go on wire 2
- ❑ Virtual Circuit Switching: Cells coming on VCI=4 go on VCI=2

Cell Header Format

- GFC = Generic Flow Control
 - (Was used in UNI but not in NNI)
- VPI/VCI = 0/0 \Rightarrow Idle cell; 0/n \Rightarrow Signaling

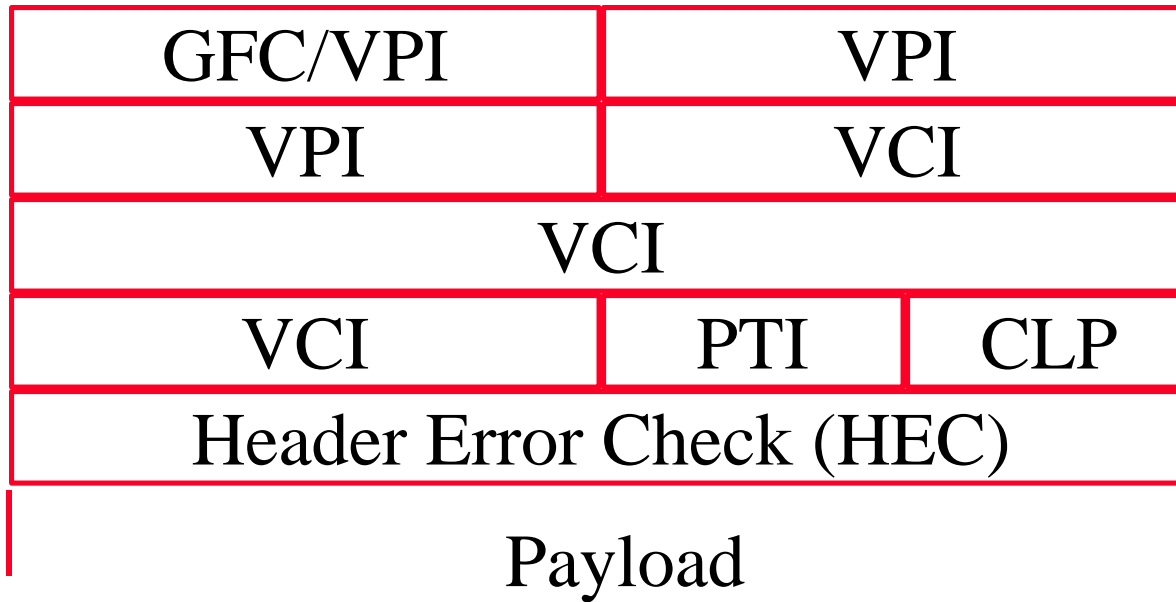

Header Error Check (HEC)

- ❑ $1 + x + x^2 + x^8$
- ❑ Protects header only
- ❑ Optional Correction mode: Correct one bit errors if no earlier errors
- ❑ Discard cells with bad HEC
- ❑ Recalculated on each hop

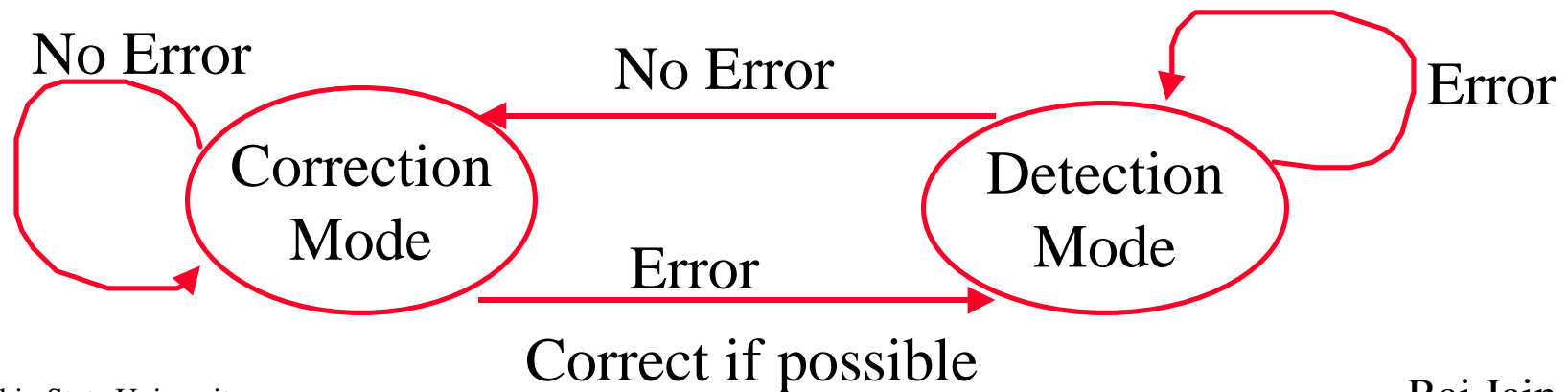

Payload Type Field Coding

- ❑ 000 User data cell, no congestion, AAU = 0
- ❑ 001 User data cell, no congestion, AAU = 1
- ❑ 010 User data cell, congestion, AAU = 0
- ❑ 011 User data cell, congestion, AAU = 1
- ❑ 100 Segment Operation and management (OAM) cell
- ❑ 101 End-to-end OAM cell
- ❑ 110 Resource management cell
- ❑ 111 Reserved

ATM-user-to-ATM-user (AAU) bit available for user-to-user indication

Path vs Channels

- 24/28-bit connection identifier
First 8/12 bits: Virtual Path,
Last 16 bits: Virtual Circuit
- VP service allows new VC's w/o orders to carriers

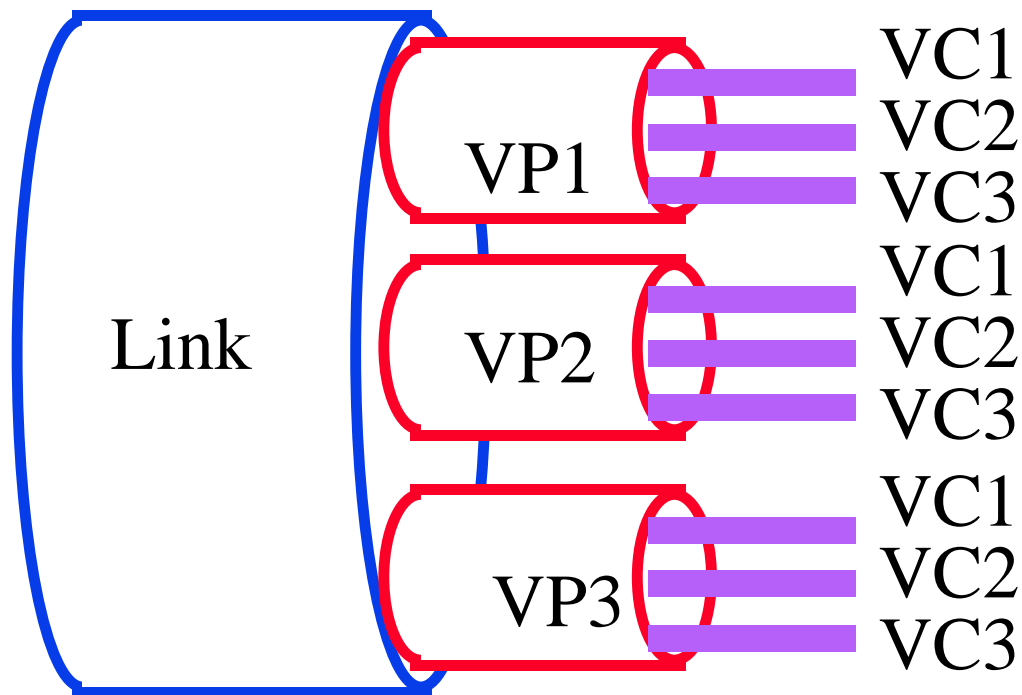

VP/VC Assignment/Use

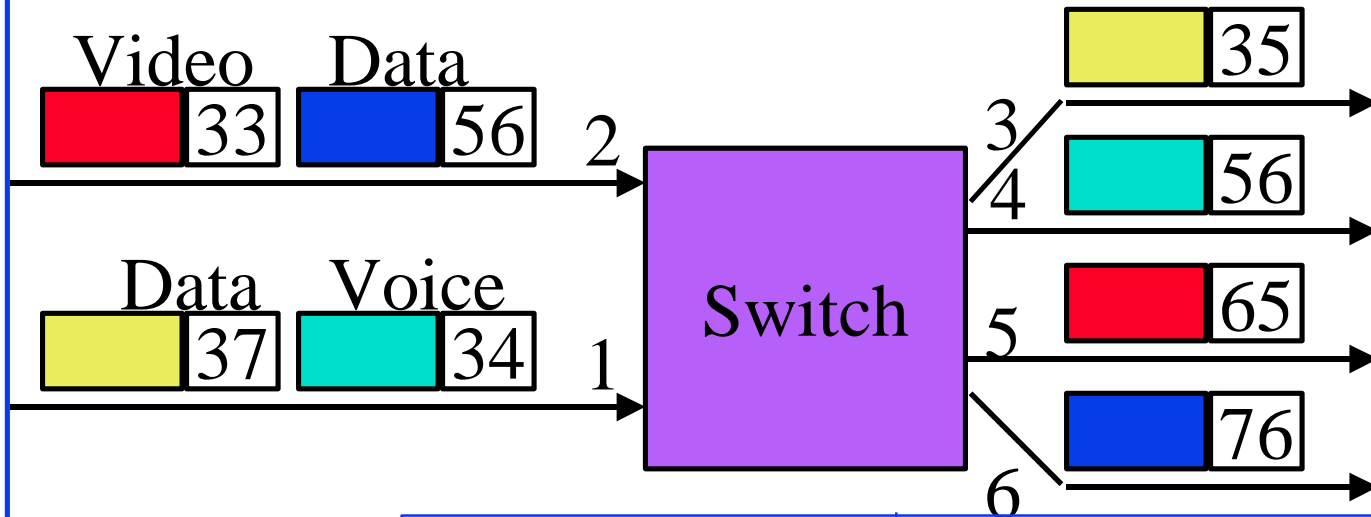

In		Out	
Port	VPI/VCI	Port	VPI/VCI
1	0/37	3	1/35
1	0/34	4	0/56
2	0/33	5	0/65
2	0/56	6	4/76

Original Classes of Traffic

	Class A	Class B	Class C	Class D
Time Sync	Yes	Yes	No	No
Bit Rate	Constant	Variable	Variable	Variable
Connection -Oriented	Yes	Yes	Yes	No
Examples	Circuit Emulation	Comp. Video	Frame Relay	SMDS
AAL	AAL1	AAL2	AAL3	AAL4

AAL 5

- ❑ Designed for data traffic
- ❑ Less overhead bits than AAL 3/4
⇒ Simple and Efficient AAL (SEAL)
- ❑ No per cell length field, No per cell CRC

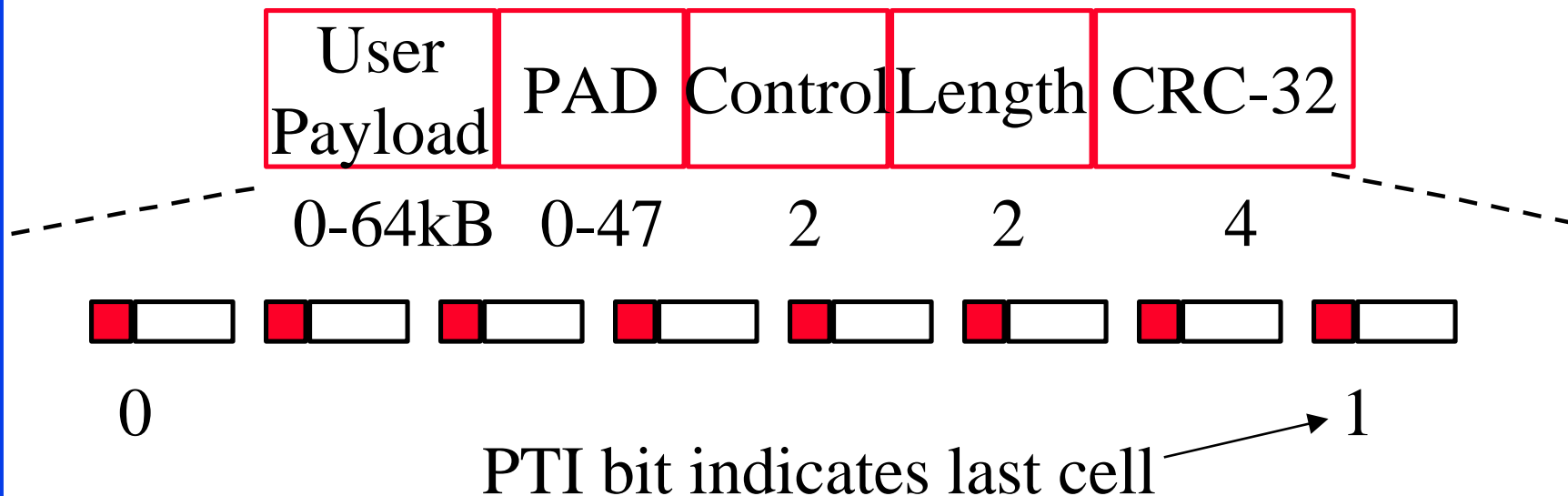

AAL2

- ❑ Ideal for low bit rate voice
- ❑ Variable/constant rate voice
- ❑ Multiple users per VC
- ❑ Compression and Silence suppression
- ❑ Idle channel suppression

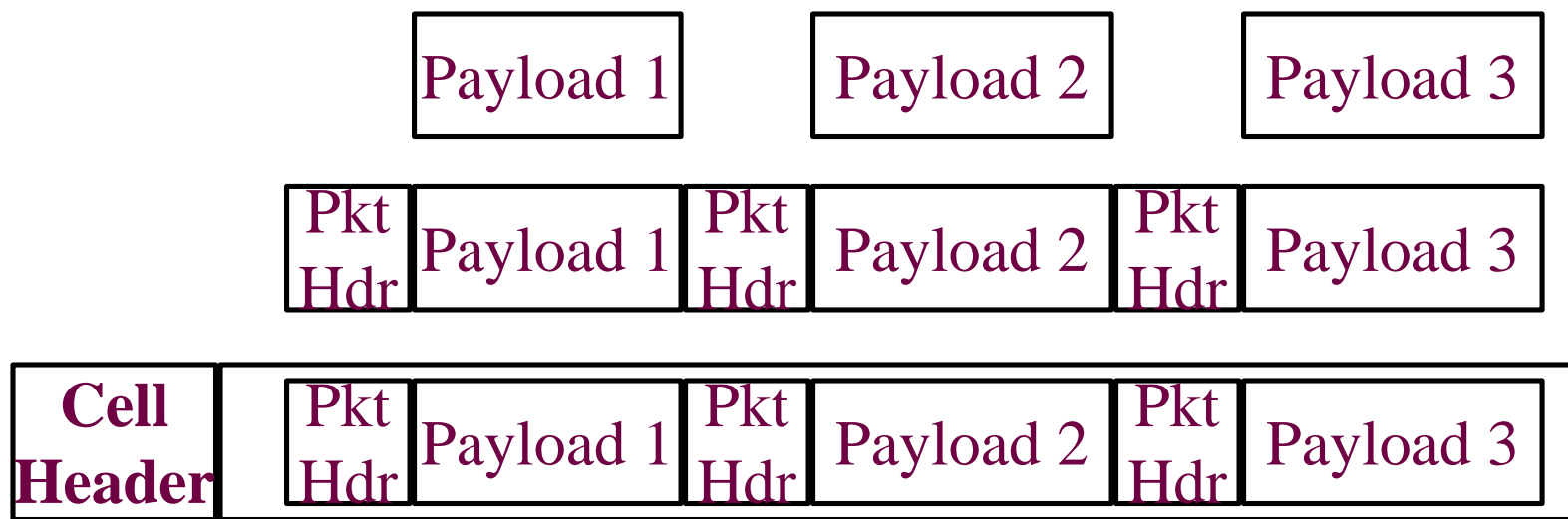

Cell-Stream Phy

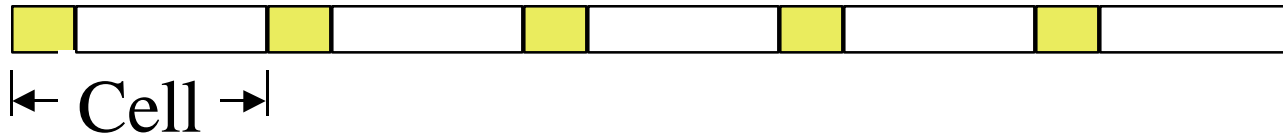

- ❑ Continuous stream of cells. No framing.
- ❑ Hunt bit-by-bit for correct header.
- ❑ Look for δ correct headers before entering synch state
- ❑ α incorrect headers \Rightarrow resynchronize
 α and δ are parameters.

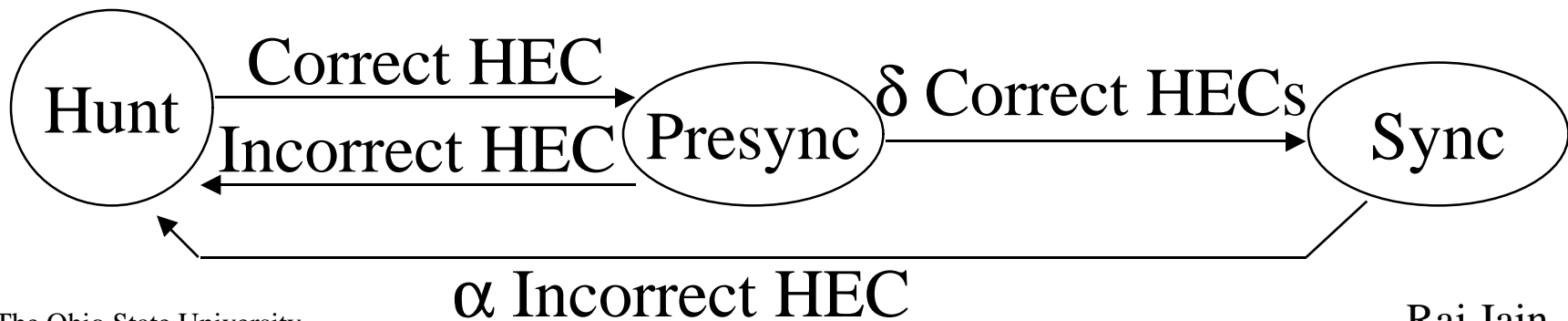

SONET

- ❑ Synchronous optical network
- ❑ Standard for digital optical transmission (bit pipe)
- ❑ Developed originally by Bellcore.
Standardized by ANSI T1X1
Standardized by CCITT
⇒ Synchronous Digital Hierarchy (SDH)
- ❑ You can lease a SONET connection from carriers

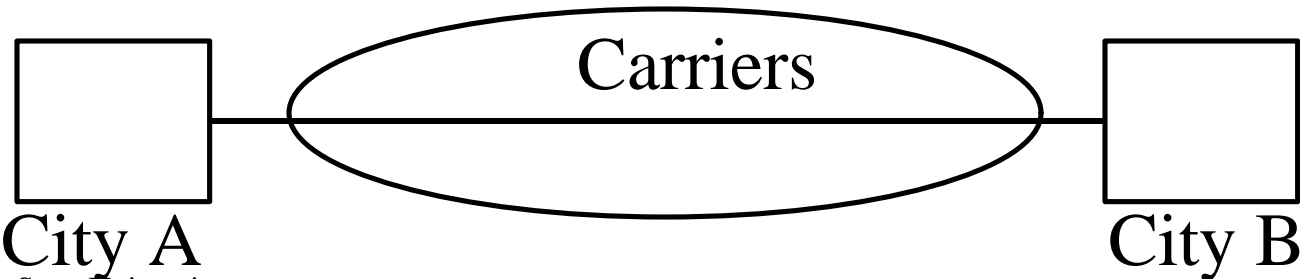

Signal Hierarchy

Synchronous Transport Signal Level $n = \text{STS-}n = n \times 51.84 \text{ Mbps}$
 STM=Synchronous Transport Module, OC=Optical Carrier level

ANSI Designation	Optical Signal	CCITT Designation	Data Rate (Mbps)	Payload Rate (Mbps)
STS-1	OC-1		51.84	50.112
STS-3	OC-3	STM-1	155.52	150.336
STS-9	OC-9	STM-3	466.56	451.008
STS-12	OC-12	STM-4	622.08	601.344
STS-18	OC-18	STM-6	933.12	902.016
STS-24	OC-24	STM-8	1244.16	1202.688
STS-36	OC-36	STM-12	1866.24	1804.032
STS-48	OC-48	STM-16	2488.32	2405.376
STS-96	OC-96	STM-32	4976.64	4810.176
STS-192	OC-192	STM-64	9953.28	9620.928

STS-3c Frame Format

- ❑ STS-3c is similar to STM-1
- ❑ $125 \mu\text{s} = 2430$ bytes at 155.54 Mbps

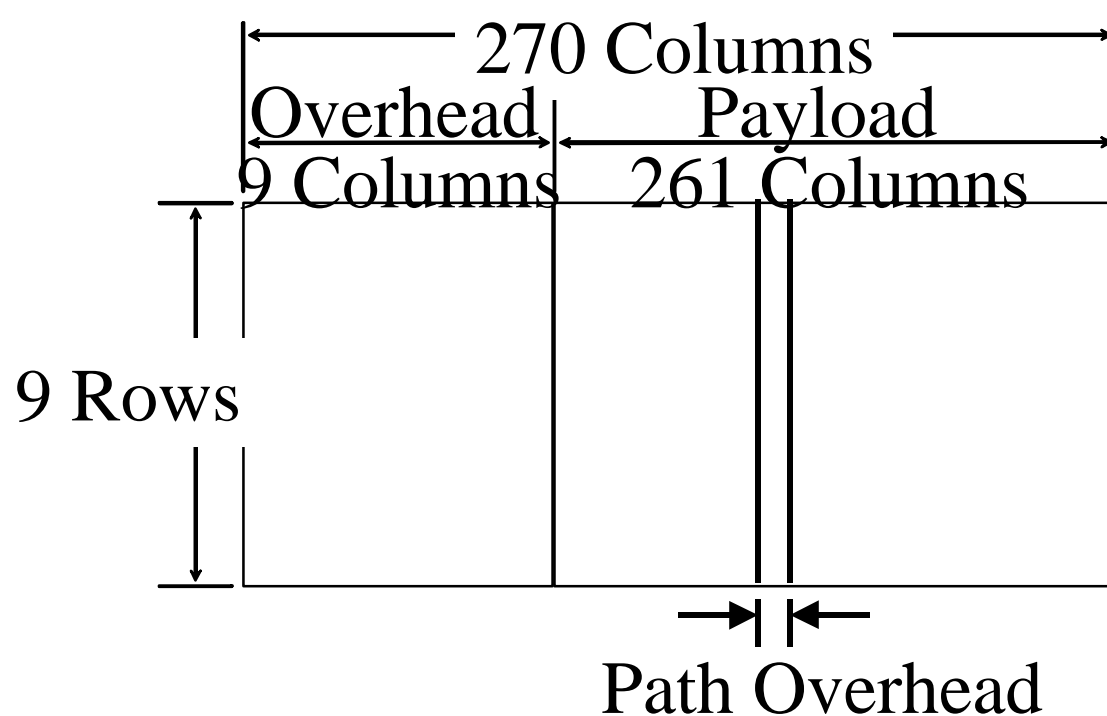

- ❑ Note: All sizes are multiples of 3

SONET/SDH Phy

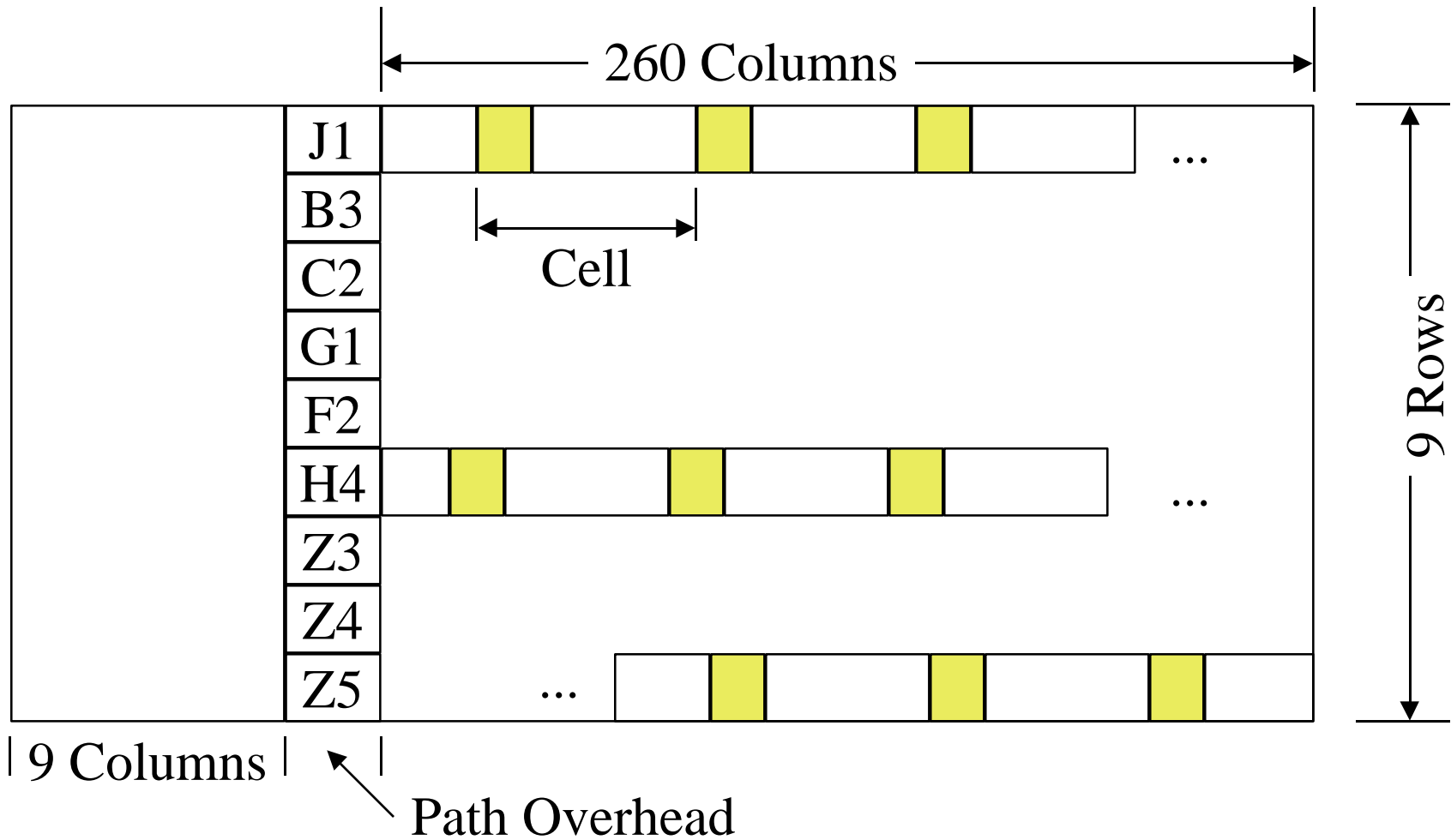

SONET STS-3c

- ❑ Payload rate = $9 \times 260 \times 8/125 = 149.76$ Mbps
- ❑ Cell payload rate = 135.63 Mbps
- ❑ Cell delineation using HEC.
 - Look for 5-byte blocks with HEC separated by 48 bytes
- ❑ Cells are packed one after another \Rightarrow One can send 127 bits matching the scrambling sequence resulting in all 1's or 0's.
Scramble by dividing by $1 + x^{43}$.
Only one in 2^{43} patterns will cause all 1's or 0's.

Physical Media

- ❑ Multimode Fiber: 100 Mbps using 4b/5b, 155 Mbps SONET STS-3c, 155 Mbps 8b/10b
- ❑ Single-mode Fiber: 155 Mbps STS-3c, 622 Mbps
- ❑ Plastic Optical Fiber: 155 Mbps
- ❑ Shielded Twisted Pair (STP): 155 Mbps 8b/10b
- ❑ Coax: 45 Mbps, DS3, 155 Mbps
- ❑ Unshielded Twisted Pair (UTP)
 - UTP-3 (phone wire) at 25.6, 51.84, 155 Mbps
 - UTP-5 (Data grade UTP) at 155 Mbps
- ❑ DS1, DS3, STS-3c, STM-1, E1, E3, J2, $n \times T1$

Summary

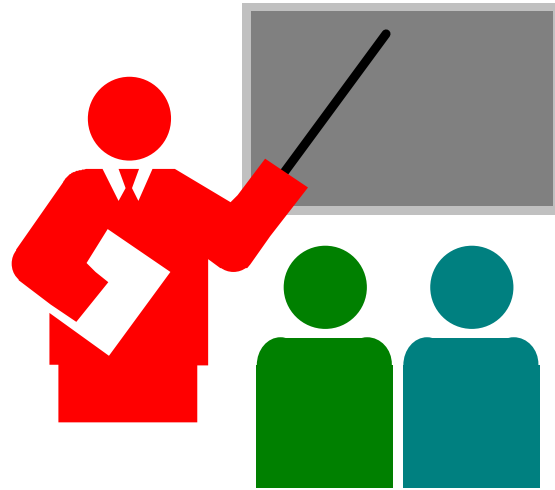

- ❑ ATM Overview: History, Why and What
- ❑ Protocol Layers: AAL, ATM, Physical layers, Cell format
- ❑ Interfaces: PNNI, NNI, B-ICI, DXI

Homework

- ❑ Read Sections 11.1-11.5 of Stallings
- ❑ Submit answers to Exercise 11.4