

X.25

Raj Jain

**Raj Jain is now at
Washington University in Saint Louis
Jain@cse.wustl.edu
<http://www.cse.wustl.edu/~jain/>**



- ❑ X.25 Overview
- ❑ X.25 Protocol Layers
- ❑ X.25 Physical Layer
- ❑ X.25 Frame Level: LAPB
- ❑ X.25 Packet Level
- ❑ Call Setup/Disconnection

X.25 Overview

- ❑ First packet switching interface.
- ❑ Issued in 1976 and revised in 1980, 1984, 1988, and 1992.
- ❑ Data Terminal Equipment (DTE) to Data Communication Equipment (DCE) interface
⇒ User to network interface (UNI)
- ❑ Used universally for interfacing to packet switched networks

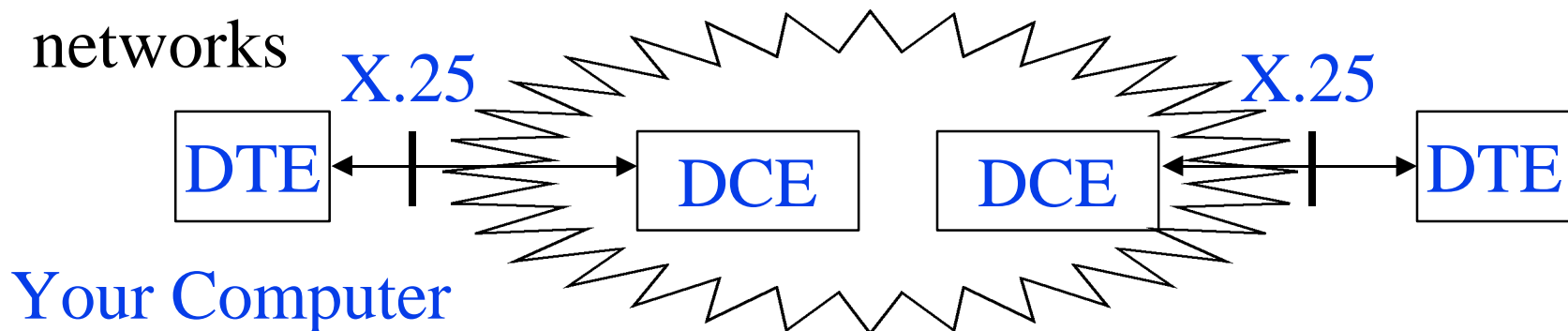

Virtual Circuits

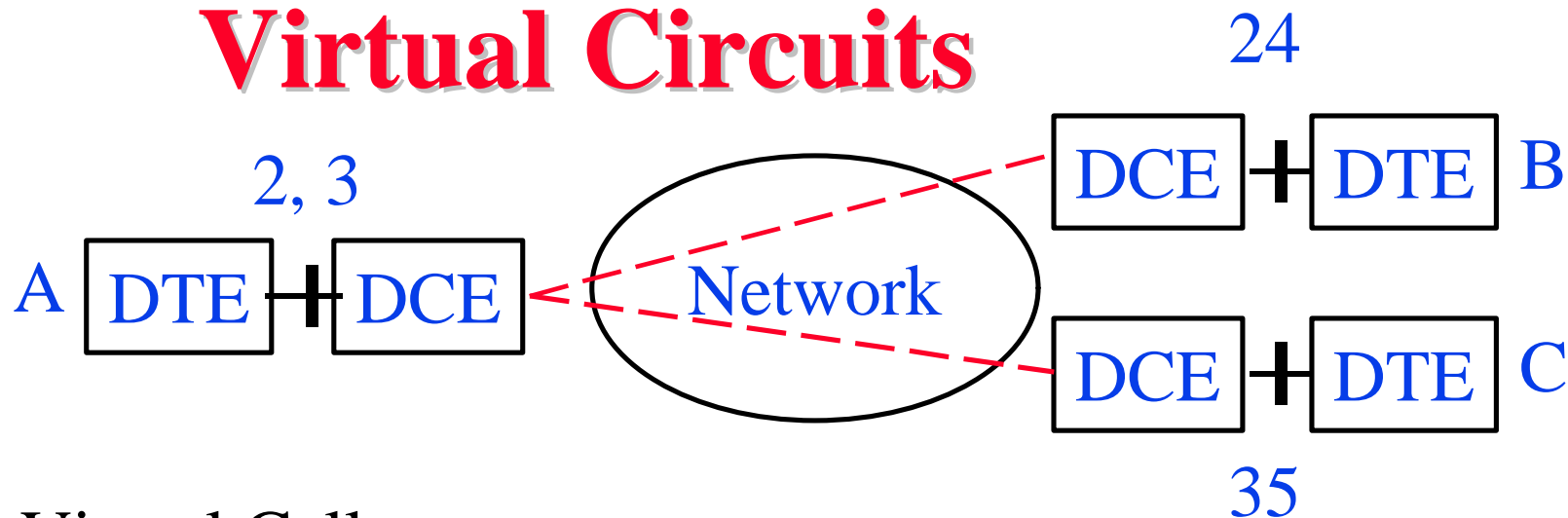

- ❑ Virtual Call
- ❑ Two Types of Virtual Circuits:
 - Switched virtual circuit (SVC)
Similar to phone call
 - Permanent virtual circuit (PVC)
Similar to leased lines
- ❑ Up to 4095 VCs on one X.25 interface

X.25 Protocol Layers

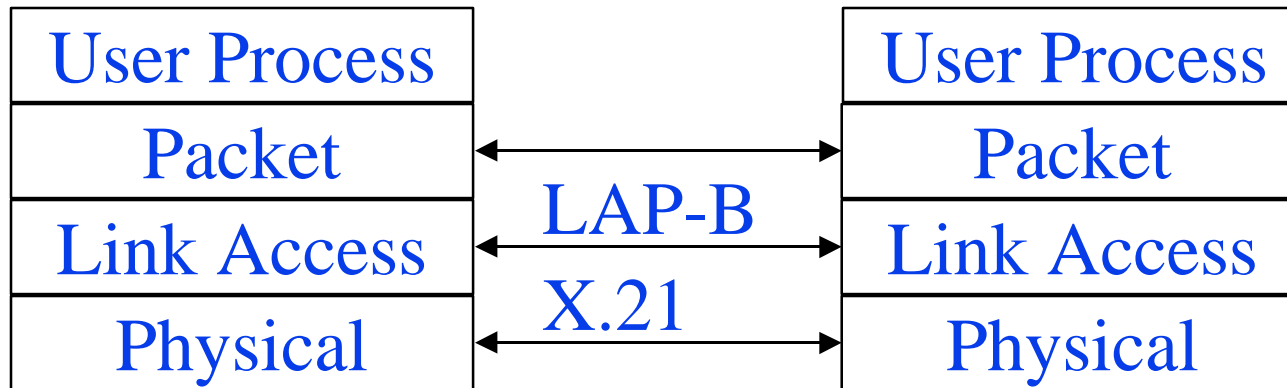

DTE

DCE

- ❑ X.21 often replaced by EIA-232 (RS-232C)
- ❑ LAP-B = Link access procedure - Balanced
- ❑ Packet layer = Connection-oriented **transport** over virtual circuits

Protocol Layers (Cont)

- ❑ X.25 Packets
- ❑ Data is broken into blocks
- ❑ 3- or 4-byte packet header
- ❑ Packets are broken into LAPB frames

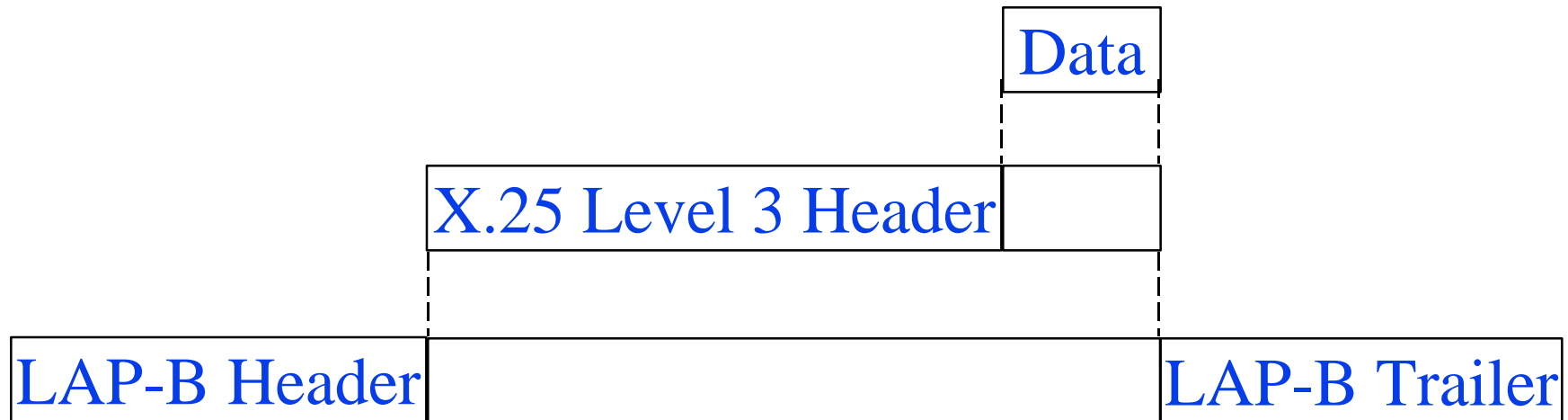

X.25 Physical Layer

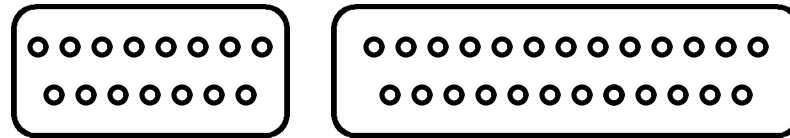

- ❑ Electrical and mechanical specifications of the interface
- ❑ X.21 = 15-pin digital recommendation
- ❑ X.21bis = X.21 twice = X.21 second **Interim** analog specification to allow existing equipment to be upgraded.
Now more common than X.21 \Rightarrow X.21 Rev 2
- ❑ RS-232-C developed by Electronics Industries Association of America (EIA) is most common
Uses 25-pin connector. Commonly used in PCs.

HDLC Family

- ❑ Synchronous Data Link Control (SDLC): IBM
- ❑ High-Level Data Link Control (HDLC): ISO
- ❑ Link Access Procedure-Balanced (LAPB): X.25
- ❑ Link Access Procedure for the D channel (LAPD): ISDN
- ❑ Link Access Procedure for modems (LAPM): V.42
- ❑ Link Access Procedure for half-duplex links (LAPX): Teletex
- ❑ Point-to-Point Protocol (PPP): Internet
- ❑ Logical Link Control (LLC): IEEE
- ❑ Advanced Data Communications Control Procedures (ADCCP): ANSI
- ❑ V.120 and Frame relay also use HDLC

HDLC



- ❑ Primary station: Issue commands
- ❑ Secondary Station: Issue responses
- ❑ Combined Station: Both primary and secondary
- ❑ Unbalanced Configuration: One or more secondary
- ❑ Balanced Configuration: Two combined station
- ❑ Normal Response Mode (NRM): Response from secondary
- ❑ Asynchronous Balanced Mode (ABM): Combined Station
- ❑ Asynchronous Response Mode (ARM): Secondary may respond before command

LAPB

- ❑ Uses balanced mode subset of HDLC between DTE and DCE
- ❑ Uses 01111110 as frame delimiter
Uses bit stuffing to avoid delimiters inside the frames
- ❑ Uses HDLC frame format
- ❑ Point-to-point: Only two stations - DTE (A), DCE (B)
Addresses: A=00000011, B=00000001
Address = Destination Addresses in Commands

Source Address in Responses,

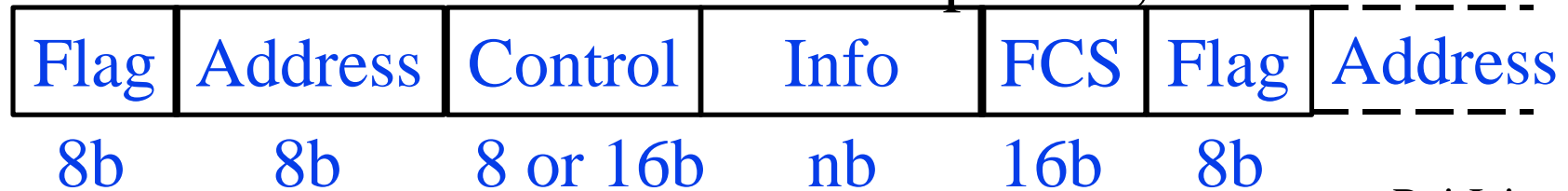

Control Field Format

	1	2	3	4	5	6	7	8
Information	0	N(S)			P/F	N(R)		
Supervisory	1	0	S	P/F	N(R)			
Unnumbered	1	1	M	P/F	M			

- ❑ N(S) = Send Sequence Number
- ❑ N(R) = Receive Sequence Number = Expected next
- ❑ P/F = Poll/Final = Command/Response
- ❑ M = Set Async Balanced Mode (SABM), Disconnect, Unnumbered Ack, ...
- ❑ S = Supervisory function = Receiver Ready (RR), Receiver Not Ready (RNR), Reject (Rej)

HDLC Frames

- ❑ Information Frames: User data
 - Piggybacked Acks: Next frame expected
 - Poll/Final = Command/Response
- ❑ Supervisory Frames: Flow and error control
 - Go back N and Selective Reject
 - Final \Rightarrow No more data to send
- ❑ Unnumbered Frames: Control
 - Mode setting commands and responses
 - Information transfer commands and responses
 - Recovery commands and responses
 - Miscellaneous commands and responses

Examples of HDLC Operation

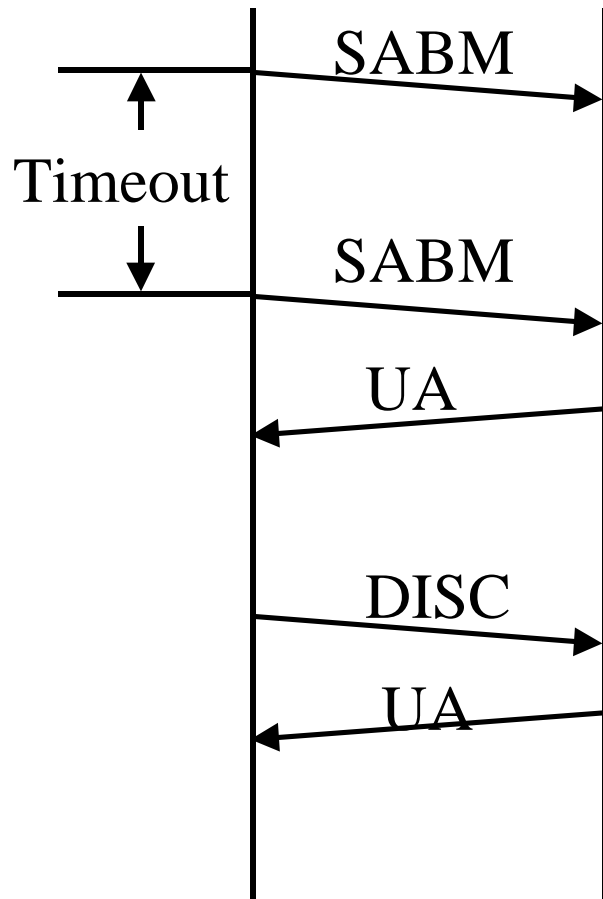

(a) Line setup and disconnect

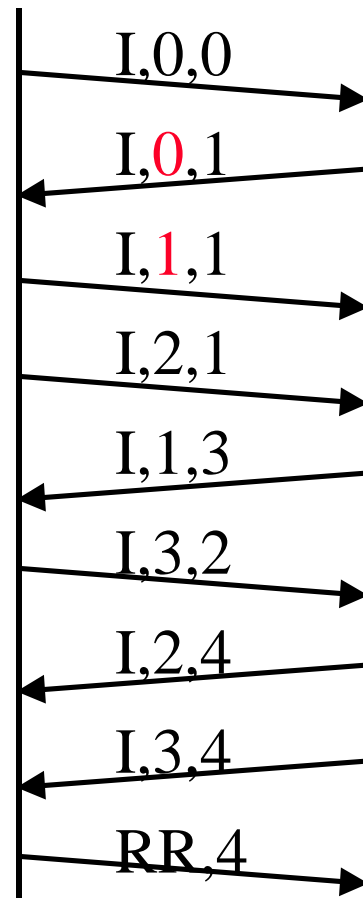

(b) Two-way data exchange

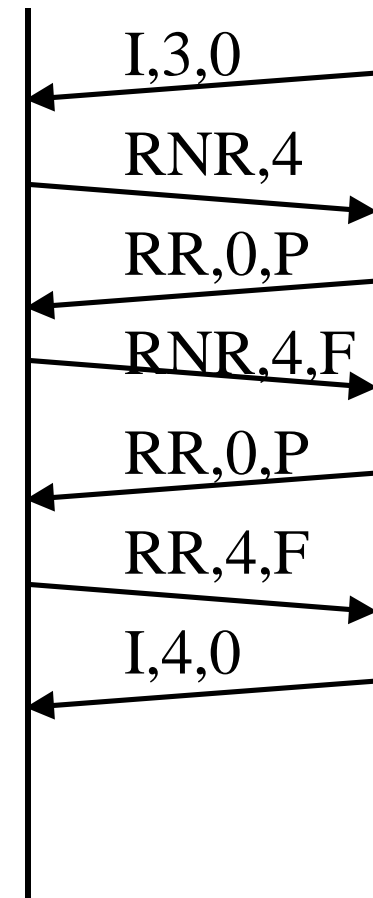

(c) Busy condition

Fig 6.12 Stallings

Raj Jain

Examples of Operation (Cont)

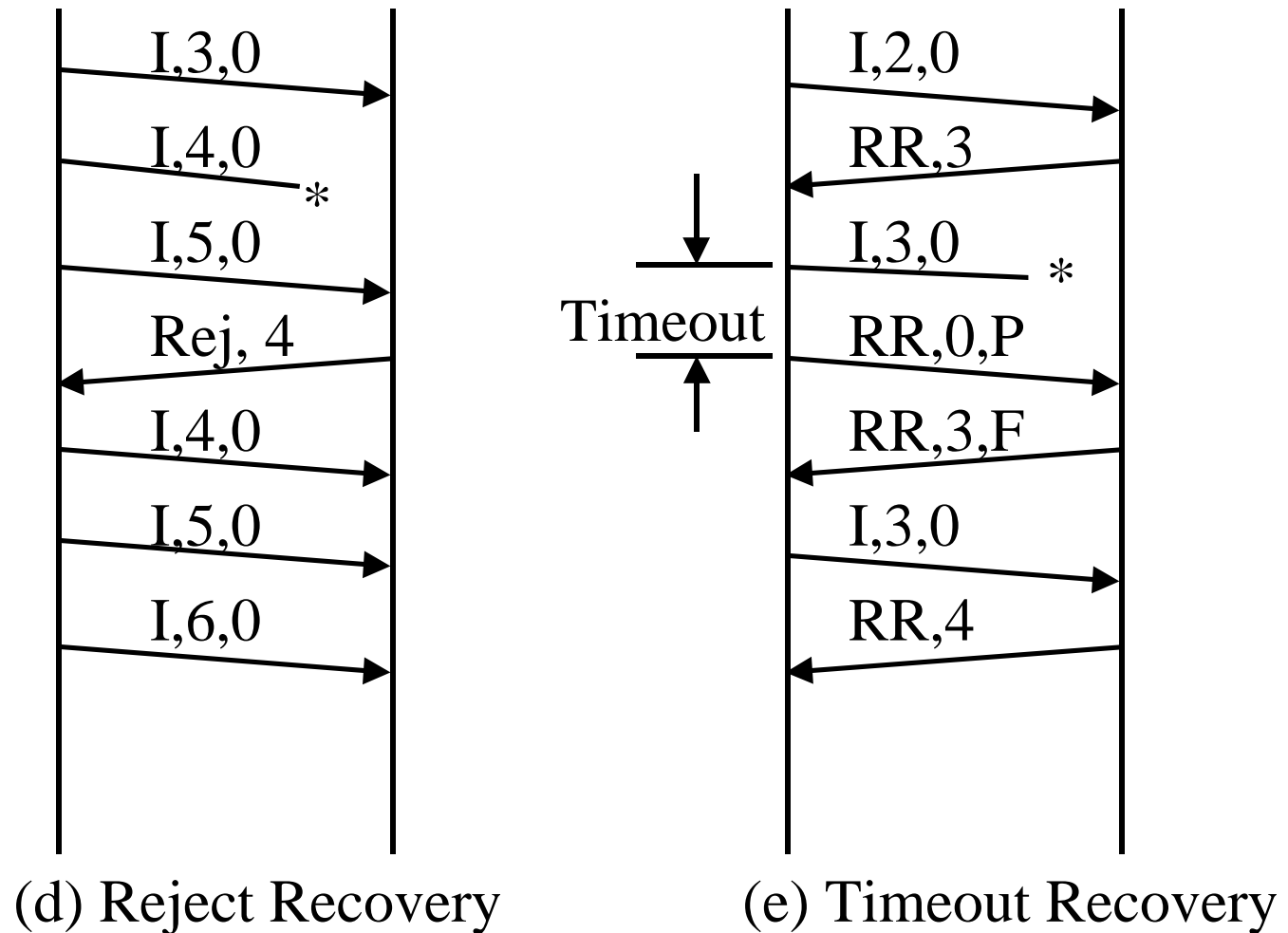

Fig 6.12 Stallings

Raj Jain

X.25 Packet Level

- ❑ Packet Level = End-to-end
- ❑ Packet level procedures:
 - Establishment and clearing of virtual calls
 - Management of PVCs
 - Flow Control
 - Recovery from error conditions

Call Setup/Disconnection

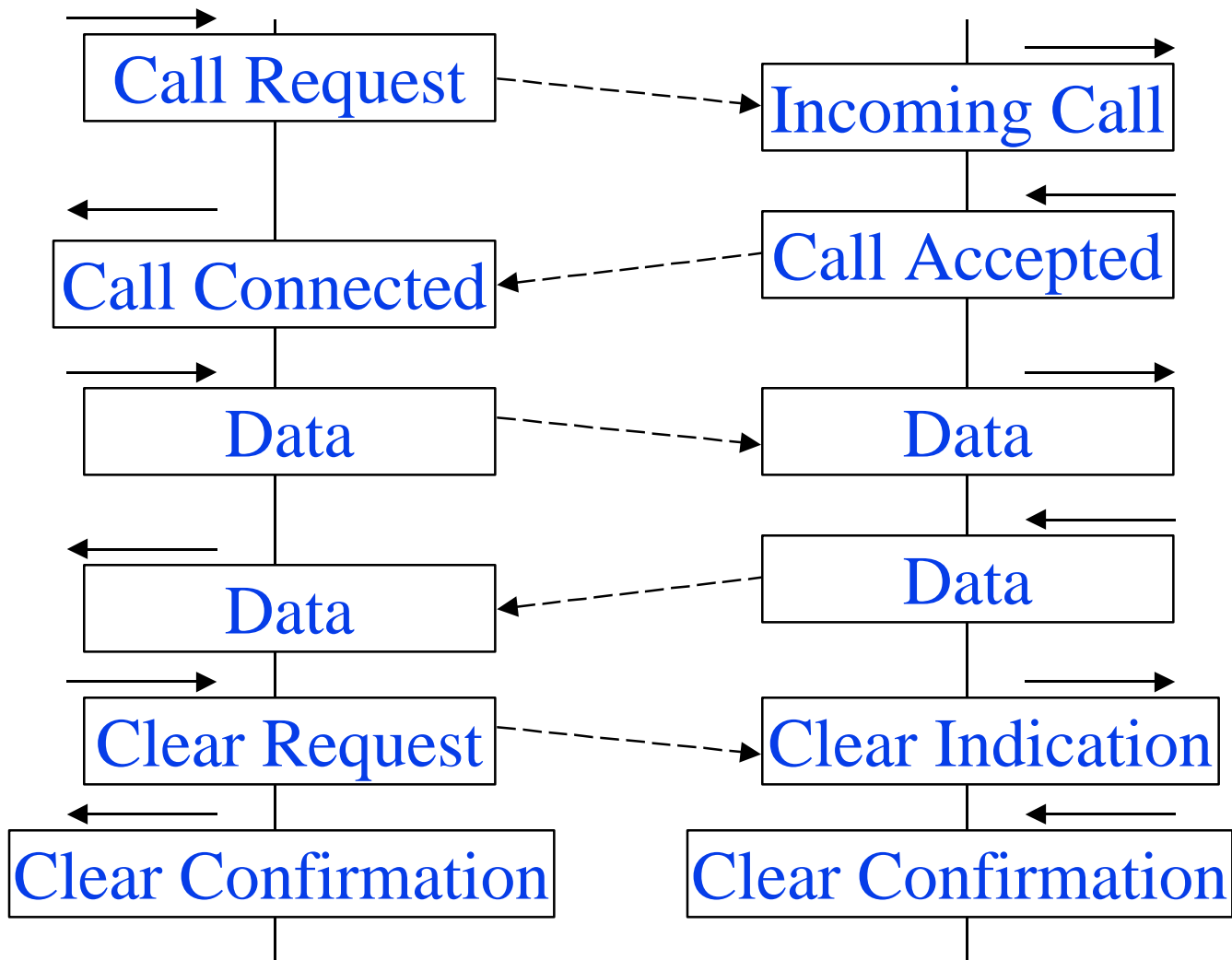

Packet Format

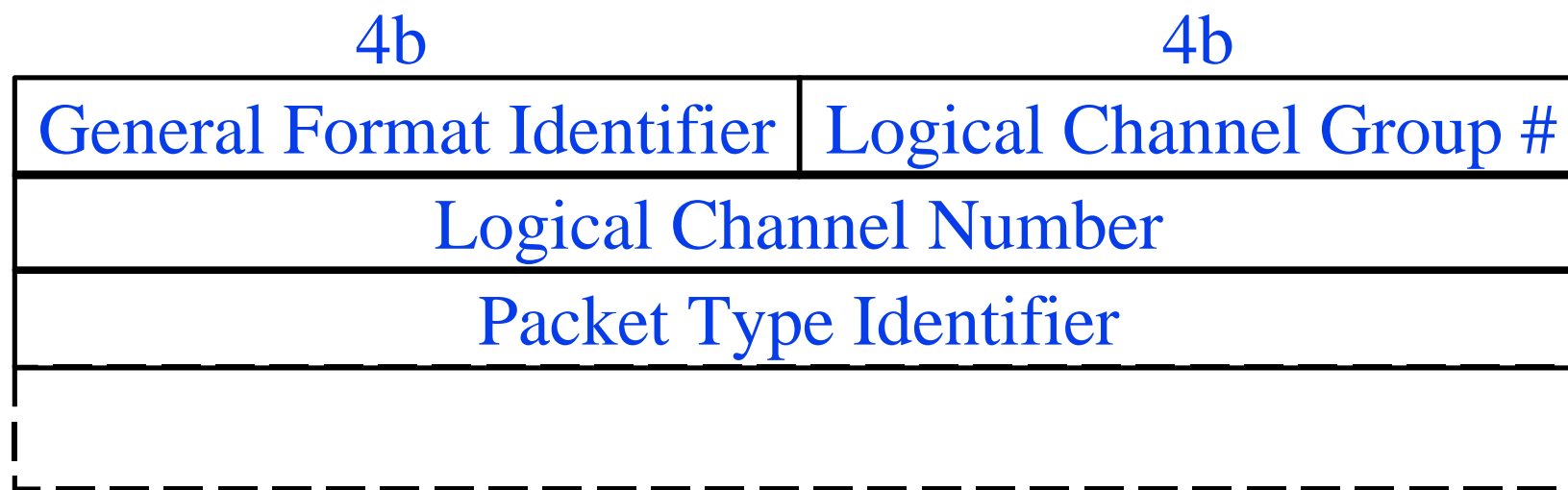

- ❑ GFI = Type of packet.
 - Bit 1: Qualifier. $Q=1 \Rightarrow$ Higher level control
 - Bit 2: $0 \Rightarrow$ End-to-end confirm., $1 \Rightarrow$ Local conf.
 - Bits 3,4: $01 \Rightarrow$ 3-bit or $10 \Rightarrow$ 7-bit sequence #
- ❑ LCGN + LCN = 12-bit VC # w 4-bit Group
- ❑ PTI = 20 possible packet types

Packet Format (Cont)

Q	D	0	1	Group #
Channel #				
P(R)		M	P(S)	
0				
User Data				

Data w 3-bit Seq #

q M = More segments

q P(R) and P(S) refer to packet sequence #

Different from N(R) and N(S) - frame sequence #

Q	D	1	0	Group #
Channel #				
P(S)				0
P(R)				M
User Data				

Data w 7-bit Seq #

Packet Format (Contd)

0	0	0	1	Group #
Channel #				
Packet Type				1
Additional Info				
Control w 3-bit Seq #				

0	0	0	1	Group #
Channel #				
P(R)		Pkt Type		1

RR, RNR, and REJ
packets with 3-bit seq #

0	0	1	0	Group #
Channel #				
Packet Type				1
Additional Info				
Control w 7-bit Seq #				

0	0	1	0	Group #
Channel #				
Pkt Type				1
P(R)				0

RR, RNR, and REJ
packets with 7-bit seq #

Summary

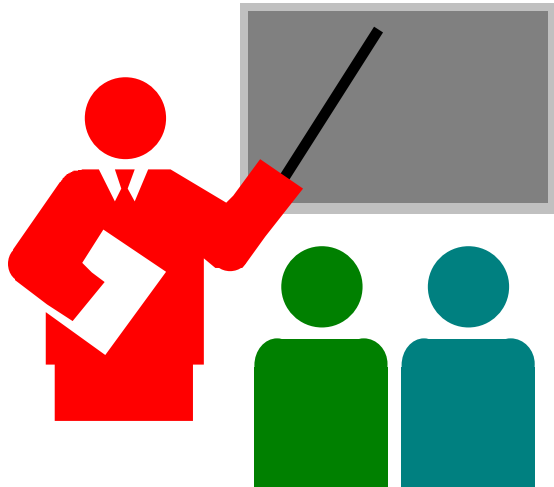

- ❑ X.21, LAPB
- ❑ PVC and virtual call
- ❑ VC numbers
- ❑ M and D bits

Homework

- ❑ Read pages 61-65 of Black's "Emerging Technologies" book
- ❑ Submit answer to the following question:
In X.25 why is the VC number used by one station is different from the VC number used by the other station? After all, it is the same full-duplex virtual circuit.
- ❑ Due Date: April 13, 1999

Additional References

- ❑ N. M. Thorpe and D. Ross, “X.25 Made Easy,” Prentice Hall, 1992, 192 pp.
- ❑ W. Stallings, “Data and Computer Communications,” 5th Edition, Prentice Hall, 1996, Sections 6.4 and 9.4