

The Network Layer: Control Plane

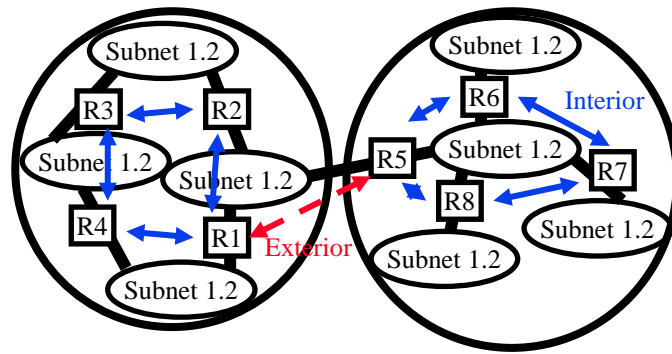

Raj Jain

Washington University in Saint Louis

Saint Louis, MO 63130

Jain@wustl.edu

Audio/Video recordings of this lecture are available on-line at:

<http://www.cse.wustl.edu/~jain/cse473-22/>

Student Questions

Note: Questions discussed during regular Q&A sessions are marked with □. New questions asked during Exam 2 review are marked with ❖



1. Routing Algorithms: Link-State, Distance Vector
Dijkstra's algorithm, Bellman-Ford Algorithm
2. Routing Protocols: OSPF, BGP
3. SDN Control Plane
4. ICMP
5. SNMP

Note: This class lecture is based on Chapter 5 of the textbook (Kurose and Ross) and the figures provided by the authors.

Student Questions

Network Layer Functions

- ❑ Forwarding: Deciding what to do with a packet using a routing table \Rightarrow Data plane
- ❑ Routing: Making the routing table \Rightarrow Control Plane

Student Questions



Routing Algorithms

1. Graph abstraction
2. Distance Vector vs. Link State
3. Dijkstra's Algorithm
4. Bellman-Ford Algorithm

Student Questions

Rooting or Routing

- ❑ *Rooting* is what fans do at football games, what pigs do for truffles under oak trees in the Vaucluse, and what nursery workers intent on propagation do to cuttings from plants.
- ❑ *Routing* is how one creates a beveled edge on a table top or sends a corps of infantrymen into full scale, disorganized retreat

Student Questions

Ref: Piscitello and Chapin, "Open Systems Networking: TCP/IP and OSI," Adison-Wesley, 1993, p413

Routeing or Routing

- ❑ Routeing: British
- ❑ Routing: American
- ❑ Since Oxford English Dictionary is much heavier than any other dictionary of American English, British English generally prevails in the documents produced by ISO and CCITT; wherefore, most of the international standards for routing standards use the routeing spelling.

Student Questions

Ref: Piscitello and Chapin, "Open Systems Networking: TCP/IP and OSI," Addison-Wesley, 1993, p413

Graph abstraction

- ❑ Graph: $G = (N, E)$
- ❑ $N =$ Set of routers
 $= \{ u, v, w, x, y, z \}$
- ❑ $E =$ Set of links
 $= \{ (u, v), (u, x), (u, w), (v, x), (v, w), (x, w), (x, y), (w, y), (w, z), (y, z) \}$
- ❑ Each link has a cost, e.g., $c(w, z) = 5$
- ❑ Cost of path $(x_1, x_2, \dots, x_p) = c(x_1, x_2) + c(x_2, x_3) + \dots + c(x_{p-1}, x_p)$
- ❑ Routing Algorithms find the least cost path
- ❑ We limit to “Undirected” graphs, i.e., cost is same in both directions

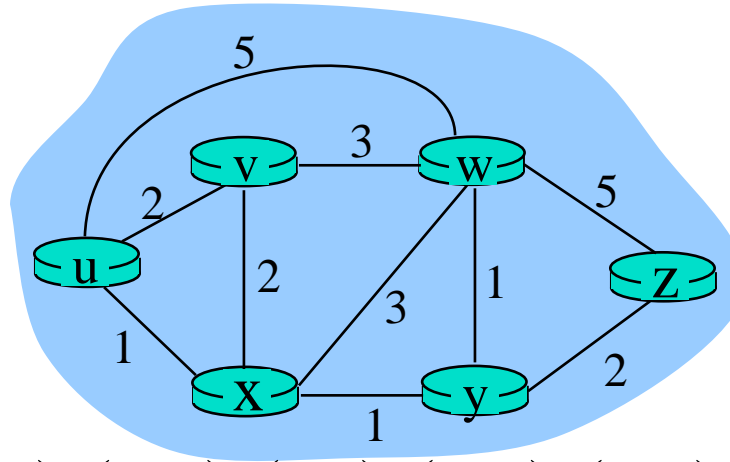

Student Questions

Distance Vector vs. Link State

Distance Vector:

- ❑ Vector of distances to all nodes, e.g.,
u: {u:0, v:2, w:5, x:1, y:2, z:4}
- ❑ Sent to neighbors, e.g.,
u will send to v, w, x
- ❑ Large vectors to small # of nodes
Tell about the world to neighbors
- ❑ Older method. Used in RIP.

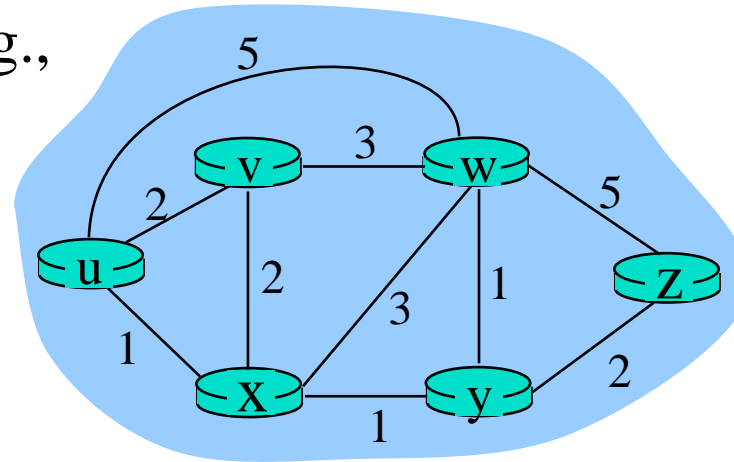

Link State:

- ❑ Vector of link cost to neighbors, e.g, u: {v:2, w:5, x:1}
- ❑ Sent to all nodes, e.g., u will send to v, w, x, y, z
- ❑ Small vectors to large # of nodes
Tell about the neighbors to the world
- ❑ Newer method. Used in OSPF.

Student Questions

- ❖ Is there a reason, other than the fact that link-state algorithms do not encounter counting-to-infinity problems, that link-state is preferable to distance-vector?
No. But, counting to infinity is a BIG problem.
- ❖ Will distance vector and link-state result in different routing tables?
No. The final answer is the same. But the number of iterations required to settle down after a change in the network is significantly different.

Dijkstra's Algorithm

- ❑ Goal: Find the least cost paths from a given node to all other nodes in the network
- ❑ Notation:
 - $c(i,j)$ = Link cost from i to j if i and j are connected
 - $D(k)$ = Total path cost from s to k
 - N' = Set of nodes so far for which the least cost path is known
- ❑ Method:
 - Initialize: $N' = \{u\}$, $D(v) = c(u,v)$ for all neighbors of u
 - Repeat until N includes all nodes:
 - ❑ Find node $w \notin N'$, whose $D(w)$ is minimum
 - ❑ Add w to N'

Student Questions

- ❑ Is Dijkstra's Algorithm ever implemented with min-priority queue in Networking?

Implementations are not standardized. So yes, someone may implement it using heaps.

- ❑ Is there any tradeoff between making it faster vs. the space required?

Yes. That's almost always true. Any computation can be made faster by caching.

- ❖ Is Dijkstra's algorithm run on every node in the network or just a subset of the nodes? It seems that there might be some re-work to run on every node since the paths might have overlapped when computing different nodes.

*The algorithm is run on every **router**. Paths may **change** while the algorithm is still in progress. If that happens, the router noticing the change will send its new table and the process will eventually end **iff** the configuration does not change again.*

Dijkstra's Algorithm: Example

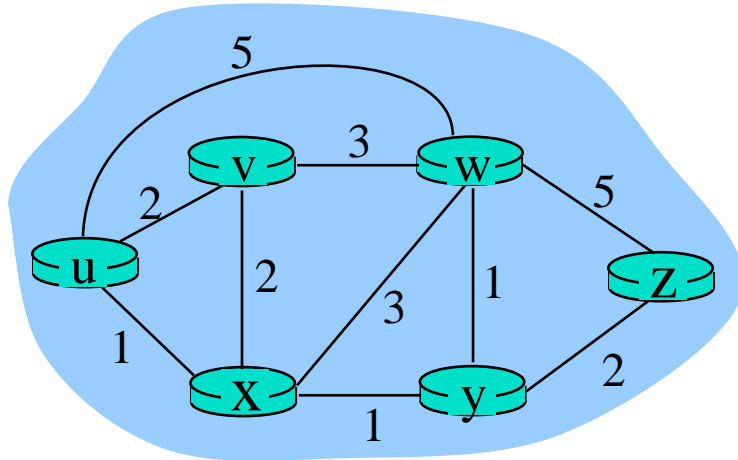

	N'	$D(v)$	Path	$D(w)$	Path	$D(x)$	Path	$D(y)$	Path	$D(z)$	Path
0	{u}	2	u-v	5	u-w	1	u-x	∞	-	∞	-
1	{u, x}	2	u-v	4	u-x-w			2	u-x-y	∞	-
2	{u, x, y}	2	u-v	3	u-x-y-w					4	u-x-y-z
3	{u, x, y, v}			3	u-x-y-w					4	u-x-y-z
4	{u, x, y, v, w}									4	u-x-y-z
5	{u, x, y, v, w, z}										

Student Questions

- ❖ Could you again go over the differences between Dijkstra's and Bellman-Ford Algorithm? Its easy to be confused about how exactly they are different.

Dijkstra broadcasts its link-state table to the entire network and computation proceeds hop by hop.

-Bellman-Ford broadcasts its distance vector to its neighbors. Computation continues until the distance vectors do not change.

-Link state tables are smaller than distance vectors.

-Link state tables have to be sent to the entire network. Distance vectors have to be sent only to neighbors.

- ❖ Can we go over another example of Dijkstra's algorithm?

You can make many variations of this graph by changing the costs or source node.

Complexity and Oscillations

- ❑ *Algorithm complexity: n nodes*
 - Each iteration: need to check all nodes, w , not in N
 - $n(n+1)/2$ comparisons: $O(n^2)$
 - More efficient implementations possible: $O(n \log n)$
- ❑ *Oscillations Possible: e.g., support link cost equals amount of carried traffic*

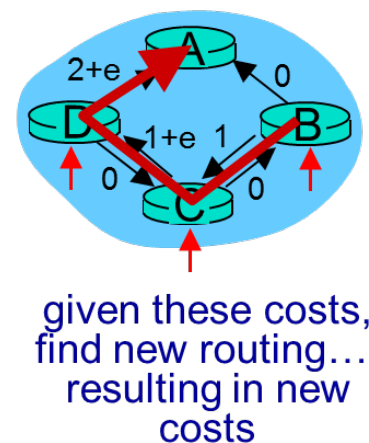
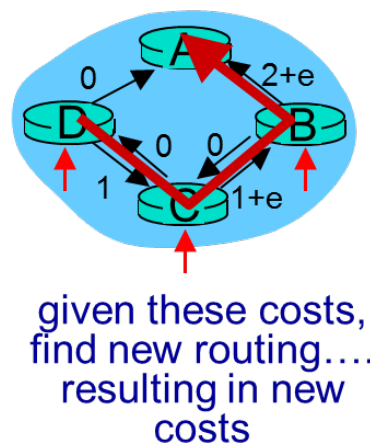
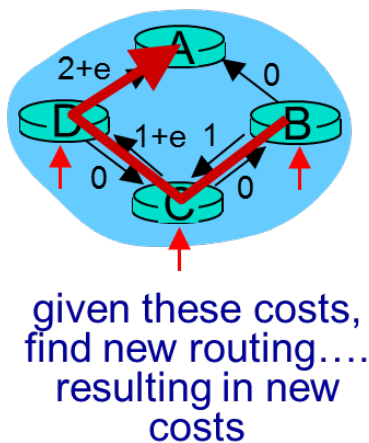
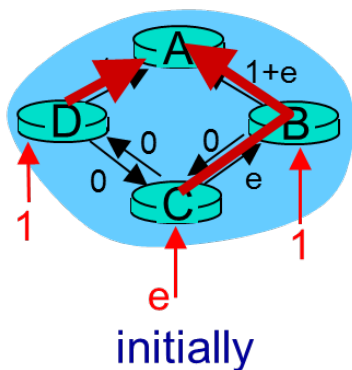

Student Questions

- ❑ Why is it $n+1$ in the complexity $n(n+1)/2$?
 $1+2+3+4+\dots+n = n(n+1)/2$
 - ❑ Is the n in the runtime for Dijkstra's algorithm the number of routers?
- Yes.
 $n = \text{number of nodes}$
-

Homework 5A

[12 points] Prepare the routing calculation *table* for node 1 in the following network using Dijkstra's algorithm. Explain how you computed new entries in each row.

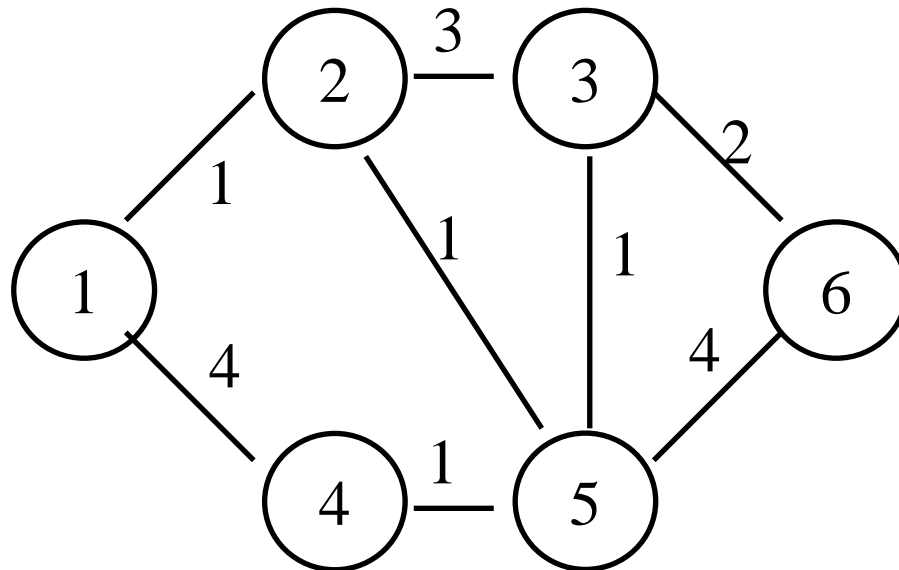

Student Questions

- Should the routing table look like the one on slide 10? Which entries should each node have?

No. Computation is shown slide 5-10. Routing tables were shown in Slide 4-4.

Prefix	Next Router	Interface
126.23.45.67/32	125.200.1.1	1
128.272.15/24	125.200.1.2	2
128.272/16	125.200.1.1	1

Bellman-Ford Algorithm

□ Notation:

u = Source node

$c(i,j)$ = link cost from i to j

h = Number of hops being considered

$D_u(n)$ = Cost of h -hop path from u to n

□ Method:

1. Initialize: $D_u(n) = \infty$ for all $n \neq u$; $D_u(u) = 0$

2. For each node: $D_u(n) = \min_j [D_u(j) + c(j,n)]$

3. If any costs change, repeat step 2

Student Questions

Bellman Ford Example 1

node x table

		cost to		
		x	y	z
from	x	0	2	7
	y	∞	∞	∞
	z	∞	∞	∞

node y table

		cost to		
		x	y	z
from	x	∞	∞	∞
	y	2	0	1
	z	∞	∞	∞

node z table

		cost to		
		x	y	z
from	x	∞	∞	∞
	y	∞	∞	∞
	z	7	1	0

		cost to		
		x	y	z
from	x	0	2	3
	y	2	0	1
	z	7	1	0

		cost to		
		x	y	z
from	x	0	2	7
	y	2	0	1
	z	7	1	0

		cost to		
		x	y	z
from	x	0	2	7
	y	2	0	1
	z	3	1	0

		cost to		
		x	y	z
from	x	0	2	3
	y	2	0	1
	z	3	1	0

		cost to		
		x	y	z
from	x	0	2	3
	y	2	0	1
	z	3	1	0

		cost to		
		x	y	z
from	x	0	2	3
	y	2	0	1
	z	3	1	0

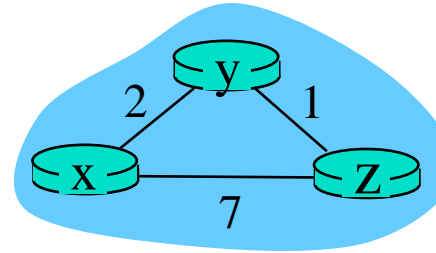

Student Questions

Bellman-Ford Example 2

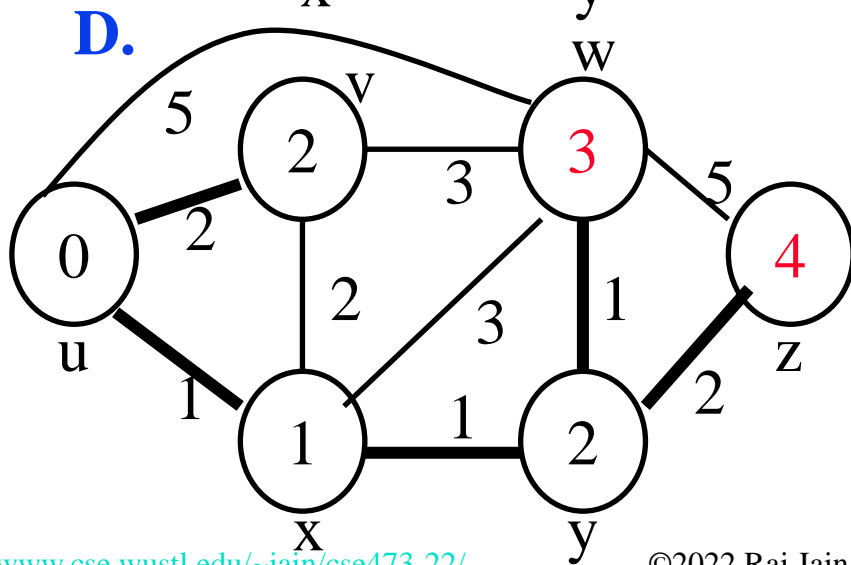
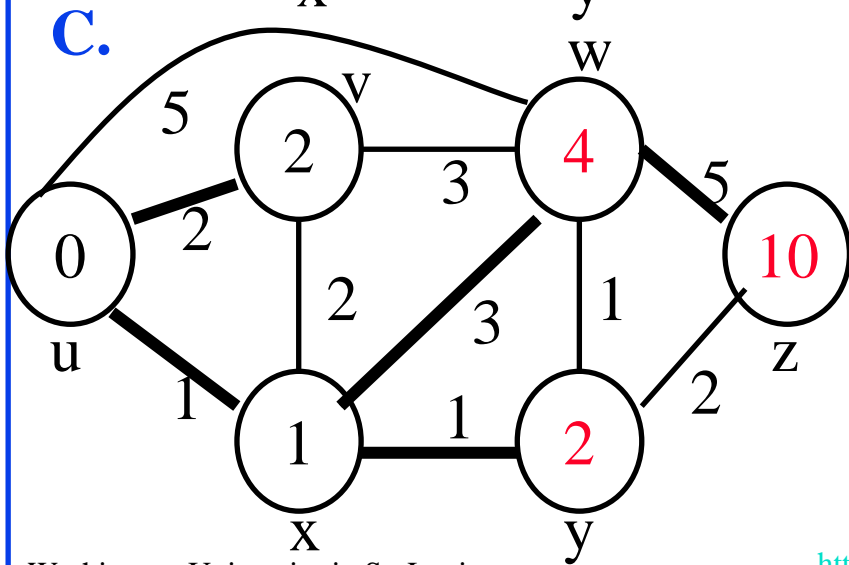
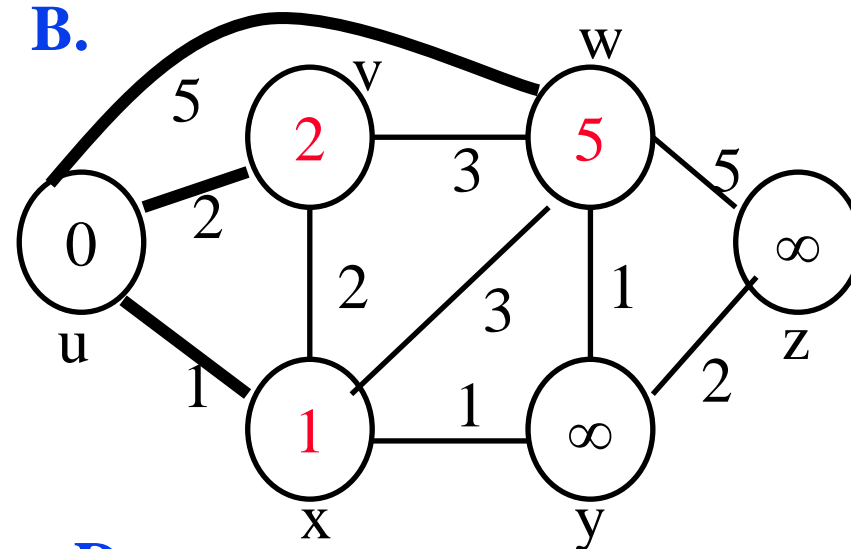
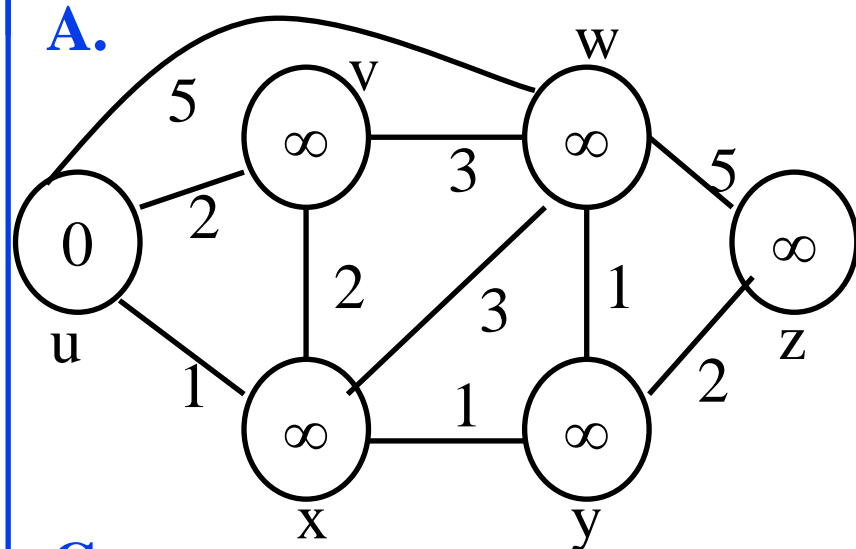

Student Questions

Bellman-Ford: Tabular Method

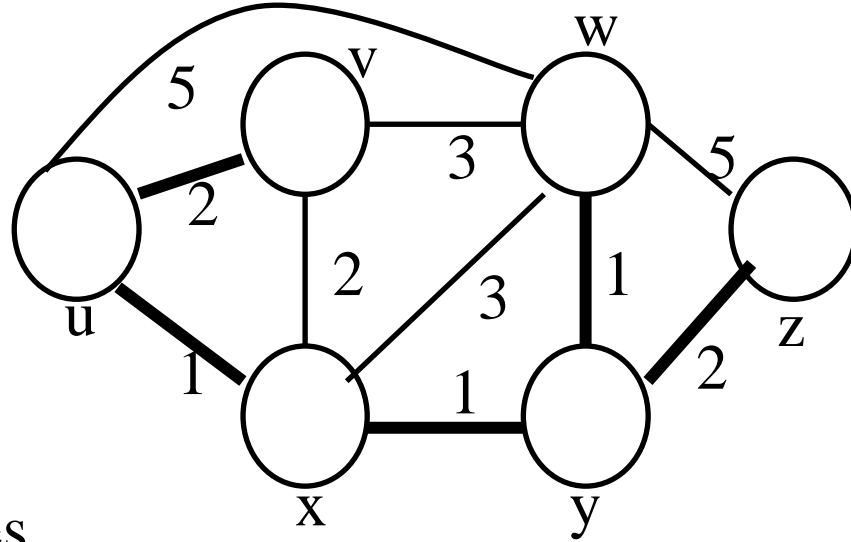

If cost changes
 \Rightarrow Recompute the costs to all neighbors

h	D(v)	Path	D(w)	Path	D(x)	Path	D(y)	Path	D(z)	Path
0	∞	-	∞	-	∞	-	∞	-	∞	-
1	2	u-v	5	u-w	1	u-x	∞	-	∞	-
2	2	u-v	4	u-x-v	1	u-x	2	u-x-y	10	u-w-z
3	2	u-v	3	u-x-y-w	1	u-x	2	u-x-y	4	u-x-y-z
4	2	u-v	3	u-x-y-w	1	u-x	2	u-x-y	4	u-x-y-z

Student Questions

- ❖ In the last iteration of the Bellman-Ford Algorithm, there is no update on the distance; what is this last iteration do?
Verifies that there is no update.

Counting to Infinity Problem

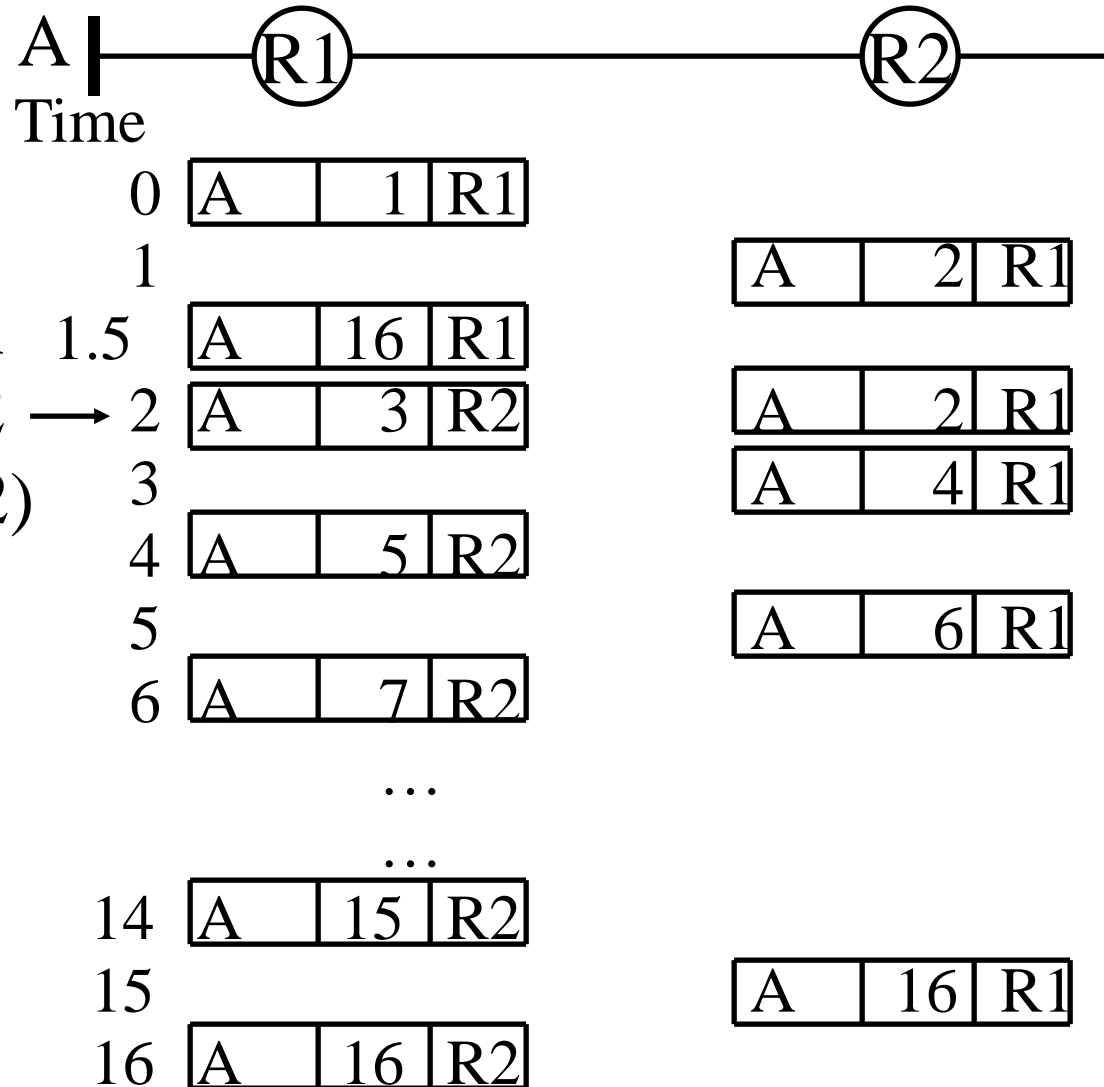

R1 loses A
 R1 hears from R2
 (Before it tells R2)

Student Questions

- ❖ How would routers combat a counting to infinity problem?
Using Link-State routing algorithms.

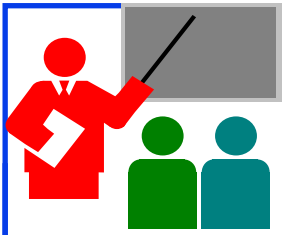

Routing Algorithms: Summary

1. Distance Vectors: Distance to all nodes in the network sent to neighbors. Small # of large messages.
2. Link State: Cost of link to neighbors sent to entire network. Large # of small messages.
3. Dijkstra's algorithm is used to compute shortest path using link state
4. Bellman Ford's algorithm is used to compute shortest paths using distance vectors
5. Distance Vector algorithms suffer from the count-to-infinity problem

Student Questions

- ❖ Could you explain again the meaning of link states algorithms send "Large # of small messages" and distance vector algorithms send "Small # of large messages."
 - Link state tables consist of the cost of each link connected to that router. The size is small. But it has to be broadcast to the entire network.
 - Distance vectors consist of distances to all nodes in the network. The size can be huge. But it has to be sent only to neighbors.

Ref: Read Section 5.2 of the textbook and try review questions R3-R6.

Washington University in St. Louis

<http://www.cse.wustl.edu/~jain/cse473-22/>

©2022 Raj Jain

Homework 5B

[10 points] Prepare the routing calculation table for node 1 in the following network using the Bellman-Ford Algorithm. Explain how you computed new entries in each row.

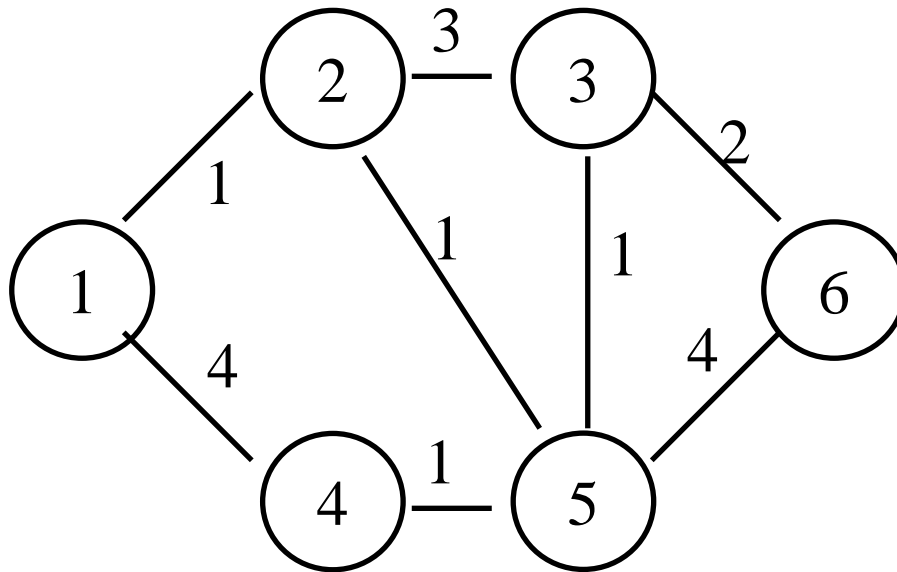

Student Questions



Routing Protocols

1. Autonomous Systems (AS)
2. Open Shortest Path First (OSPF)
 - OSPF Areas
3. Border Gateway Protocol (BGP)

Student Questions

Autonomous Systems

- An internet connected by homogeneous routers under the administrative control of a single entity

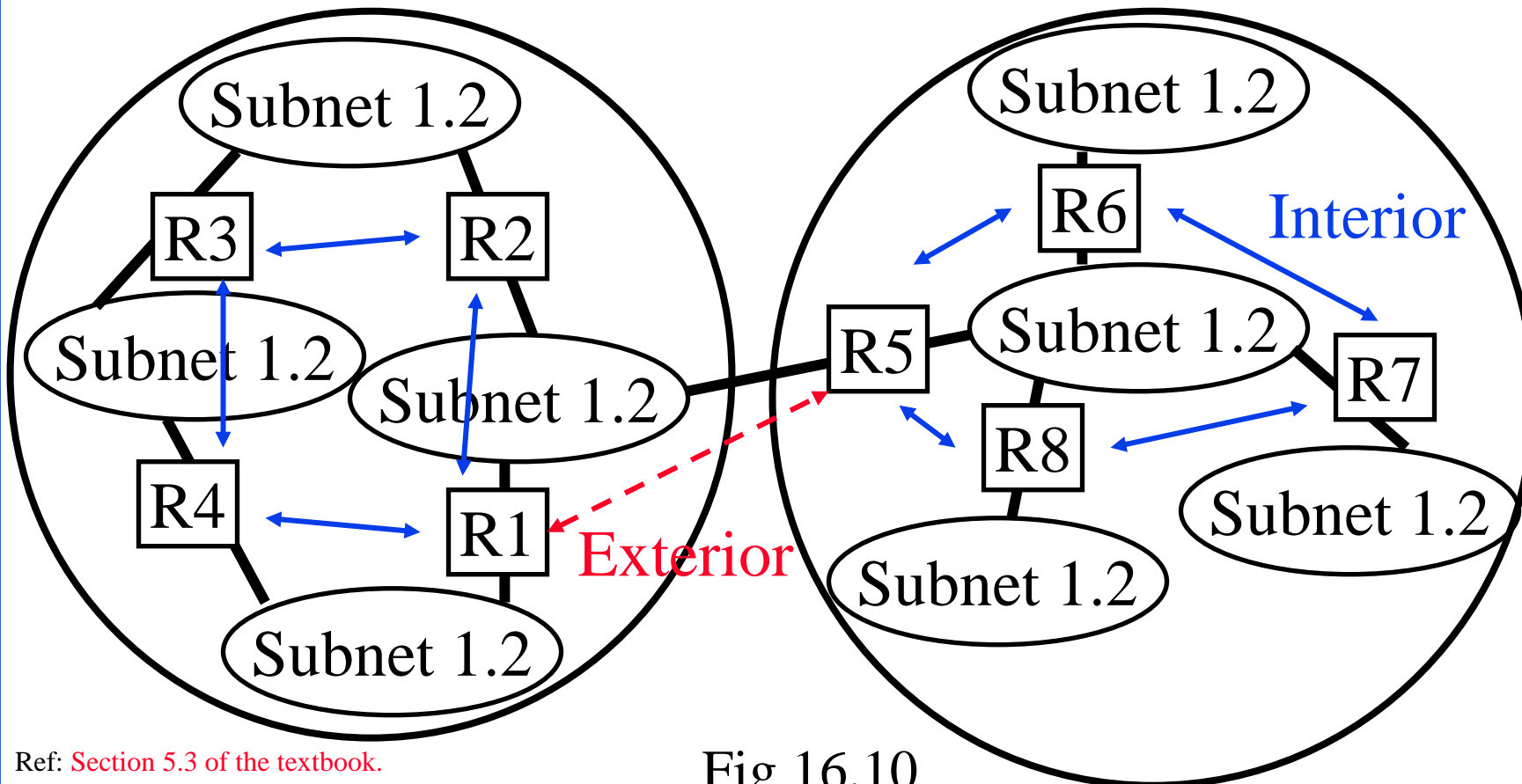

Fig 16.10

Ref: Section 5.3 of the textbook.

Student Questions

- ❖ Is an Autonomous System just an area owned by an ISP?

An enterprise or an ISP can own an autonomous system. For example, WUSTL.edu could be one autonomous system. WUSTL is not an ISP. It is an enterprise customer. Actually, WUSTL.edu consists of at least two autonomous systems: Med school and Danforth.

Routing Protocols

- ❑ Interior Router Protocol (IRP): Used for passing routing information among routers internal to an autonomous system. Also known as IGP.
 - Examples: RIP, OSPF, IGRP
- ❑ Exterior Router Protocol (ERP): Used for passing routing information among routers between autonomous systems. Also known as EGP.
 - Examples: EGP, BGP, IDRP
 - Note: EGP is a class as well as an instance in that class.

Student Questions

Open Shortest Path First (OSPF)

- ❑ Uses true metrics (not just hop count)
- ❑ Uses subnet masks
- ❑ Allows load balancing across equal-cost paths
- ❑ Supports type of service (ToS)
- ❑ Allows external routes (routes learnt from other autonomous systems)
- ❑ Authenticates route exchanges
- ❑ Quick convergence
- ❑ Direct support for multicast
- ❑ Link state routing \Rightarrow Each router broadcasts its connectivity with neighbors to entire network

Student Questions

- ❖ What do you mean by saying using true metrics?

Hop count does not reflect the cost. Some hops are more expensive than other hops. True metrics would reflect actual costs.

- ❖ Doesn't IP-anycast violate the rule that computers need to have different IP addresses?

-Anycast means “to anyone” in the set. For example, anycasting a question “What time is it?” to students in this class will result in a response from any one of the students. One response is sufficient in this case.

-Multicast means to “everyone” in the set. For example, “please submit your questions by midnight” needs to be multicast. Anycast will not work. Individual IPs will be too much work.

OSPF Areas

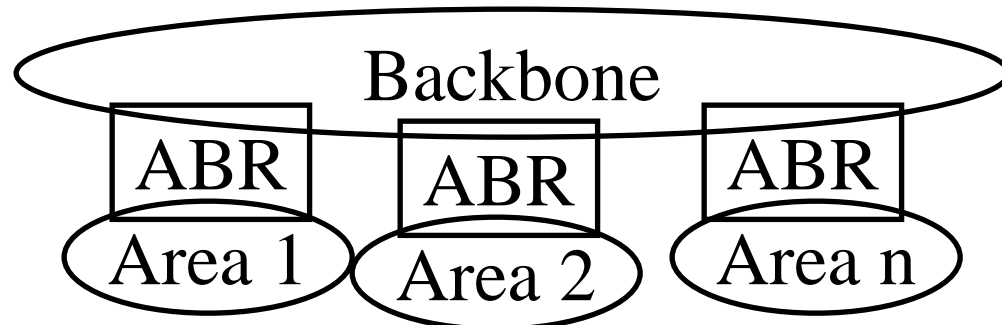

- ❑ Large networks are divided into areas to reduce routing traffic.
- ❑ LSAs are flooded throughout the area
- ❑ Area border routers (ABRs) summarize the topology and transmit it to the backbone area
- ❑ Backbone routers forward it to other areas
- ❑ ABRs connect an area with the backbone area.
ABRs contain OSPF data for all backbone areas.
- ❑ If there is only one area in the AS, there is no backbone area and there are no ABRs.

Student Questions

Border Gateway Protocol

- ❑ Inter-autonomous system protocol [RFC 1267]
- ❑ Used since 1989 but not extensively until recently
- ❑ Runs on TCP (segmentation, reliable transmission)
- ❑ Advertises all transit ASs on the path to a destination address
- ❑ A router may receive multiple paths to a destination \Rightarrow Can choose the best path
- ❑ iBGP used to forward paths inside the AS.
eBGP used to exchange paths between ASs.

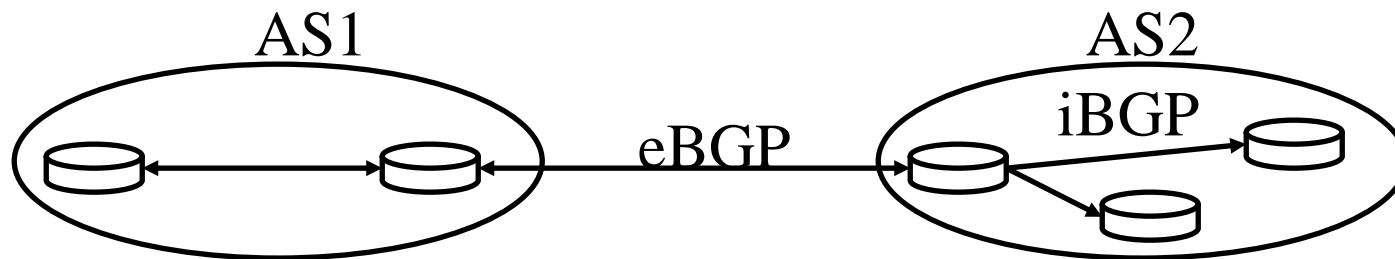

Ref: Section 5.4 of the textbook.

Washington University in St. Louis

<http://www.cse.wustl.edu/~jain/cse473-22/>

©2022 Raj Jain

Student Questions

BGP Operations

- ❑ BGP systems initially exchange entire routing tables. Afterwards, only updates are exchanged.
- ❑ BGP messages have the following information:
 - Origin of path information: RIP, OSPF, ...
 - AS_Path: List of ASs on the path to reach the dest
 - Next_Hop: IP address of the border router to be used as the next hop to reach the dest
 - Unreachable: If a previously advertised route has become unreachable
- ❑ BGP speakers generate update messages to all peers when it selects a new route or some route becomes unreachable.

Student Questions

BGP Routing Policy Example

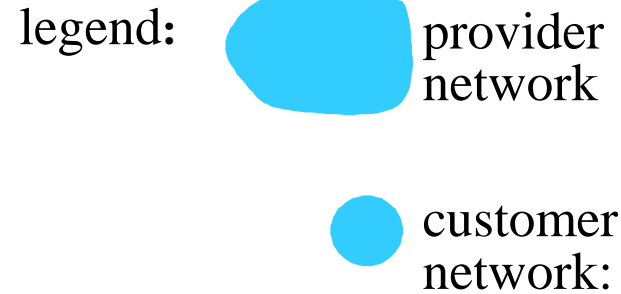
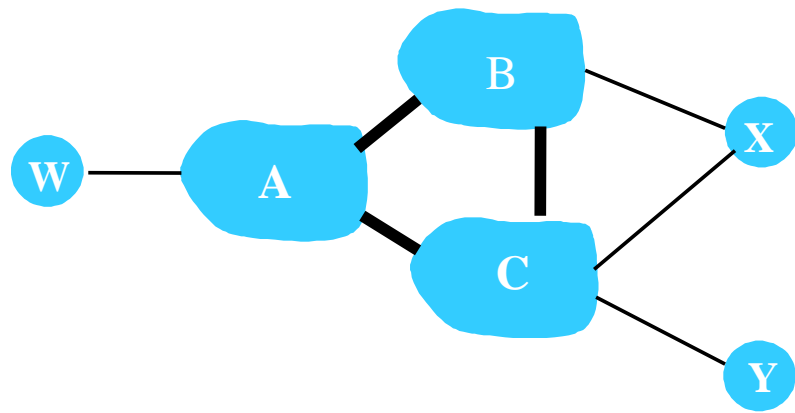



- ❑ A,B,C are **provider networks**
- ❑ X,W,Y are customer (of provider networks)
- ❑ X is **dual-homed**: attached to two networks
 - X does not want to route from B via X to C
 - .. so X will not advertise to B a route to C

Student Questions

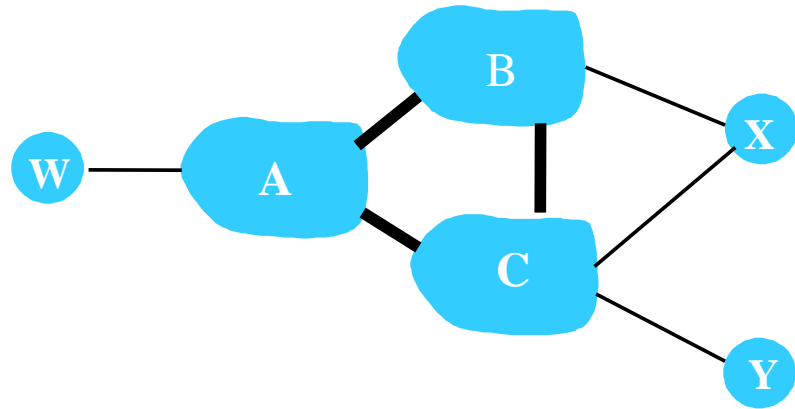
BGP Routing Policy Example (Cont)



legend:  provider network
 customer network:

- ❑ A advertises path A-W to B
- ❑ B advertises path B-A-W to X
- ❑ Should B advertise path B-A-W to C?
 - No way! B gets no “revenue” for routing C-B-A-W since neither W nor C are B’s customers
 - B wants to force C to route to w via A
 - B wants to route *only* to/from its customers!

Student Questions

Intra- vs. Inter-AS Routing

□ Policy:

- Inter-AS: admin wants control over how its traffic routed, who routes through its net.
- Intra-AS: single admin, so no policy decisions needed

□ Scale:

- Hierarchical routing saves table size, reduced update traffic

□ Performance:

- Intra-AS: can focus on performance
- Inter-AS: policy may dominate over performance

Student Questions

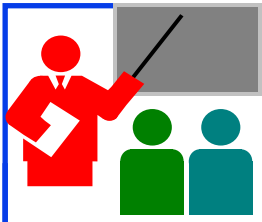

Routing Protocols: Summary

1. OSPF uses link-state routing and divides the autonomous systems into multiple areas.
Area border router, AS boundary router, designated router
2. BGP is an inter-AS protocol \Rightarrow Policy driven

Student Questions

Ref: Read Section 5.3 and 5.4 of the textbook and try review questions R7-R13.

Washington University in St. Louis

<http://www.cse.wustl.edu/~jain/cse473-22/>

©2022 Raj Jain

SDN Control Plane

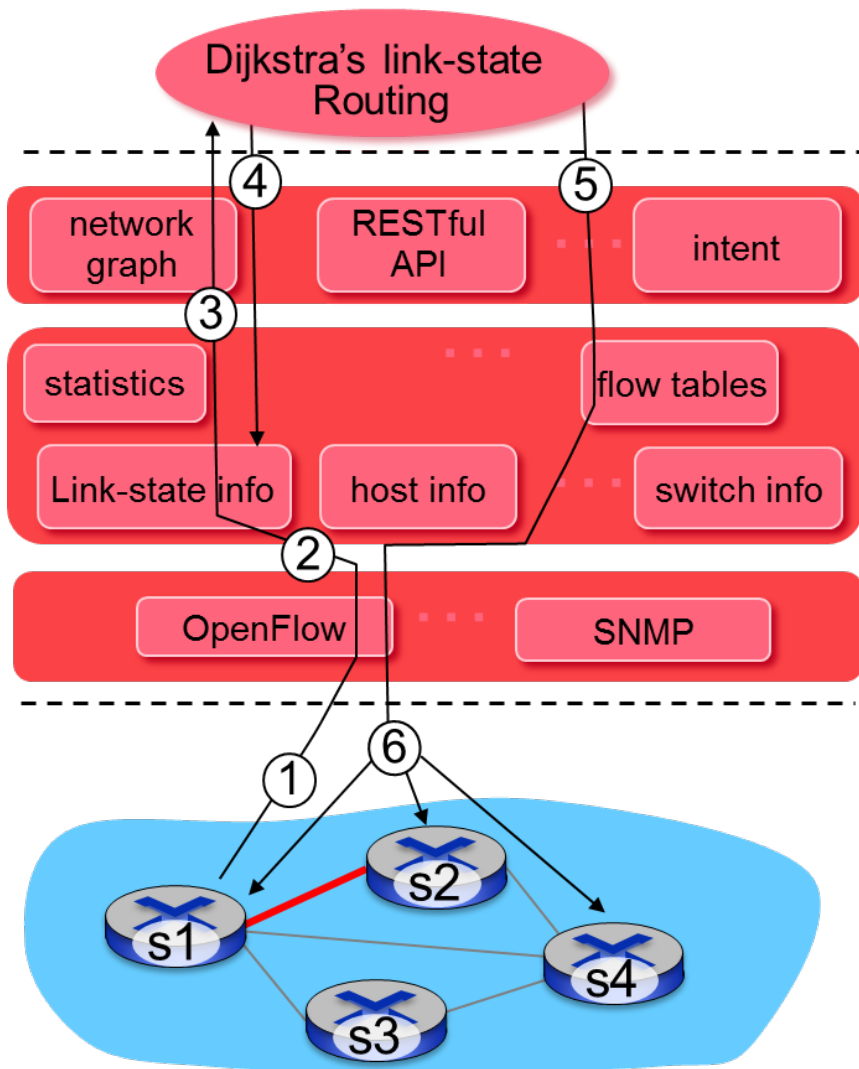

- ① S1, experiencing link failure using OpenFlow port status message to notify controller
- ② SDN controller receives OpenFlow message, updates link status info
- ③ Dijkstra's routing algorithm application has previously registered to be called when ever link status changes. It is called.
- ④ Dijkstra's routing algorithm access network graph info, link state info in controller, computes new routes

Student Questions

Controller Example: OpenDaylight

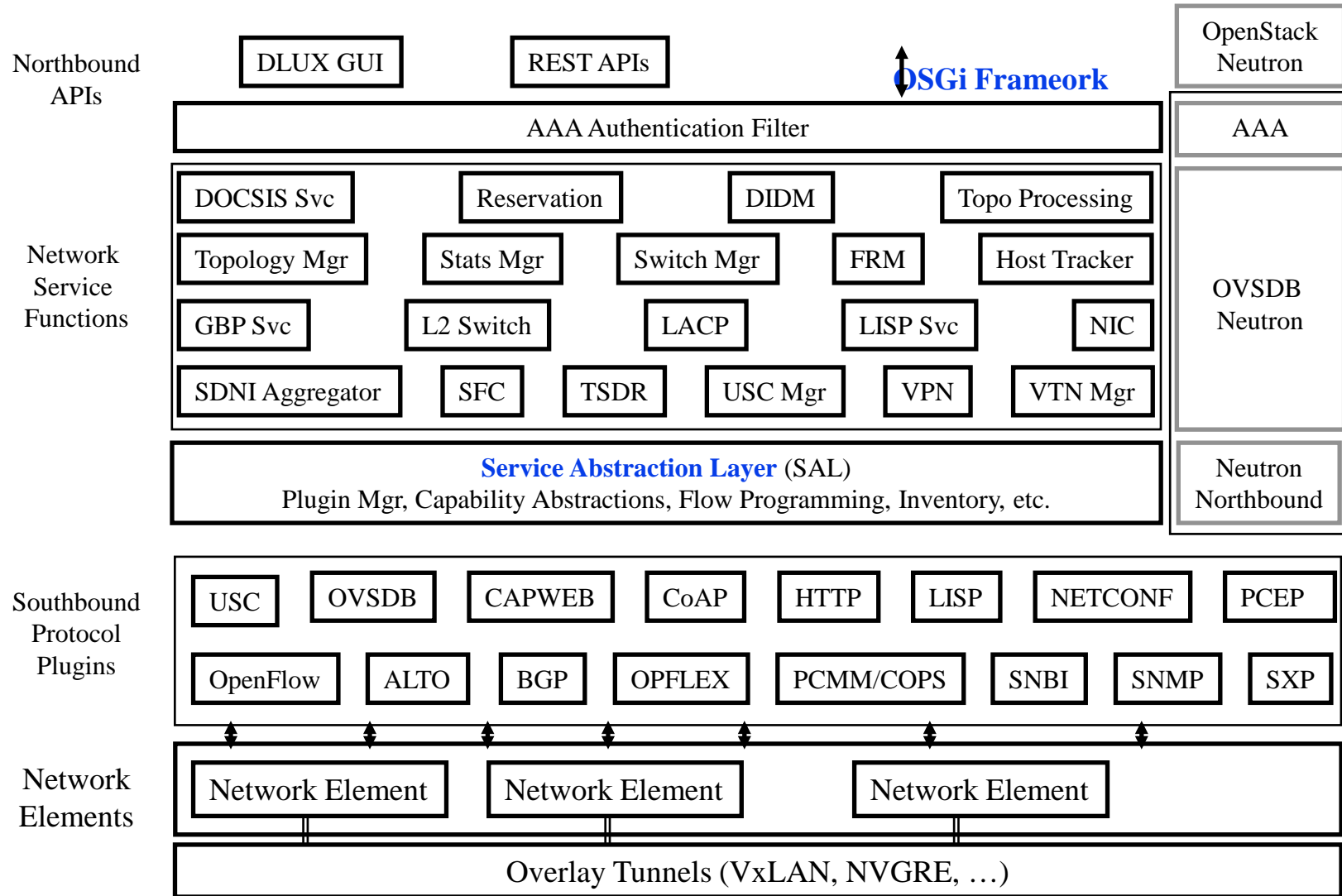

Student Questions

- ❖ Is the SAL responsible for translating Northbound APIs into Southbound Protocol Plugins?
It is responsible for translating and submitting network service function requests to southbound protocol plugins. Also, it is responsible for translating and submitting responses from southbound protocol plugins to network service functions.

OpenDaylight SDN Controller

- ❑ Multi-company collaboration under Linux foundation
- ❑ Many projects including OpenDaylight Controller
- ❑ Dynamically linked in to a Service Abstraction Layer (SAL)
⇒ SAL figures out how to fulfill the service requested by higher layers irrespective of the southbound protocol
- ❑ Modular design
- ❑ A rich set of North-bound APIs via **RESTful** (Web page like) services

Student Questions

Ref: **Read Section 5.5 and try review questions R14-R18.**

Washington University in St. Louis

<http://www.cse.wustl.edu/~jain/cse473-22/>

©2022 Raj Jain

ICMP

- ❑ Internet Control Message Protocol
- ❑ Required companion to IP. Provides feedback from the network.
- ❑ ICMP: Used by IP to send error and control messages
- ❑ ICMP uses IP to send its messages (Not UDP)
- ❑ ICMP does not report errors on ICMP messages.
- ❑ ICMP reports error only on the first fragment

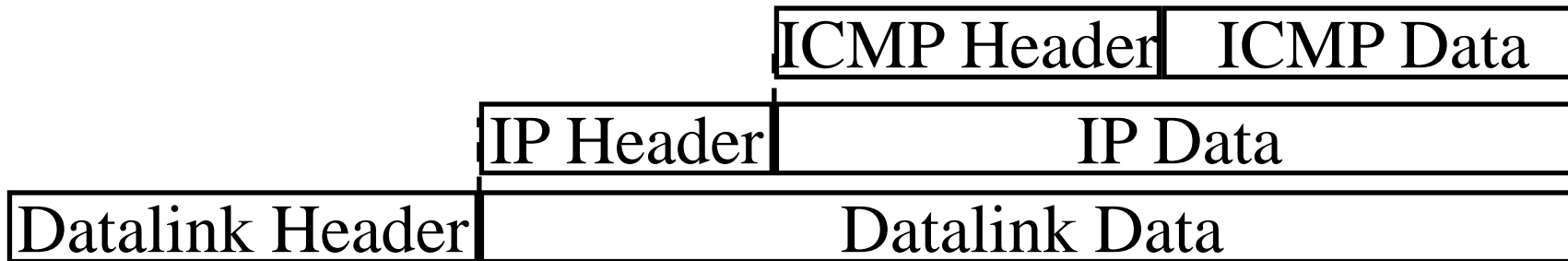

Student Questions

- ❖ Can we say ICMP is a layer 3.5 protocol?
Not really. It is a component of the Layer 3 protocol. IP cannot run without ICMP. Generally, each layer needs its management and security protocols. Sometimes these are built-in. In other cases, separate and many different standards (protocols) exist.

ICMP: Message Types

IP Header	
Type of Message	8b
Error Code	8b
Checksum	16b
Parameters, if any	Var
Information	Var

Type	Message
0	Echo reply
3	Destination unreachable
4	Source quench
5	Redirect
8	Echo request
11	Time exceeded
12	Parameter unintelligible
13	Time-stamp request
14	Time-stamp reply
15	Information request
16	Information reply
17	Address mask request
18	Address mask reply

Student Questions

❖ Can you explain more about the error packet?

ICMP Messages have "Type," which indicates what that message is for. Not all ICMP messages are "Error messages." The error code field indicates the type of error encountered while processing a datagram.

ICMP Messages

- ❑ Source Quench: Please slow down!
I just dropped one of your datagrams.
- ❑ Time Exceeded: Time to live field in one of your packets became zero.” or “Reassembly timer expired at the destination.
- ❑ Fragmentation Required: Datagram was longer than MTU and “No Fragment bit” was set.
- ❑ Address Mask Request/Reply: What is the subnet mask on this net? Replied by “Address mask agent”
- ❑ PING uses ICMP echo
- ❑ Tracert uses TTL expired

Student Questions

Ref: Read Section 5.6 of the textbook and try erview questions R19-R20.

Washington University in St. Louis

<http://www.cse.wustl.edu/~jain/cse473-22/>

©2022 Raj Jain

Trace Route Example

```
C:\>tracert www.google.com
```

```
Tracing route to www.l.google.com [74.125.93.147]  
over a maximum of 30 hops:
```

```
 1  3 ms  1 ms  1 ms 192.168.0.1  
 2 12 ms 10 ms  9 ms bras4-10.stlsmo.sbcglobal.net [151.164.182.113]  
 3 10 ms  8 ms  8 ms dist2-vlan60.stlsmo.sbcglobal.net [151.164.14.163]  
 4  9 ms  7 ms  7 ms 151.164.93.224  
 5 25 ms 22 ms 22 ms 151.164.93.49  
 6 25 ms 22 ms 22 ms 151.164.251.226  
 7 30 ms 28 ms 28 ms 209.85.254.128  
 8 61 ms 57 ms 58 ms 72.14.236.26  
 9 54 ms 52 ms 51 ms 209.85.254.226  
10 79 ms 160 ms 67 ms 209.85.254.237  
11 66 ms 57 ms 68 ms 64.233.175.14  
12 60 ms 58 ms 58 ms qw-in-f147.google.com [74.125.93.147]
```

```
Trace complete.
```

Student Questions

Lab 5A: ICMP

- ❑ [14 points] Download the Wireshark traces from <http://gaia.cs.umass.edu/wireshark-labs/wireshark-traces.zip>
- ❑ Open *icmp-ethereal-trace-1* in Wireshark. Select **View → Expand All**. Answer the following questions:
 1. Examine Frame 3.
 - A. What is the IP address of your host? What is the IP address of the destination host?
 - B. Why is it that an ICMP packet does not have source and destination port numbers?
 - C. What are the ICMP type and code numbers? What other fields does this ICMP packet have? How many bytes are the checksum, sequence number and identifier fields?

Student Questions

Lab 5A (Cont)

2. Examine Frame 4. What are the ICMP type and code numbers?
 - ❑ Open *icmp-ethereal-trace-2* in Wireshark. Answer the following questions:
3. Examine Frame 2. What fields are included in this ICMP error packet?
4. Examine Frames 100, 101, and 102. How are these packets different from the ICMP error packet 2? Why are they not error packets?

Student Questions



Network Management

- ❑ What is Network Management?
- ❑ Components of Network Management
- ❑ How is Network Managed?
- ❑ SNMP protocol

Student Questions

What is Network Management?

- ❑ Traffic on Network = Data + Control + Management
- ❑ **Data** = Bytes/Messages sent by users
- ❑ **Control** = Bytes/messages added by the system to properly transfer the data (e.g., routing messages)
- ❑ **Management** = Optional messages to ensure that the network functions properly and to handle the issues arising from malfunction of any component
- ❑ If all components function properly, control is still required but management is optional.
- ❑ Examples:
 - Detecting failures of an interface card at a host or a router
 - Monitoring traffic to aid in resource deployment
 - Intrusion Detection

Student Questions

Components of Network Management

1. **Fault Management:**
Detect, log, and respond to fault conditions
 2. **Configuration Management:**
Track and control which devices are on or off
 3. **Accounting Management:**
Monitor resource usage for records and billing
 4. **Performance Management:**
Measure, report, analyze, and control traffic, messages
 5. **Security Management:**
Enforce policy for access control, authentication, and authorization
- ❑ **FCAPS**

Student Questions

How is Network Managed?

- ❑ Management = Initialization, Monitoring, Control
- ❑ Manager, Agents, and Management Information Base (MIB)

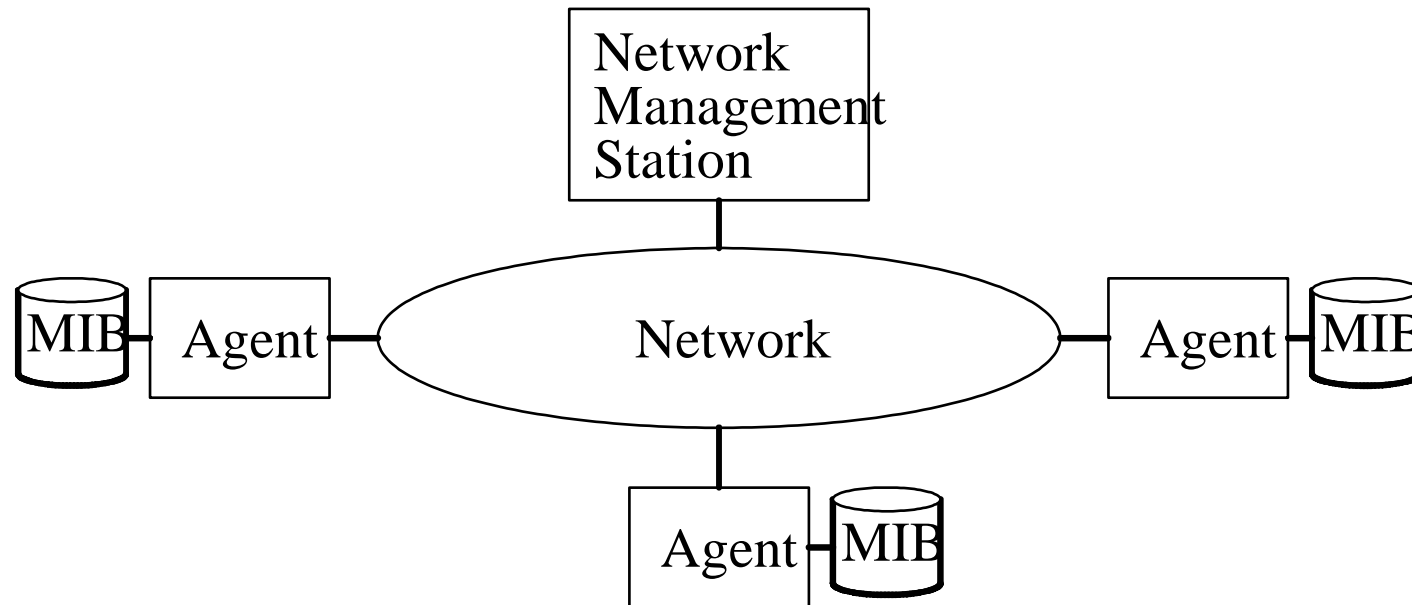

Student Questions

Example of Network Management

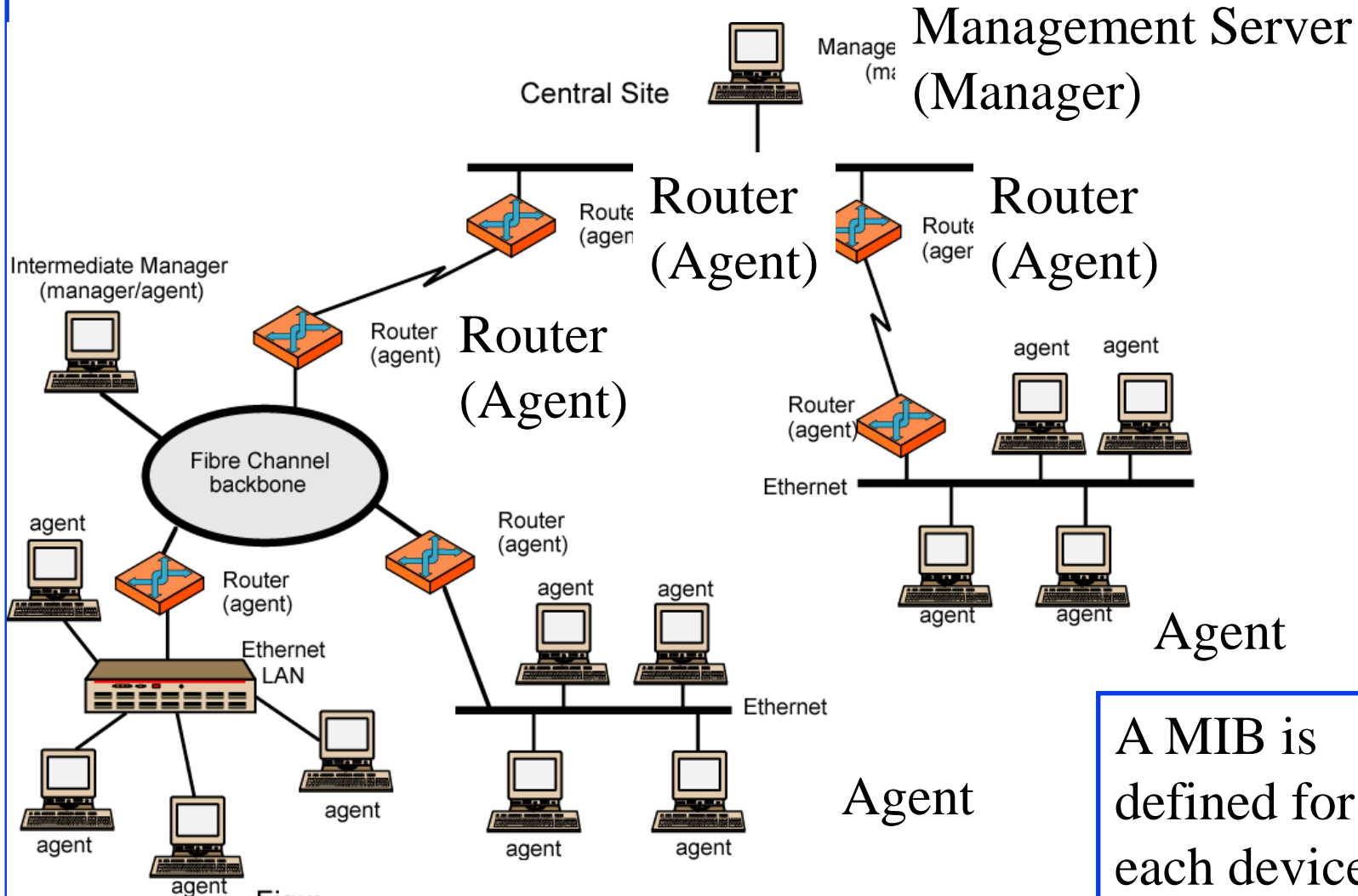

Figur

Student Questions

A MIB is defined for each device

SNMP

- ❑ Based on Simple Gateway Management Protocol (SGMP) – RFC 1028 – Nov 1987
- ❑ SNMP = **S**imply **N**ot **M**y **P**roblem [Marshall Rose]
Simple Network Management Protocol
- ❑ RFC 1058, April 1988
- ❑ Only Five commands

Command

Meaning

get-request

Fetch a value

get-next-request

Fetch the next value (in a tree)

get-response

Reply to a fetch operation

set-request

Store a value

trap

An event

Student Questions

SNMP protocol

Two ways to convey MIB info, commands:

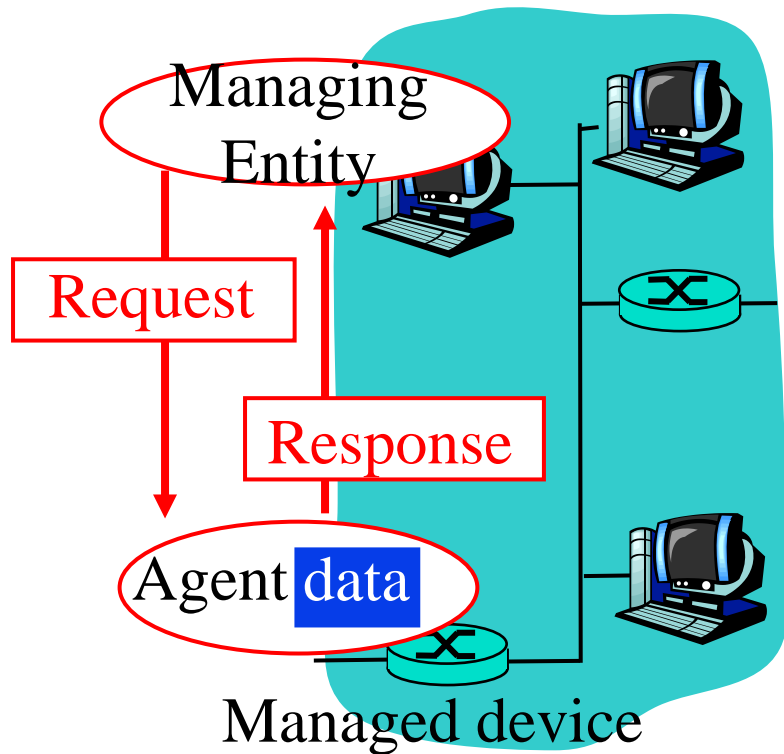

Request/response mode

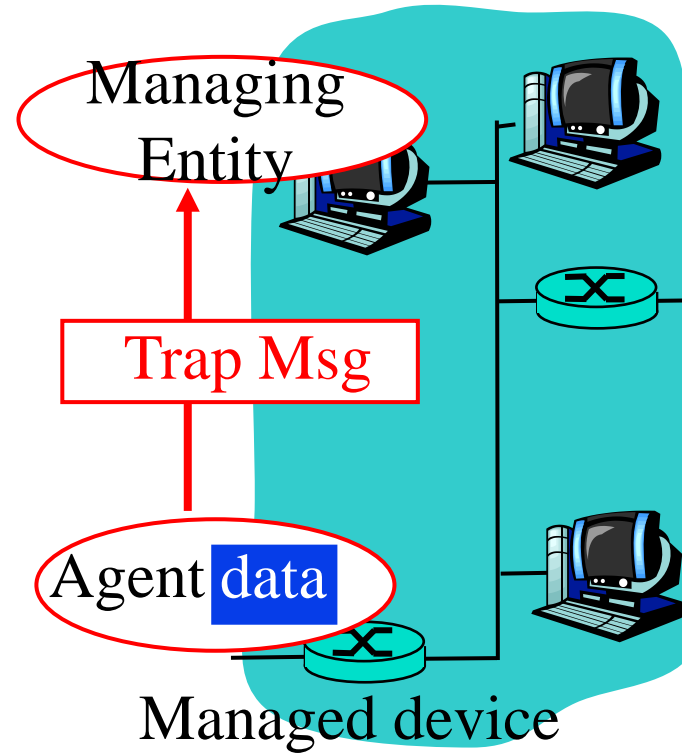

Trap mode

Student Questions

SNMP Message Formats

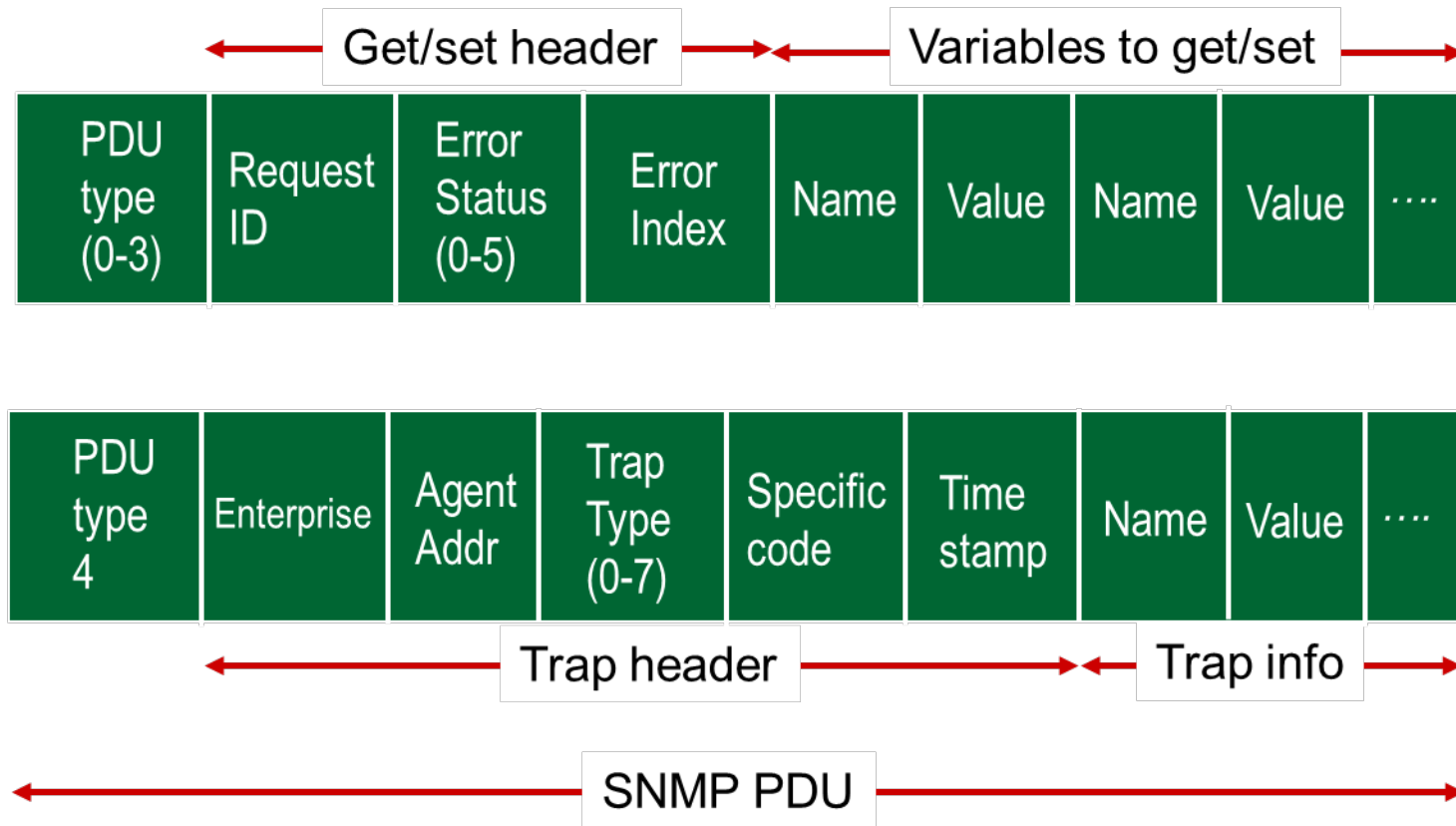

Student Questions

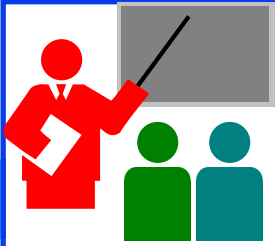

Network Management: Summary

1. Management = Initialization, Monitoring, and Control
2. Standard MIBs defined for each object
3. SNMP = Only 5 commands in the first version

Student Questions

Ref: Read Section 5.7 of the textbook and try review questions R21-R23.

Washington University in St. Louis

<http://www.cse.wustl.edu/~jain/cse473-22/>

©2022 Raj Jain

Network Layer Control Plane: Summary

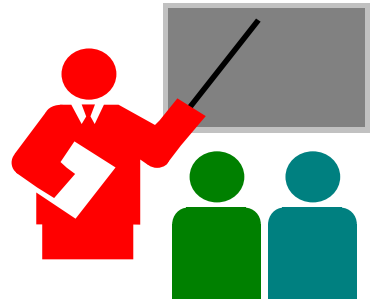

1. Dijkstra's algorithm allows path computation using link state
2. Bellman Ford's algorithm allows path computation using distance vectors.
3. OSPF is a link state IGP.
4. BGP is an EGP and uses path vectors
5. SDN controllers use various algorithms for centralized computation of path and other policies
6. ICMP is IP control protocol is used to convey errors
7. SNMP is the simple network management protocol to manage all devices and protocols in a network

Student Questions

Lab 5B: ICMP Ping Programming

[25 points] In this lab, you will gain a better understanding of Internet Control Message Protocol (ICMP). You will learn to implement a Ping application using ICMP request and reply messages.

Ping is a computer network application used to test whether a particular host is reachable across an IP network. It is also used to self-test the network interface card of the computer or as a latency test. It works by sending ICMP “echo reply” packets to the target host and listening for ICMP “echo reply” replies. The “echo reply” is sometimes called a pong. Ping measures the round-trip time, records packet loss, and prints a statistical summary of the echo reply packets received (the minimum, maximum, and the mean of the round-trip times and in some versions the standard deviation of the mean).

Your task is to develop your own Ping application in Python. Your application will use ICMP but, in order to keep it simple, will not exactly follow the official specification in RFC 1739. Note that you will only need to write the client side of the program, as the functionality needed on the server side is built into almost all operating systems.

You should complete the Ping application so that it sends ping requests to a specified host separated by approximately one second. Each message contains a payload of data that includes a timestamp. After sending each packet, the application waits up to one second to receive a reply. If one second goes by without a reply from the server, then the client assumes that either the ping packet or the pong packet was lost in the network (or that the server is down).

Student Questions

Lab 5B (Cont)

Code

Below you will find the skeleton code for the client. You are to complete the skeleton code. The places where you need to fill in code are marked with #Fill in start and #Fill in end. Each place may require one or more lines of code. This code was written for Python V2.7 and may not run on higher versions.

Additional Notes

In “receiveOnePing” method, you need to receive the structure ICMP_ECHO_REPLY and fetch the information you need, such as checksum, sequence number, time to live (TTL), etc. Study the “sendOnePing” method before trying to complete the “receiveOnePing” method.

You do not need to be concerned about the checksum, as it is already given in the code.

This lab requires the use of raw sockets. In some operating systems, you may need **administrator/root privileges** to be able to run your Pinger program.

Testing the Pinger

First, test your client by sending packets to localhost, that is, 127.0.0.1.

Then, you should see how your Pinger application communicates across the network by pinging servers in different continents.

What to Hand in

- ❑ You will hand in the complete client code and screenshots of your Pinger output for four target hosts: north-america.pool.ntp.org, europe.pool.ntp.org, asia.pool.ntp.org, south-america.pool.ntp.org

Student Questions

Lab 5B (Cont)

Skeleton Python Code for the ICMP Pinger

```
from socket import *
import os
import sys
import struct
import time
import select
import binascii
ICMP_ECHO_REQUEST = 8

def checksum(string):
    csum = 0
    countTo = (len(string) // 2) * 2
    count = 0
    while count < countTo:
        thisVal = ord(string[count+1]) * 256 + ord(string[count])
        csum = csum + thisVal
        csum = csum & 0xffffffff
        count = count + 2

    if countTo < len(string):
        csum = csum + ord(string[len(string) - 1])
        csum = csum & 0xffffffff

    csum = (csum >> 16) + (csum & 0xffff)
    csum = csum + (csum >> 16)
    answer = ~csum
    answer = answer & 0xffff
    answer = answer >> 8 | (answer << 8 & 0xff00)
    return answer
```

Student Questions

Lab 5B (Cont)

```
def receiveOnePing(mySocket, ID, timeout, destAddr):
    timeLeft = timeout
    while 1:
        startedSelect = time.time()
        whatReady = select.select([mySocket], [], [], timeLeft)
        howLongInSelect = (time.time() - startedSelect)
        if whatReady[0] == []: # Timeout
            return "Request timed out."
        timeReceived = time.time()
        recPacket, addr = mySocket.recvfrom(1024)
        #Fill in start
        #Fetch the ICMP header from the IP packet
        #Fill in end
        timeLeft = timeLeft - howLongInSelect
        if timeLeft <= 0:
            return "Request timed out."
```

Student Questions

Lab 5B (Cont)

```
def sendOnePing(mySocket, destAddr, ID):
    # Header is type (8), code (8), checksum (16), id (16), sequence (16)
    myChecksum = 0
    # Make a dummy header with a 0 checksum
    # struct -- Interpret strings as packed binary data
    header = struct.pack("bbHHh", ICMP_ECHO_REQUEST, 0, myChecksum, ID, 1)
    data = struct.pack("d", time.time())
    # Calculate the checksum on the data and the dummy header.
    myChecksum = checksum(str(header + data))

    # Get the right checksum, and put in the header
    if sys.platform == 'darwin':
        # Convert 16-bit integers from host to network byte order
        myChecksum = htons(myChecksum) & 0xffff
    else:
        myChecksum = htons(myChecksum)
    header = struct.pack("bbHHh", ICMP_ECHO_REQUEST, 0, myChecksum, ID, 1)
    packet = header + data

    mySocket.sendto(packet, (destAddr, 1)) # AF_INET address must be tuple, not str
    # Both LISTS and TUPLES consist of a number of objects
    # which can be referenced by their position number within the object.
```

Student Questions

Lab 5B (Cont)

```
def doOnePing(destAddr, timeout):
    icmp = getprotobyname("icmp")
    # SOCK_RAW is a powerful socket type. For more details: http://sock-raw.org/papers/sock\_raw
    mySocket = socket(AF_INET, SOCK_RAW, icmp)
    myID = os.getpid() & 0xFFFF # Return the current process i
    sendOnePing(mySocket, destAddr, myID)
    delay = receiveOnePing(mySocket, myID, timeout, destAddr)
    mySocket.close()
    return delay
```

```
def ping(host, timeout=1):
    # timeout=1 means: If one second goes by without a reply from the server,
    # the client assumes that either the client's ping or the server's pong is lost
    dest = gethostbyname(host)
    print("Pinging " + dest + " using Python:")
    print("")
    # Send ping requests to a server separated by approximately one second
    while 1 :
        delay = doOnePing(dest, timeout)
        print(delay)
        time.sleep(1)# one second
    return delay
```

Student Questions

Acronyms

- ❑ ABR Area border router
- ❑ API Application Programming Interface
- ❑ AS Autonomous System
- ❑ ASBR Autonomous System Boundary Router
- ❑ BDR Backup Designated Router
- ❑ BGP Border Gateway Protocol
- ❑ BR Backbone Router
- ❑ CAPWAP Control and Provisioning of Wireless Access Points
- ❑ CCITT Consultative Committee for International Telegraph and Telephone (now ITU-T)
- ❑ CoAP Constrained Application Protocol
- ❑ COPS Common Open Policy Service
- ❑ DIDM Device Identifier and Driver Management
- ❑ DLUX OpenDaylight User Interface
- ❑ DOCSIS Data over Cable Service Interface Specification
- ❑ DR Designated Router
- ❑ eBGP exterior BGP

Student Questions

Acronyms (Cont)

- ❑ EGP External Gateway Protocol
- ❑ ERP Exterior Router Protocol
- ❑ FCAPS Fault Configuration Accounting Performance and Security
- ❑ FRM Forwarding Rules Manager
- ❑ GBP Group Based Policy
- ❑ GUI Graphical User Interface
- ❑ HTTP Hyper-Text Transfer Protocol
- ❑ iBGP interior BGP
- ❑ ICMP IP Control Message Protocol
- ❑ ID Identifier
- ❑ IDRP ICMP Router Discovery Protocol
- ❑ IGP Interior Gateway Protocol
- ❑ IGRP Interior Gateway Routing Protocol
- ❑ IP Internet Protocol
- ❑ IRP Interior Router Protocol
- ❑ ISO International Standards Organization

Student Questions

Acronyms (Cont)

- ❑ LACP Link Aggregation Control Protocol
- ❑ LSA Link State Advertisements
- ❑ MIB Management Information Base
- ❑ MTU Maximum Transmission Unit
- ❑ NETCONF Network Configuration Protocol
- ❑ NIC Network Interface Card
- ❑ OSGi Open Service Gateway Initiative
- ❑ OSI Open Service Interconnection
- ❑ OSPF Open Shortest Path First
- ❑ OVSDB Open Vswitch Database
- ❑ PCEP Path Computation Element Protocol
- ❑ PCMM Packet Cable Multimedia
- ❑ REST Representational State Transfer
- ❑ RESTful Representational State Transfer
- ❑ RFC Request for Comments
- ❑ SAL Service Abstraction Layer

Student Questions

Acronyms (Cont)

- ❑ SDN Software Defined Networking
- ❑ SDNI SDN domains interface
- ❑ SFC Service Function Chaining
- ❑ SGMP Simple Gateway Management Protocol
- ❑ SNBI Secure Network Bootstrapping Interface
- ❑ SNMP Simple Network Management Protocol
- ❑ SXP SGT (Security Group Tags) Exchange Protocol
- ❑ TCP Transmission Control Protocol
- ❑ ToS Type of Service
- ❑ TSDR Time Series Data Repository
- ❑ TTL Time to Live
- ❑ UDP User Datagram Protocol
- ❑ USC Unified Secure Channel
- ❑ VPN Virtual Private Network
- ❑ VTN Virtual Tenant Network

Student Questions

Scan This to Download These Slides



Raj Jain

<http://rajjain.com>

http://www.cse.wustl.edu/~jain/cse473-22/i_5n1c.htm

Student Questions

- ❖ Can you explain how collisions are avoided by randomizing the execution of LS algorithms at each node and only running it at one node at a single time?

Collision avoidance usually requires someone to wait a random amount of time. However, clocks at different nodes are not synchronized, so they are already random.

Related Modules



CSE 567: The Art of Computer Systems Performance Analysis
https://www.youtube.com/playlist?list=PLjGG94etKypJEKjNAa1n_1X0bWWNyZcof

CSE473S: Introduction to Computer Networks (Fall 2011),

https://www.youtube.com/playlist?list=PLjGG94etKypJWOSPMh8Azcg5e_10TiDw



CSE 570: Recent Advances in Networking (Spring 2013)

<https://www.youtube.com/playlist?list=PLjGG94etKypLHyBN8mOgwJLHD2FFIMGq5>

CSE571S: Network Security (Spring 2011),

<https://www.youtube.com/playlist?list=PLjGG94etKypKvzfVtutHcPFJXumyyg93u>



Video Podcasts of Prof. Raj Jain's Lectures,
<https://www.youtube.com/channel/UCN4-5wzNP9-ruOzQMs-8NUw>

Student Questions