

# Wireless Protocols for IoT Part I: Bluetooth and Bluetooth Smart



Raj Jain

Professor of CSE

Washington University in Saint Louis

Saint Louis, MO 63130

Jain@cse.wustl.edu

Audio/Video recordings of this class lecture are available on-line at:

<http://www.cse.wustl.edu/~jain/cse574-20/>

Student Questions



1. Bluetooth: Packet Format, Energy Management
2. Bluetooth Protocol Stack, Application Profiles
3. Bluetooth LE: Protocol Stack, PHY, MAC
4. Bluetooth and Wi-Fi Coexistence

Note: This is one in a series of lectures on WPANs. ZigBee and other networks are discussed in subsequent lectures.

## Student Questions



# Bluetooth

- ❑ Started with Ericsson's Bluetooth Project in 1994 for radio-communication between cell phones over short distances
- ❑ Named after Danish king Herald Blatand (AD 940-981) who was fond of blueberries
- ❑ Intel, IBM, Nokia, Toshiba, and Ericsson formed Bluetooth SIG in May 1998
- ❑ Version 1.0A of the specification came out in late 1999.
- ❑ IEEE 802.15.1 approved in early 2002 is based on Bluetooth  
Later versions handled by Bluetooth SIG directly
- ❑ Key Features:
  - Lower Power: 10 mA in standby, 50 mA while transmitting
  - Cheap: \$5 per device
  - Small: 9 mm<sup>2</sup> single chips

## Student Questions



# Bluetooth Versions

- ❑ **Bluetooth 1.1:** IEEE 802.15.1-2002
- ❑ **Bluetooth 1.2:** IEEE 802.15.1-2005. Completed Nov 2003. Extended SCO, Higher variable rate retransmission for SCO + Adaptive frequency hopping (avoid frequencies with interference).
- ❑ **Bluetooth 2.0** + Enhanced Data Rate (EDR) (Nov 2004): 3 Mbps using DPSK. For video applications. Reduced power due to reduced duty cycle
- ❑ **Bluetooth 2.1** + EDR (July 2007): Secure Simple Pairing to speed up pairing
- ❑ **Bluetooth 3.0+** High Speed (HS) (April 2009): 24 Mbps using WIFI PHY + Bluetooth PHY for lower rates
- ❑ **Bluetooth 4.0** (June 2010): Low energy. Smaller devices requiring longer battery life (several years). New incompatible PHY. Bluetooth Smart or BLE
- ❑ **Bluetooth 4.1:** 4.0 + Core Specification Amendments (CSA) 1, 2, 3, 4
- ❑ **Bluetooth 4.2** (Dec 2014): Larger packets, security/privacy, IPv6 profile

Ref: ITL, "Security of Bluetooth Systems and Devices," [http://csrc.nist.gov/publications/nistbul/august-2012\\_itl-bulletin.pdf](http://csrc.nist.gov/publications/nistbul/august-2012_itl-bulletin.pdf)

## Student Questions

# Bluetooth 5

- ❑ June/December 2016
- ❑ Enhanced Bluetooth low energy
- ❑ Supports many more devices at low energy, e.g., headphones,
- ❑ Dual-audio: two headphones playing two streams
- ❑ 2X Data rate using a new modulation  $\Rightarrow$  2 Mbps

Or 4X range 800 ft using a special coding (Good for beacons)

Long-Range mode allows 1.6 km at 125 kbps

- ❑ 8X broadcast capacity by changing the advertising procedure. 255B instead of 31B with v4.2
- ❑ aptX compression allows CD quality audio over 1 Mbps. Bluetooth 5.0 allows better quality using 2 Mbps.
- ❑ +20 dBm transmit power in LE mode  $\Rightarrow$  Good for bursts
- ❑ Both ends must be Bluetooth 5 to benefit.  
Backward compatible with older devices using older modes

Ref: Madhur Bhargava, "IoT Projects with Bluetooth Low Energy," Packt Publishing, August 2017, 278 pp., ISBN:978-1-78839-683-7 (Safari Book).

## Student Questions

# Bluetooth: Details

- ❑ **Frequency Range:** 2402 - 2480 MHz  
(total 79 MHz band) 23 MHz in some countries, e.g., Spain
- ❑ **Data Rate:** 1 Mbps using 1 MHz (Nominal) 720 kbps (User)
- ❑ **Radio Frequency hopping:** 1600 times/s  $\Rightarrow$  625  $\mu$ s/hop
- ❑ **Security:** Challenge/Response Authentication. 128b Encryption
- ❑ **TX Output Power:**
  - Class 1: 20 dBm Max. (0.1W) – 100m
  - Class 2: 4 dBm (2.5 mW)
  - **Class 3:** 0 dBm (1mW) – 10m

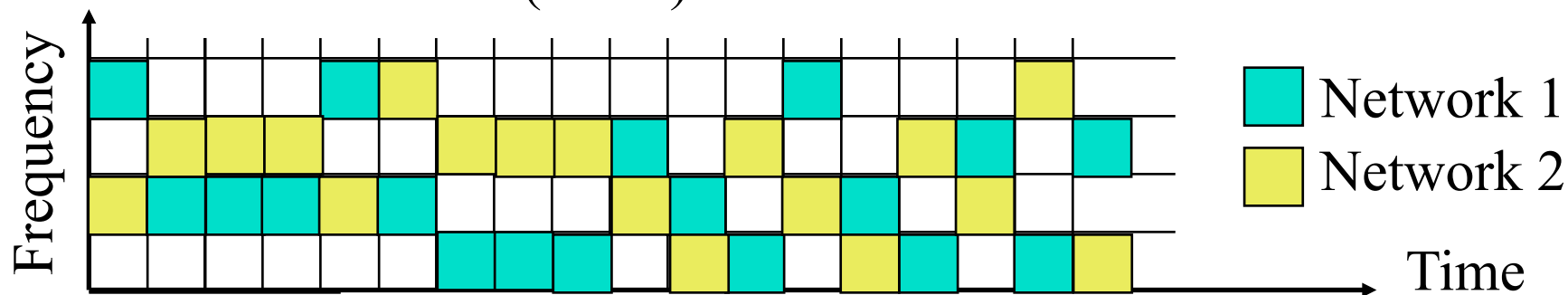

Ref: <http://www.bluetooth.com/>, <http://www.bluetooth.org/>, <http://grouper.ieee.org/groups/802/15/index.html>

## Student Questions

# Piconet

- ❑ Piconet is formed by a master and many slaves
  - Up to 7 active slaves.  
Slaves can only transmit when requested by master
  - Up to 255 Parked slaves
- ❑ Active slaves are polled by master for transmission
- ❑ Each station gets a 8-bit parked address  
⇒ 255 parked slaves/piconet
- ❑ The parked station can join in 2us.
- ❑ Other stations can join in more time.
- ❑ **Scatter net**: A device can participate in multiple Pico nets ⇒ Timeshare and must synchronize to the master of the current piconet.

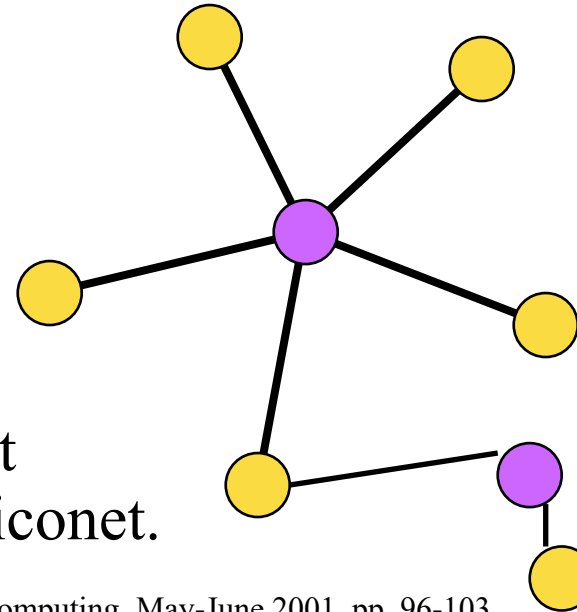

## Student Questions

Ref: P. Bhagwat, "Bluetooth Technology for short range wireless Apps," IEEE Internet Computing, May-June 2001, pp. 96-103,  
[bluetooth.pdf \(Must read\)](#)

# Frequency Hopping Sequences

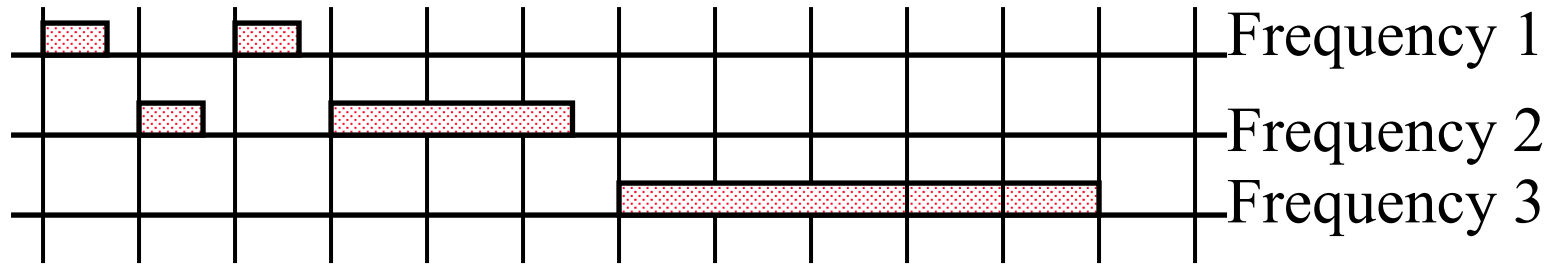

- ❑ 625  $\mu$ s slots using a 312.5  $\mu$ s clock
- ❑ Time-division duplex (TDD)  
⇒ Downstream and upstream alternate
- ❑ Master starts in even numbered slots only.
- ❑ Slaves start in odd numbered slots only
- ❑ Slaves can transmit in one slot right after receiving a packet from master
- ❑ Packets = 1 slot, 3 slot, or 5 slots long
- ❑ The frequency hop is skipped during a packet.

## Student Questions



# Bluetooth Packet Format

Access Code	Baseband/Link Control Header	Data Payload
72b	54b	0-2745b

- ❑ Packets can be up to five slots long. 5 slots = 3125 bits.
- ❑ Access codes:
  - Channel access code identifies the piconet
  - Device access code for paging requests and response
  - Inquiry access code to discover units
- ❑ Header: member address (3b), type code (4b), flow control, ack/nack (1b), sequence number, and header error check (8b)  
18b Header is encoded using 1/3 rate FEC resulting in 54b
- ❑ Synchronous traffic has periodic reserved slots.
- ❑ Other slots can be allocated for asynchronous traffic

## Student Questions

# Bluetooth Operational States

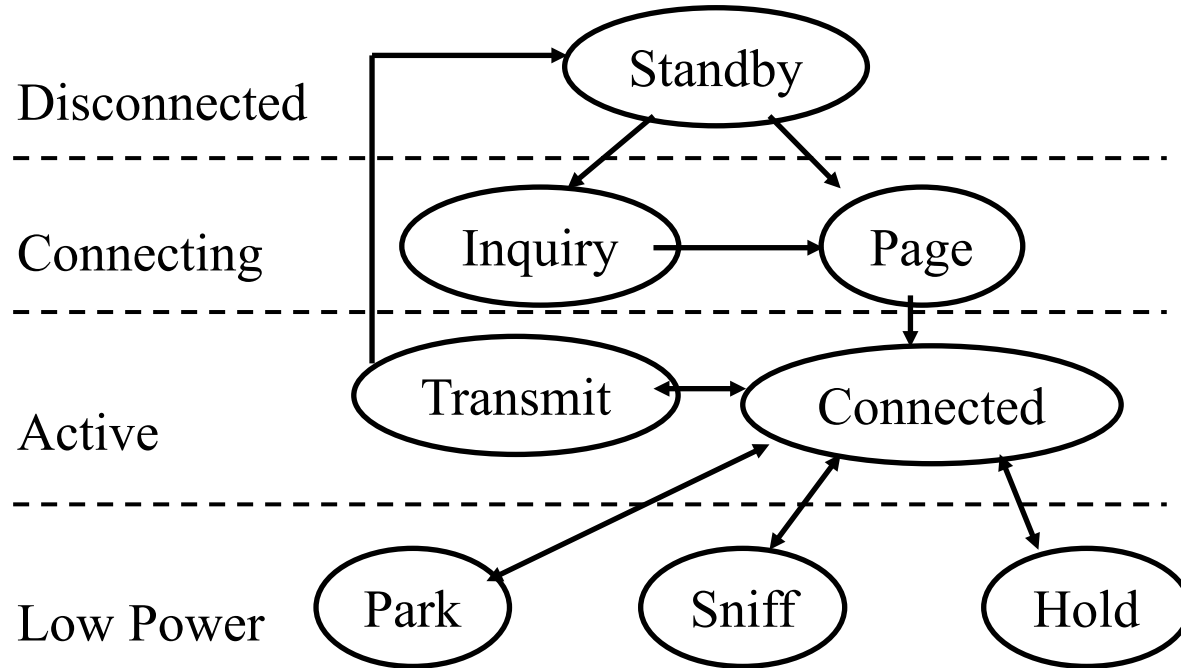

- ❑ **Standby:** Initial state
- ❑ **Inquiry:** Master sends an inquiry packet. Slaves scan for inquiries and respond with their address and clock after a random delay (CSMA/CA)

## Student Questions

# Bluetooth Operational States (Cont)

- ❑ **Page:** Master in page state invites devices to join the piconet. Page message is sent in 3 consecutive slots (3 frequencies). Slave enters page response state and sends page response including its device access code.
- ❑ Master informs slave about its clock and address so that slave can participate in piconet. Slave computes the clock offset.
- ❑ **Connected:** A short 3-bit logical address is assigned
- ❑ **Transmit:**

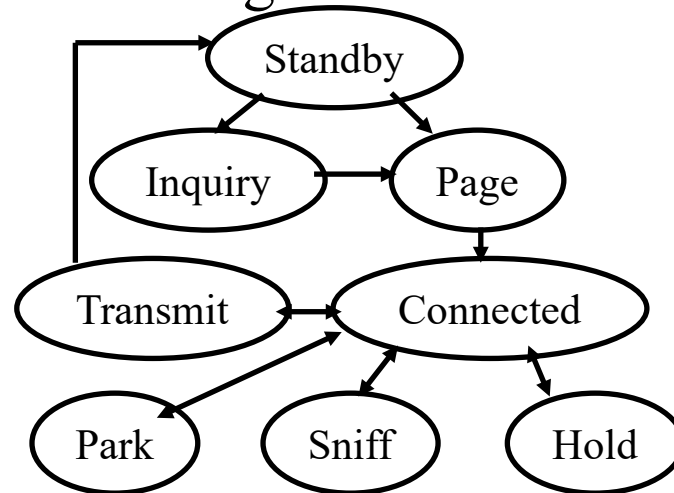

## Student Questions

# Energy Management in Bluetooth

Three inactive states:

1. **Hold**: No Asynchronous Connection List (ACL). Synchronous Connection Oriented (SCO) continues.  
Node can do something else: scan, page, inquire
2. **Sniff**: Low-power mode. Slave listens after fixed sniff intervals.
3. **Park**: Very Low-power mode. Gives up its 3-bit active member address and gets an 8-bit parked member address. Wake up periodically and listen to beacons. Master broadcasts a train of beacons periodically

Sniff

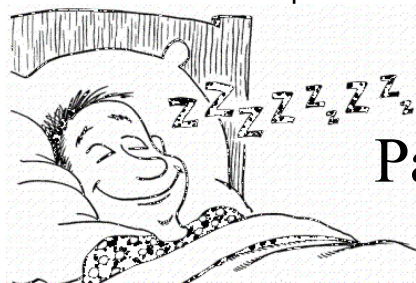
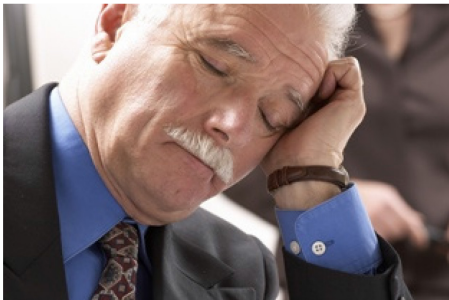

Park

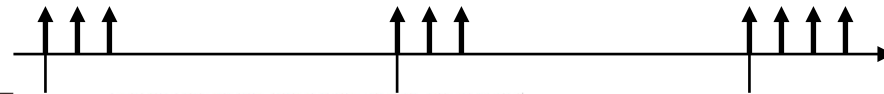

## Student Questions

# Bluetooth Protocol Stack

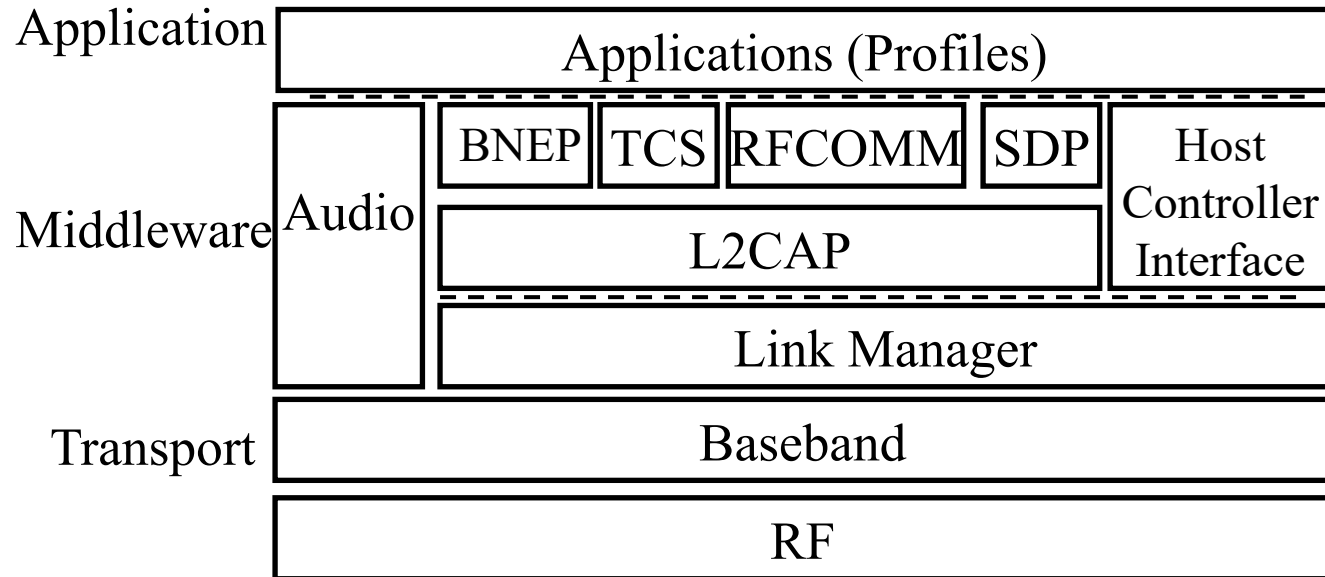

- ❑ **RF:** Frequency hopping Gaussian Frequency Shift Keying (GFSK) modulation
- ❑ **Baseband:** Frequency hop selection, connection, MAC

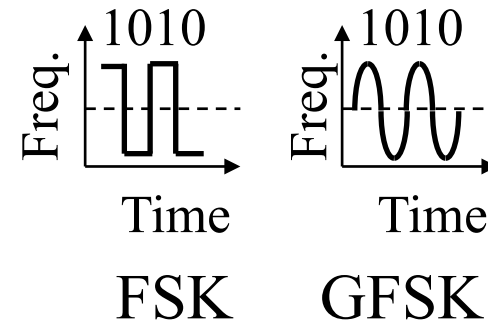

## Student Questions

# Baseband Layer

- ❑ Each device has a 48-bit IEEE MAC address
- ❑ 3 parts:
  - Lower address part (LAP) – 24 bits
  - Upper address part (UAP) – 8 bits
  - Non-significant address part (NAP) - 16 bits
- ❑ UAP+NAP = Organizationally Unique Identifier (OUI) from IEEE
- ❑ LAP is used in identifying the piconet and other operations
- ❑ Clock runs at 3200 cycles/sec or 312.5  $\mu$ s (twice the hop rate)

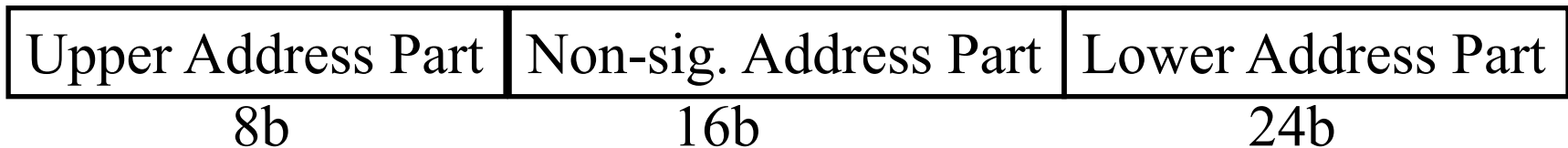

## Student Questions

# Bluetooth Protocol Stack (Cont)

- ❑ **Link Manager:** Negotiate parameters, Set up connections
- ❑ **Logical Link Control and Adaptation Protocol (L2CAP):**
  - Protocol multiplexing
  - Segmentation and reassembly
  - Controls peak bandwidth, latency, and delay variation
- ❑ Host **Controller Interface:** Chip independent interface to Bluetooth chip. Allows same software to run on all chips.
- ❑ **RFCOMM Layer:** Presents a virtual serial port
  - Sets up a connection to another RFCOMM
- ❑ **Service Discovery Protocol (SDP):** Devices can discover the services offered and their parameters

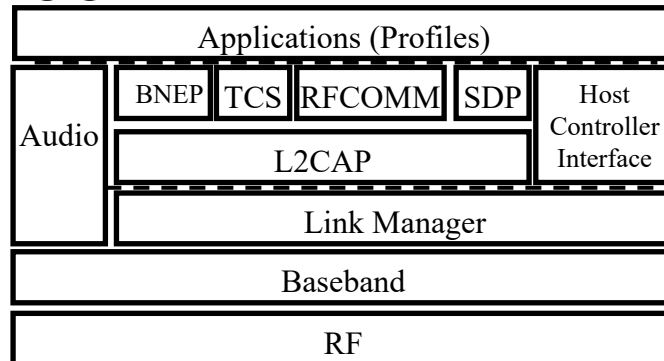

## Student Questions

# Bluetooth Protocol Stack (Cont)

- ❑ **Bluetooth Network Encapsulation Protocol (BNEP):** To transport Ethernet/IP packets over Bluetooth
- ❑ **IrDA Interoperability protocols:** Allow existing IrDA applications to work w/o changes. IrDA object Exchange (IrOBEX) and Infrared Mobile Communication (IrMC) for synchronization
- ❑ **Audio** is carried over 64 kbps over SCO links over baseband
- ❑ **Telephony control specification binary (TCS-BIN):** Call control including group management (multiple extensions, call forwarding, and group calls)
- ❑ **Application Profiles:** Set of algorithms, options, and parameters.

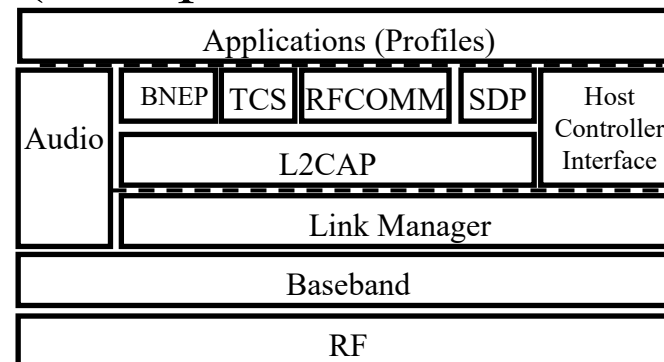

## Student Questions



# Application Profile Examples

- ❑ Headset Profile
- ❑ Global Navigation Satellite System Profile
- ❑ Hands-Free Profile
- ❑ Phone Book Access Profile
- ❑ SIM Access Profile
- ❑ Synchronization Profile
- ❑ Video Distribution Profile
- ❑ Blood Pressure Profile
- ❑ Cycling Power Profile
- ❑ Find Me Profile
- ❑ Heart Rate Profile
- ❑ Basic Printing Profile
- ❑ Dial-Up Networking Profile
- ❑ File Transfer Profile

Ref: Bluetooth SIG, “Adopted Bluetooth Profiles, Services, Protocols and Transports,”

<https://www.bluetooth.org/en-us/specification/adopted-specifications>

## Student Questions



## Bluetooth Smart

- ❑ **Low Energy:** 1% to 50% of Bluetooth classic
- ❑ **For short broadcast:** Your body temperature, Heart rate, Wearables, **sensors**, automotive, industrial.  
Not for voice/video, file transfers, ...
- ❑ **Small messages:** 1Mbps data rate but throughput not critical.
- ❑ **Battery life:** In years from coin cells
- ❑ **Simple:** Star topology. No scatter nets, mesh, ...
- ❑ **Lower cost** than Bluetooth classic
- ❑ **New** protocol design based on Nokia's **WiBree** technology  
Shares the same 2.4GHz radio as Bluetooth  
⇒ Dual mode chips
- ❑ All new smart phones (iPhone, Android, ...) have dual-mode chips

### Student Questions

# Bluetooth Smart PHY

- ❑ 2.4 GHz. 150 m open field
- ❑ Star topology
- ❑ 1 Mbps Gaussian Frequency Shift Keying  
Better range than Bluetooth classic
- ❑ Adaptive Frequency hopping. 40 Channels with 2 MHz spacing.
- ❑ 3 channels reserved for **advertising** and 37 channels for data
- ❑ Advertising channels specially selected to avoid interference with Wi-Fi channels

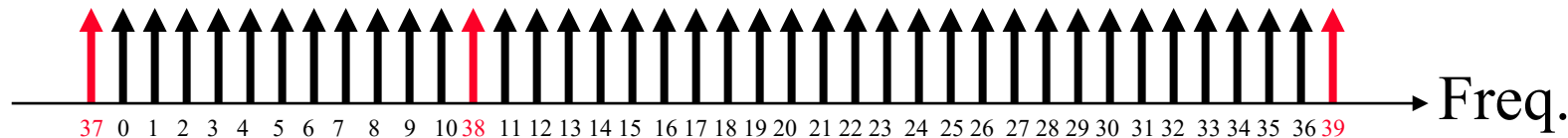
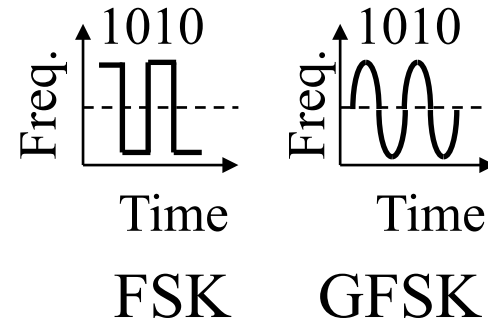

Ref: J. Decuir, "Bluetooth 4.0: Low Energy," 2010,

<https://californiaconsultants.org/wp-content/uploads/2014/05/CNSV-1205-Decuir.pdf>

Washington University in St. Louis

<http://www.cse.wustl.edu/~jain/cse574-20/>

©2020 Raj Jain

## Student Questions

# Bluetooth Smart MAC

- ❑ Two Device Types: “**Peripherals**” simpler than “**central**”
- ❑ Two PDU Types: Advertising, Data
- ❑ **Non-Connectable Advertising**: Broadcast data in clear
- ❑ **Discoverable Advertising**: Central may request more information. Peripheral can send data without connection
- ❑ **General Advertising**: Broadcast presence wanting to connect. Central may request a short connection.
- ❑ **Directed Advertising**: Transmit signed data to a previously connected master

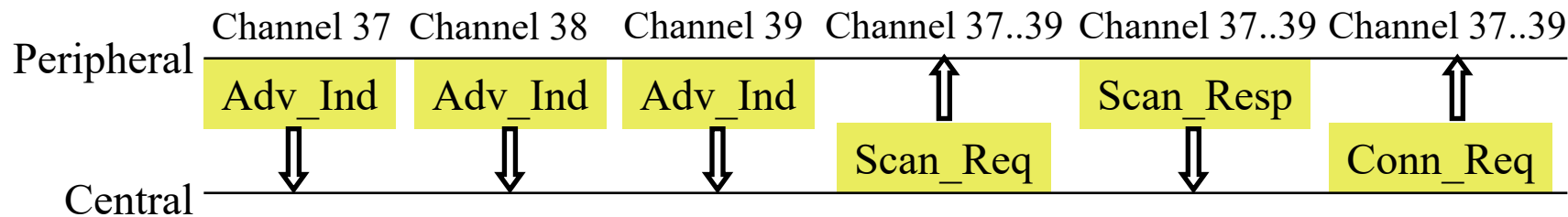

Ref: J. Decuir, “Bluetooth 4.0: Low Energy,” 2010,

<https://californiaconsultants.org/wp-content/uploads/2014/05/CNSV-1205-Decuir.pdf>

## Student Questions

# Bluetooth Smart MAC (Cont)

- ❑ After connecting, master tells slave about hopping sequence and wake up cycle
- ❑ All subsequent data transfers in 37 data channels
- ❑ Both devices can sleep between transactions
- ❑ Data can be encrypted.
- ❑ ~3 ms per transaction, 15 mW Power = 10 mA using 1.5V
  - ⇒ 30mAs/transaction
  - ⇒ 21.6 M transactions using 180 mAh battery
  - ⇒ 41.1 years with 1 transaction/minute

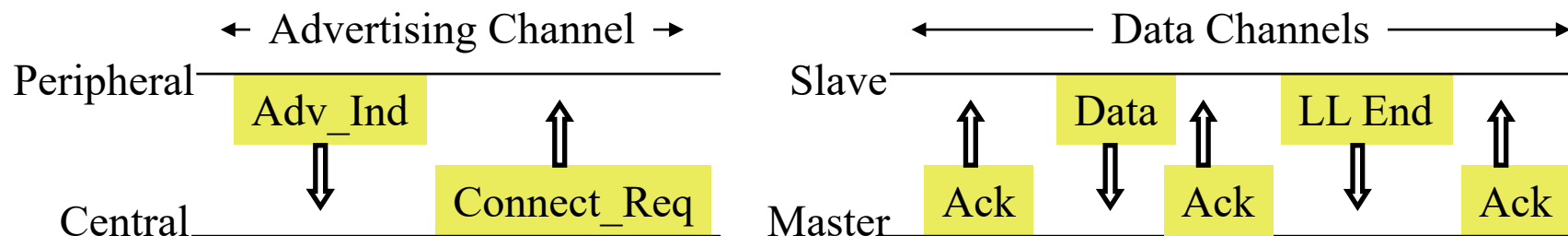

## Student Questions

# Bluetooth Smart Protocol Stack

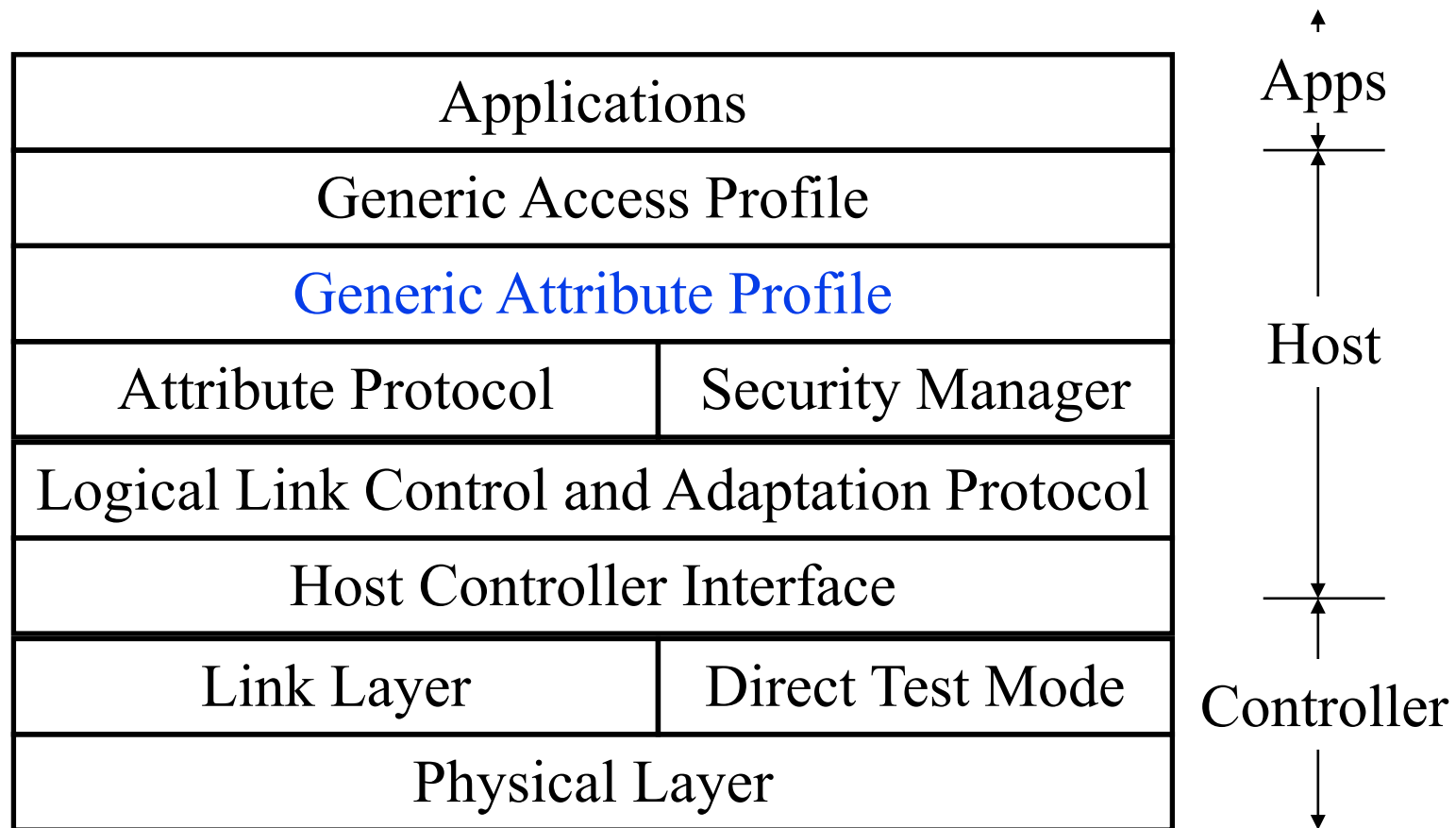

## Student Questions

Ref: J. Decuir, "Bluetooth 4.0: Low Energy," 2010,

<https://californiaconsultants.org/wp-content/uploads/2014/05/CNSV-1205-Decuir.pdf>

Washington University in St. Louis

<http://www.cse.wustl.edu/~jain/cse574-20/>

©2020 Raj Jain

# Generic Attribute (GATT) Profile

- ❑ Defines data formats and interfaces with the Attribute Protocol
- ❑ Type-Length-Value (TLV) encoding is used
- ❑ Each attribute has a 16-bit Universally Unique ID (UUID) standardized by Bluetooth SIG
- ❑ 128-bit UUID if assigned by a manufacturer
- ❑ Allows any client to find a server, read/write data  
Allows servers to talk to generic gateways
- ❑ Allows security up to AES-128
- ❑ Each to encode in XML
- ❑ Makes profile (application) development easier

## Student Questions

# Bluetooth Gateway Devices

- ❑ A gateway device helps connect a Bluetooth device to the Internet. Smart phone, Tablets, PC, ...
- ❑ A generic app can forward the data to the URL sent by the device

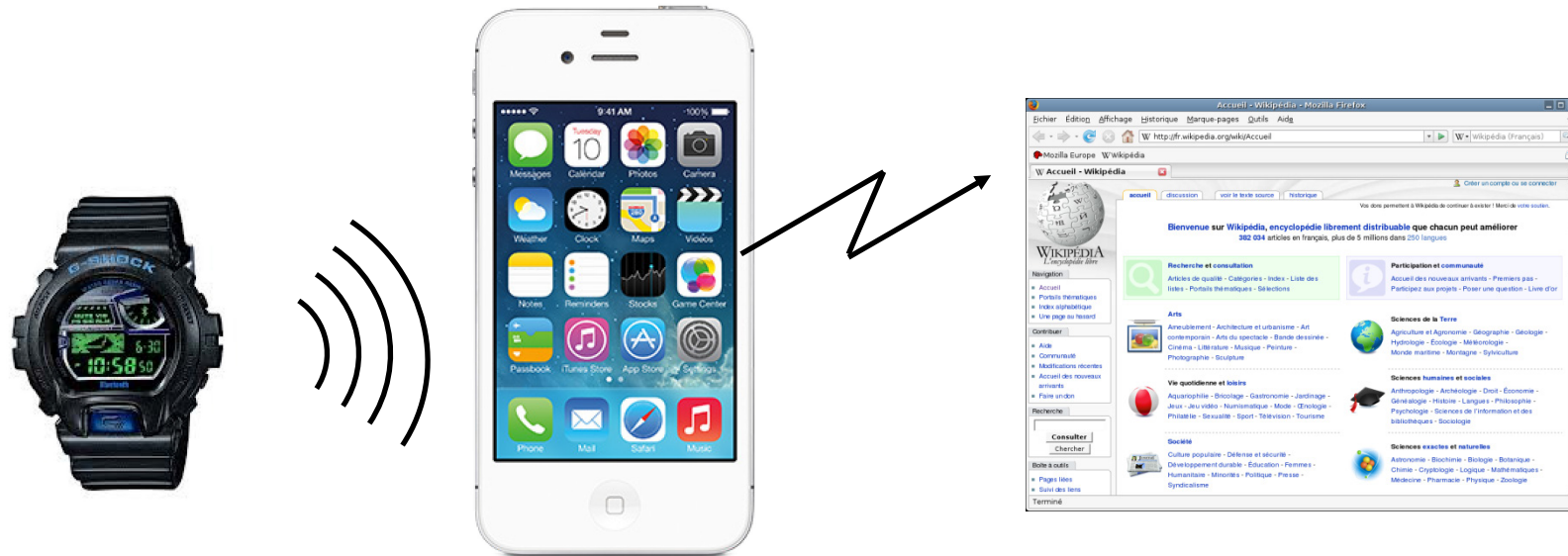

## Student Questions



# Bluetooth Smart Applications

- ❑ Proximity: In car, In room 303, In the mall
- ❑ Locator: Keys, watches, Animals
- ❑ Health devices: Heart rate monitor, physical activities monitors, thermometer
- ❑ Sensors: Temperature, Battery Status, tire pressure
- ❑ Remote control: Open/close locks, turn on lights

## Student Questions

Ref: E. Vlugt, "Bluetooth Low Energy, Beacons and Retail," Verifone White paper, 2013, 12 pp.,

<https://www.slideshare.net/verifone/bluetooth-low-energy-beacons-and-retail-final>



# Beacons

- ❑ Advertising based on proximity
- ❑ Peripherals (your phone) broadcasts its presence if Bluetooth is turned on
- ❑ Primary aim of these broadcasts is to allow device discovery and indoor navigation
- ❑ Advertising packets consist of a header and max 27B of payload with multiple TLV-encoded data items
  - May include signal strength  $\Rightarrow$  Distance
- ❑ iOS7 iPhones can send/received iBeacons
- ❑ Can be used for customized advertising, indoor location, geofencing
- ❑ PayPal uses this to identify you.  
You can pay using a PIN and your phone.
- ❑ Google is promoting Eddystone beacons which requires only a browser (not another app) to discover proximity using beacons



## Student Questions

# Summary

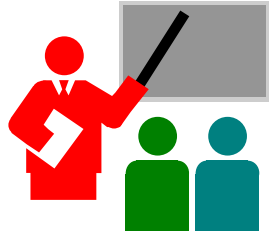

1. Bluetooth basic rate uses frequency hopping over 79 1-MHz channels with 1, 3, 5 slots packets.
2. Three inactive states: hold, sniff, park. Has a fixed set of applications called "Profiles"
3. Bluetooth and WIFI co-exist by time-sharing or adaptive frequency notching
4. Bluetooth Smart is designed for short broadcasts by sensors. 40 2-MHz channels with 3 channels reserved for advertising. One or two-message exchanges
5. Generic attribute profile allows new applications using UUID for data types

## Student Questions

# Homework 11

- Submit answer to the following Problem:  
Assume that in one slot in Bluetooth 256 bits of payload could be transmitted. How many slots are needed if the payload size is (a) 512 bits, (b) 728 bits, and (c) 1024 bits. Assume that the non-payload portions do not change.

## Student Questions

# Reading List: Bluetooth

- ❑ Madhur Bhargava, "IoT Projects with Bluetooth Low Energy," Packt Publishing, August 2017, 278 pp., ISBN:978-1-78839-683-7 (Safari Book).
- ❑ Kevin Townsend, Carles Cufí, Akiba, Robert Davidson, "Getting Started with Bluetooth Low Energy," O'Reilly Media, Inc., May 2014, 180 pp., ISBN:978-1-4919-4951-1 (Safari Book), Chapter 2.
- ❑ J. Decuir, "Bluetooth 4.0: Low Energy," 2010, 62 pp., <https://californiaconsultants.org/wp-content/uploads/2014/05/CNSV-1205-Decuir.pdf>
- ❑ E. Vlught, "Bluetooth Low Energy, Beacons and Retail," Verifone White paper, 2013, 12 pp., <https://www.slideshare.net/verifone/bluetooth-low-energy-beacons-and-retail-final>
- ❑ P. Bhagwat, "Bluetooth Technology for short range wireless Apps," IEEE Internet Computing, May-June 2001, pp. 96-103, <http://ieeexplore.ieee.org/xpl/abstractKeywords.jsp?arnumber=935183>

## Student Questions

# References

- ❑ Bluetooth SIG, <http://www.bluetooth.com/lowenergy>
- ❑ Bluetooth SIG, "BLUETOOTH 4.1 Features and Technical Description," 2013, <https://www.bluetooth.org/en-us/Documents/Bluetooth%204.1%20Technical%20Description.pdf>
- ❑ Bluetooth SIG, "Adopted Bluetooth Profiles, Services, Protocols and Transports," <https://www.bluetooth.org/en-us/specification/adopted-specifications>
- ❑ <http://whatis.techtarget.com/definition/Bluetooth-20EDR>
- ❑ ITL, "Security of Bluetooth Systems and Devices," [http://csrc.nist.gov/publications/nistbul/august-2012\\_itl-bulletin.pdf](http://csrc.nist.gov/publications/nistbul/august-2012_itl-bulletin.pdf)
- ❑ E. Ferro and F. Potorti, "'Bluetooth and Wi-Fi wireless protocols: a survey and a comparison", Volume: 12 Issue: 1, Pages: 12-26, IEEE Wireless Communications, 2005, <http://ieeexplore.ieee.org/iel5/7742/30466/01404569.pdf?tp=&arnumber=1404569&isnumber=30466>

## Student Questions

## References (Cont)

- ❑ P. McDermott-Wells, "What is Bluetooth?", Volume 23, Issue 5, Page(s):33 - 35, IEEE Potentials, 2005,  
<http://ieeexplore.ieee.org/iel5/45/29958/01368913.pdf?tp=&arnumber=1368913&isnumber=29958>
- ❑ K.V.S.S.S.S. Sairam, N. Gunasekaran, and S.R. Redd, "Bluetooth in wireless communication" Volume 40, Issue 6, Page(s):90 - 96, IEEE Communications Magazine, June 2002,  
<http://ieeexplore.ieee.org/iel5/35/21727/01007414.pdf?tp=&arnumber=1007414&isnumber=21727>
- ❑ B. Chatschik, "An overview of the Bluetooth wireless technology", Volume 39, Issue 12, Page(s):86 - 94, IEEE Communications Magazine, 2001,  
<http://ieeexplore.ieee.org/iel5/35/20896/00968817.pdf?tp=&arnumber=968817&isnumber=20896>

## Student Questions

# Acronyms

- ❑ ACL Asynchronous Connection List
- ❑ AD Anno Domini (Latin for *in the year of the Lord*)
- ❑ AES-128 Advanced Encryption Standard w 128 bit keys
- ❑ BIN Binary
- ❑ BLE Bluetooth Low Energy
- ❑ BNEP Bluetooth Network Encapsulation Protocol
- ❑ CAP Connection Access Profile
- ❑ CSA Core Specification Amendment
- ❑ dBm Deci-bel milli-watt
- ❑ DPSK Differential Phase Shift Keying
- ❑ EDR Enhanced Data Rate,
- ❑ FEC Forward Error Correction
- ❑ FSK Frequency Shift Keying
- ❑ GATT Generic Attribute
- ❑ GFSK Gaussian Frequency Shift Keying
- ❑ GHz Giga Hertz
- ❑ HS High Speed,

## Student Questions



# Acronyms (Cont)

- ❑ IBM International Business Machines
- ❑ ID Identifier
- ❑ IEEE Institution of Electrical and Electronics Engineers
- ❑ iOS Apple's idevices Operating System
- ❑ IoT Internet of Things
- ❑ IP Internet Protocol
- ❑ IPv6 Internet Protocol version 6
- ❑ IrDA Infrared Data Association
- ❑ IrMC Infrared Mobile Communications
- ❑ IrOBEX Infrared Object Exchange
- ❑ LAN Local Area Network
- ❑ LAP Lower address part
- ❑ LE Low Energy
- ❑ LL Logical Link
- ❑ MAC Media Access Control
- ❑ MAN Metropolitan Area Network

## Student Questions

# Acronyms (Cont)

- ❑ MHz Mega Hertz
- ❑ mW milli Watt
- ❑ NAP Non-significant address part
- ❑ OUI Organizationally Unique Identifier
- ❑ PAL Protocol Adaptation Layer
- ❑ PC Personal Computer
- ❑ PDU Protocol Data Unity
- ❑ PHY Physical Layer
- ❑ PIN Personal Identification Number
- ❑ RF Radio Frequency
- ❑ RFCOMM Radio Frequency Communication
- ❑ RFID Radio Frequency Identifier
- ❑ SCO Synchronous Connection Oriented
- ❑ SDP Service Discovery Protocol
- ❑ SG Study Group
- ❑ SIG Special Interest Group

## Student Questions

# Acronyms (Cont)

- ❑ SIM Subscriber Identity Module
- ❑ TCS Telephony Control Specification
- ❑ TDD Time-division duplex
- ❑ TLV Type-Length-Value
- ❑ TV Television
- ❑ TX Transmit
- ❑ UAP Upper address part
- ❑ UCD Unicast Connectionless Data
- ❑ URL Uniform Resource Locator
- ❑ UUID Universally Unique Identifier
- ❑  $\mu$ W Micro-Watt
- ❑ WAN Wide Area Network
- ❑ WBS Wide Band Speed
- ❑ Wi-Fi Wireless Fidelity
- ❑ WiMAX Worldwide Interoperability for Microwave Access
- ❑ WPAN Wireless Personal Area Networks

## Student Questions

# Acronyms (Cont)

- ❑ WRAN      Wireless Regional Area Network
- ❑ XML      Extensible Markup Language

## Student Questions

**Scan This to Download These Slides**



Raj Jain

<http://rajjain.com>

**Student Questions**

[http://www.cse.wustl.edu/~jain/cse574-20/j\\_11ble.htm](http://www.cse.wustl.edu/~jain/cse574-20/j_11ble.htm)

# Related Modules



CSE567M: Computer Systems Analysis (Spring 2013),  
[https://www.youtube.com/playlist?list=PLjGG94etKypJEKjNAa1n\\_1X0bWWNyZcof](https://www.youtube.com/playlist?list=PLjGG94etKypJEKjNAa1n_1X0bWWNyZcof)

CSE473S: Introduction to Computer Networks (Fall 2011),  
[https://www.youtube.com/playlist?list=PLjGG94etKypJWOSPMh8Azcg5e\\_10TiDw](https://www.youtube.com/playlist?list=PLjGG94etKypJWOSPMh8Azcg5e_10TiDw)



Recent Advances in Networking (Spring 2013),  
<https://www.youtube.com/playlist?list=PLjGG94etKypLHyBN8mOgwJLHD2FFIMGq5>

CSE571S: Network Security (Fall 2011),  
<https://www.youtube.com/playlist?list=PLjGG94etKypKvzfVtutHcPFJXumyyg93u>



Video Podcasts of Prof. Raj Jain's Lectures,  
<https://www.youtube.com/channel/UCN4-5wzNP9-ruOzQMs-8NUw>

## Student Questions