

Networking Layer Protocols for Internet of Things: 6LoWPAN and RPL



Raj Jain

Washington University in Saint Louis

Saint Louis, MO 63130

Jain@cse.wustl.edu

These slides and audio/video recordings of this class lecture are at:

<http://www.cse.wustl.edu/~jain/cse574-20/>

Student Questions



- ❑ 6LoWPAN
 - Adaptation Layer
 - Address Formation
 - Compression
- ❑ RPL
 - RPL Concepts
 - RPL Control Messages
 - RPL Data Forwarding

Note: This is part 3 of a series of class lectures on IoT.

Student Questions

Recent Protocols for IoT

Session	MQTT, SMQTT, CoRE, DDS, AMQP, XMPP, CoAP, IEC, IEEE 1888, ...	Security	Management		
Network	Encapsulation: 6LoWPAN , 6TiSCH, 6Lo, Thread...			IEEE 1888.3, TCG, Oath 2.0, SMACK, SASL, EDSA, ace, DTLS, Dice, ...	IEEE 1905, IEEE 1451, IEEE 1377, IEEE P1828, IEEE P1856
	Routing: RPL , CORPL, CARP				
Datalink	Wi-Fi, Bluetooth Low Energy, Z-Wave, ZigBee Smart, DECT/ULE, 3G/LTE, NFC, Weightless, HomePlug GP, 802.11ah, 802.15.4e, G.9959, WirelessHART, DASH7, ANT+, LTE-A, LoRaWAN, ISA100.11a, DigiMesh, WiMAX, ...				

Student Questions

Ref: Tara Salman, Raj Jain, "A Survey of Protocols and Standards for Internet of Things," Advanced Computing and Communications, Vol. 1, No. 1, March 2017, http://www.cse.wustl.edu/~jain/papers/iot_accs.htm
 Washington University in St. Louis <http://www.cse.wustl.edu/~jain/cse574-20/> ©2020 Raj Jain

IEEE 802.15.4

- ❑ Wireless Personal Area Network (WPAN)
- ❑ Allows mesh networking.
Full function nodes can forward packets to other nodes.
- ❑ A PAN coordinator (like Wi-Fi Access Point) allows nodes to join the network.
- ❑ Nodes have 64-bit addresses
- ❑ Coordinator assigns 16-bit short address for use during the association
- ❑ Maximum frame size is 127 bytes

Student Questions

EUI64 Addresses

- ❑ **Ethernet addresses:** 48 bit MAC

Unicast Multicast	Universal Local	Organizationally Unique ID (OUI)	Manufacturer Assigned
1b	1b	22b	24b

- ❑ **IEEE 802.15.4 Addresses:** 64 bit Extended Unique Id (EUI)

Unicast Multicast	Universal Local	Organizationally Unique ID (OUI)	Manufacturer Assigned
1b	1b	22b	40b

- ❑ **Local bit** was incorrectly assigned. $L=1 \Rightarrow$ Local
but all-broadcast address = all 1's is not local
IETF RFC4291 changed the meaning so that $L=0 \Rightarrow$ Local
The 2nd bit is now called Universal bit (U-bit)
 \Rightarrow U-bit formatted EUI64 addresses

Student Questions

6LowPAN

- ❑ IPv6 over Low Power Wireless Personal Area Networks
- ❑ How to transmit IPv6 datagrams (elephants) over low power IoT devices (mice)?

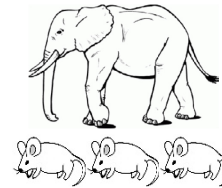

❑ Issues:

1. **IPv6 address formation:** 128-bit IPv6 from 64-bit EUI64
2. **Maximum Transmission Unit (MTU):** IPv6 at least 1280 bytes vs. IEEE 802.15.4 standard packet size is 127 bytes



3. **Address Resolution:** 128b or 16B IPv6 addresses. 802.15.4 devices use 64 bit (no network prefix) or 16 bit addresses
4. **Optional mesh routing in datalink layer**
⇒ Need destination and intermediate addresses.



Student Questions

Ref: G. Montenegro, et al., "Transmission of IPv6 Packets over IEEE 802.15.4 Networks," RFC 4944, Sep 2007, <http://tools.ietf.org/pdf/rfc4944>

6LowPAN Adaptation Layer

5. MAC-level retransmissions versus end-to-end:

- Optional hop-by-hop ack feature of 802.15.4 is used but the max number of retransmissions is kept low (to avoid overlapping L2 and L4 retransmissions)

6. Extension Headers: 8b *or less* Shannon-coded dispatch ⇒ header type

- 10_2 : Mesh addressing header (2-bit dispatch)
- $11x00_2$: Destination Processing Fragment header (5-bit)
- 01010000_2 : Hop-by-hop LowPAN Broadcast header (8-bit)

7. IPv6 and UDP header compression

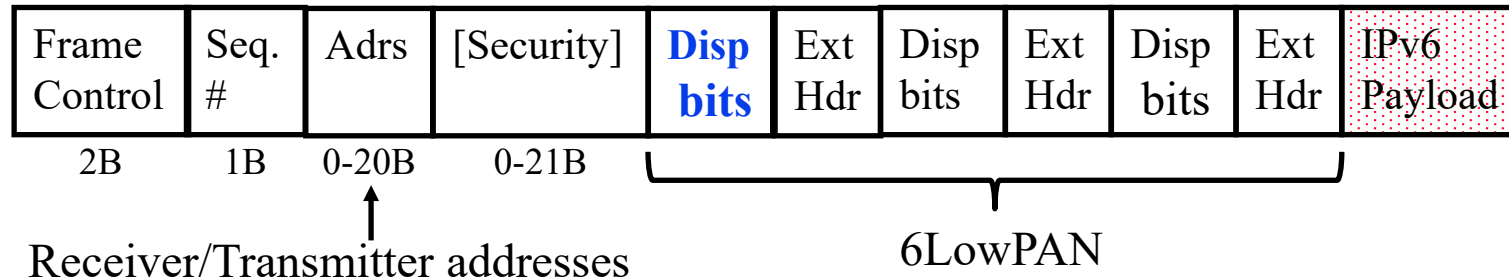

Student Questions

Ref: O. Hersent, et al., "The Internet of Things: Key Applications and Protocols," Wiley, 2013, 344 pp., ISBN: 9781119994350 (Safari Book)

Washington University in St. Louis

<http://www.cse.wustl.edu/~jain/cse574-20/>

©2020 Raj Jain

IPv6 Address Formation

- ❑ **Link-Local IPv6 address** = FE80::U-bit formatted EUI64
- ❑ **Example:**
 - EUI64 Local Address = 40::1 = 0100 0000::0000 0001
 - U-bit formatted EUI64 = 0::1
 - IPv6 Link-local address = FE80::1 = 1111 1110 1000 0000::1
- ❑ IEEE 802.15.4 allows nodes to have 16-bit **short addresses** and each PAN has a 16-bit **PAN ID**.
1st bit of Short address and PAN ID is Unicast/Multicast
The 2nd bit of Short Address and PAN ID is Local/Universal.
You can broadcast to all members of a PAN or to all PANs.
- ❑ IPv6 Link Local Address = FE80 :: PAN ID : Short Address
Use 0 if PAN ID is unknown.
2nd bit of PAN ID should always be zero since it is always local.
(2nd most significant = 6th bit from right)

Student Questions

Homework 14A

- ❑ What is the IPv6 Link-Local address for a IEEE 802.15.4 node whose EUI64 address in hex is 0000::0002. Indicate your final answer in hex without using ::
- ❑ EUI64 in Binary =
- ❑ U-bit EUI64 Binary =
- ❑ U-bit EUI64 Hex =
- ❑ IPv6 Link Local Address =

Student Questions

Mesh Addressing Header

- Dispatch = 10_2 (2 bits) \Rightarrow Mesh Addressing Header
- MAC header contains only originator and final addresses. each FFD node on the path looks up the final address in its routing table \Rightarrow Mesh routing not path routing. Transmitter and receiver addresses are up front in IEEE802.15 header.
- A 4-bit hops-left field is decremented at each hop

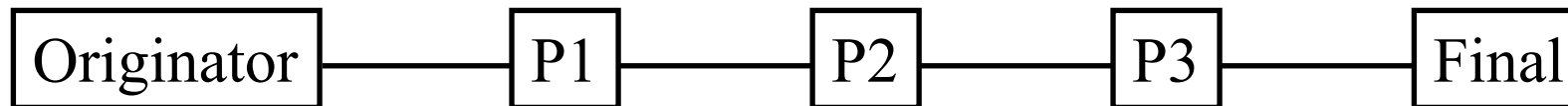

Dispatch	V	F	Hops Left	Originator Address	Final Address
10					
2b	1b	1b	4b	16b/64b	16b/64bit

V=0 \Rightarrow Originator address is EUI64, V=1 \Rightarrow 16bit

F=0 \Rightarrow Final address is EUI64, F=1 \Rightarrow 16-bit

Student Questions

6LowPAN Broadcast Header

- ❑ For Mesh broadcast/multicast
- ❑ A new sequence number is put in every broadcast message by the originator

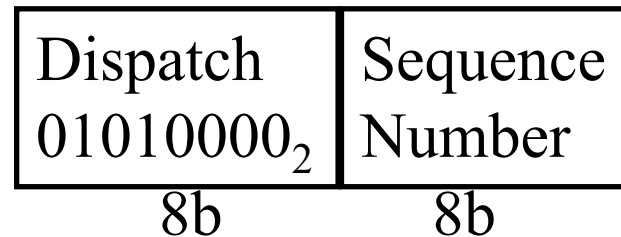

Student Questions

6LowPAN Fragment Header

- ❑ Dispatch = 11x00 (5 bits) \Rightarrow Fragment Header
- ❑ Full packet size in the first fragment's fragment header
- ❑ Datagram tag = sequence number
 \Rightarrow Fragments of the same packet
- ❑ Fragment Offset in multiples of 8 bytes

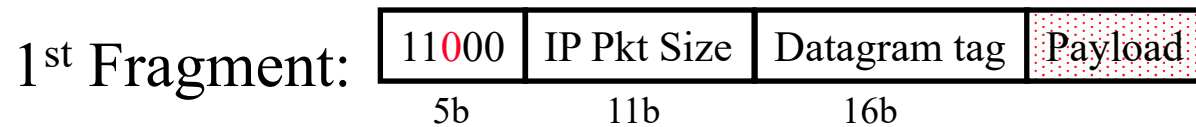

Student Questions

IP+UDP Header Compression: Stateless

- ❑ Called **HC1-HC2 compression** (not recommended)
- ❑ IP version field is omitted
- ❑ Flow label field if zero is omitted and C=1
- ❑ Only 4b UDP ports are sent if between 61616-61631 (F0Bx)
- ❑ UDP length field is omitted. IP addresses are compressed.

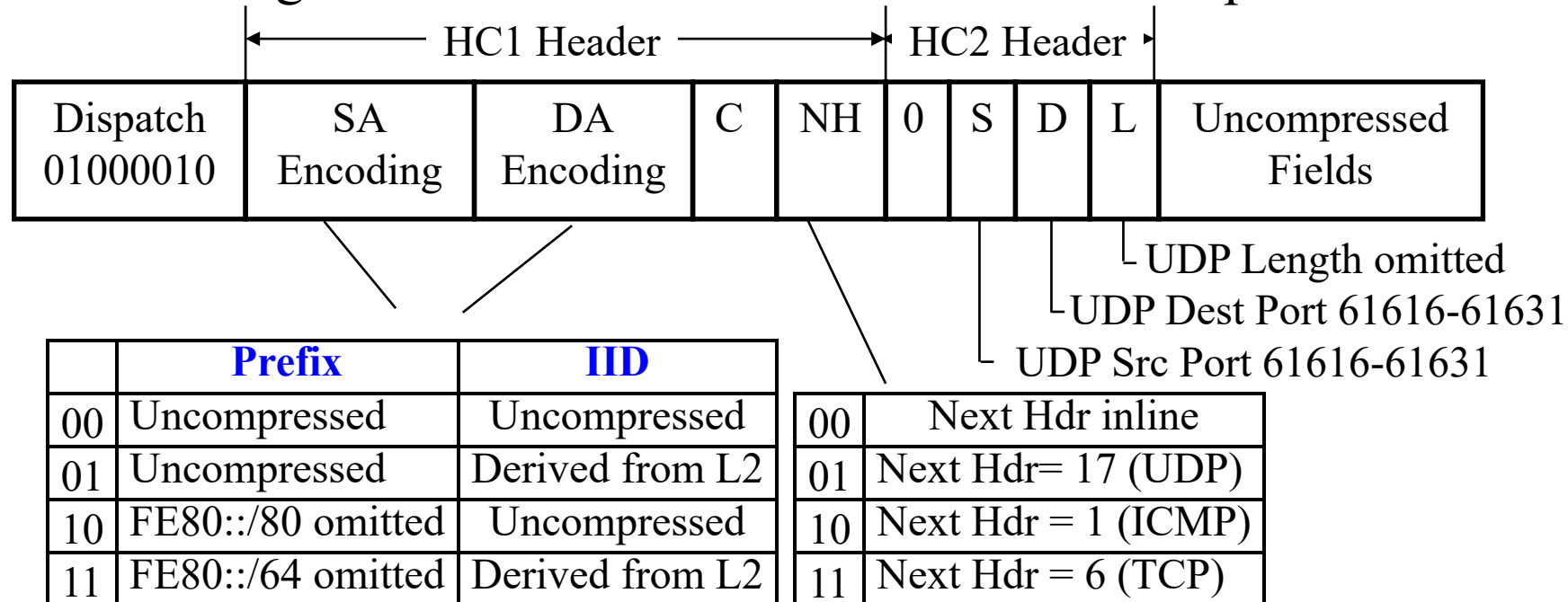

Student Questions

Context Based Compression

- ❑ HC1 works only with **link-local** addresses
- ❑ Need globally routable IPv6 addresses for outside nodes
- ❑ IPHC uses a 3b dispatch code and a 13-bit base header

Disp 011	TF	NH	Hop Limit	CID	SAC	SAM	M	DAC	DAM	SCI	DCI	Uncompressed IPv6 fields
-------------	----	----	--------------	-----	-----	-----	---	-----	-----	-----	-----	-----------------------------

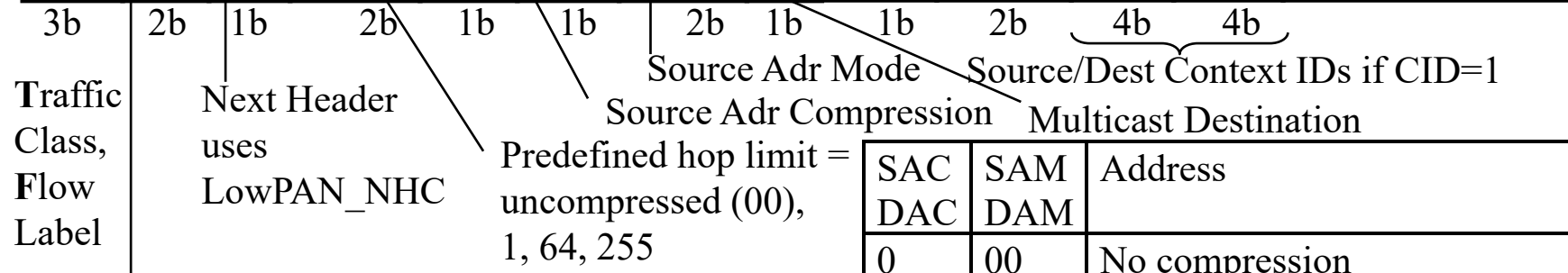

00	ECN+DSCP+4b pad+ 20b Flow label (4 Bytes)
01	ECN +2b pad + 12b Flow label (2 Bytes), DSCP omitted
10	ECN+DSCP (1B), Flow label omitted
11	ECN+DSCP+Flow label omitted

SAC DAC	SAM DAM	Address
0	00	No compression
0	01	First 64-bits omitted
0	10	First 112 bits omitted
0	11	128 bits omitted. Get from L2
1	00	Unspecified Address ::
1	01	First 64 bits from context
1	10	First 112 bits from context
1	11	128 bits from context and L2

Student Questions

Ref: O. Hersent, et al., "The Internet of Things: Key Applications and Protocols," Wiley, 2013, 344 pp., ISBN: 9781119994350 (Safari Book)
 Washington University in St. Louis <http://www.cse.wustl.edu/~jain/cse574-20/> ©2020 Raj Jain

Context Based Compression (Cont)

❑ If the next header uses LowPAN_NHC

➤ For IPv6 base extension headers:

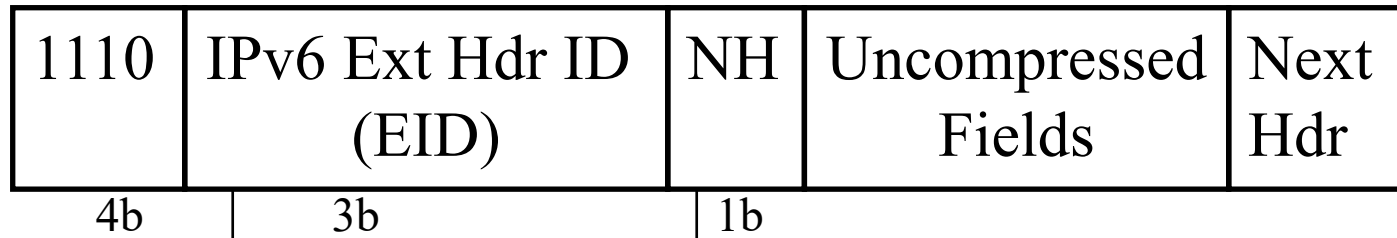

0 = Uncompressed
1 = LowPAN_NHC encoded

EID	Header
0	IPv6 Hop-by-Hop Options
1	IPv6 Routing
2	IPv6 Fragment
3	IPv6 Destination Options
4	IPv6 Mobility Header
5	Reserved
6	Reserved
7	IPv6 Header

LowPAN_NHC UDP Header:

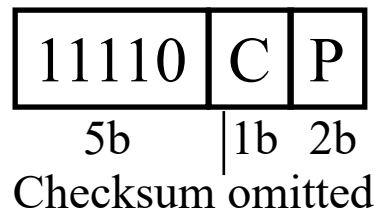

00	All 16-bits in line
01	1 st 8-bits of dest port omitted
10	1 st 8-bits of src port omitted
11	1 st 12-bits of src & dest omitted

Student Questions

Ref: J. Hui and P. Thubert, "Compression Format for IPv6 Datagrams over IEEE 802.15.4-Based Networks," IETF RFC 6282, Sep 2011, <http://tools.ietf.org/pdf/rfc6282>

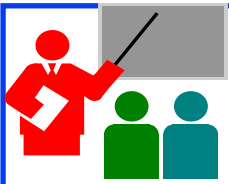

6LowPAN: Summary

❑ 3 New Headers:

- Mesh addressing: Intermediate addresses
- Hop-by-Hop: Mesh broadcasts
- Destination processing: Fragmentation

❑ **Address Formation:** 128-bit addresses by prefixing FE80::

❑ **Header compression:**

- HC1+HC2 header for link-local IPv6 addresses
- IPHC compression for all IPv6 addresses

Student Questions

Routing Protocol for Low-Power and Lossy Networks (RPL)

- ❑ Developed by IETF Routing over Low-Power and Lossy Networks (ROLL) working group
- ❑ Low-Power and Lossy Networks (LLN) Routers have constraints on processing, memory, and energy.
⇒ Can't use OSPF, OLSR, RIP, AODV, DSR, etc.
- ❑ LLN links have high loss rate, low data rates, and instability
⇒ expensive bits, dynamically formed topology
- ❑ Covers both wireless and wired networks
Requires bidirectional links. May be symmetric/asymmetric.
- ❑ Ideal for n-to-1 (data sink) communications, e.g., meter reading
1-to-n (multicast) and 1-to-1 possible with some extra work.
- ❑ Multiple LLN instances on the same physical networks

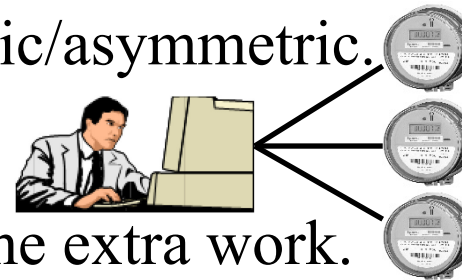

Student Questions

Ref: T. Winder, Ed., et al., "RPL: IPv6 Routing Protocol for Low-Power and Lossy Networks," IETF RFC 6550, Mar 2012,
<https://datatracker.ietf.org/doc/rfc6550/>

RPL Concepts

- ❑ **Directed Acyclic Graph (DAG):** No cycles
- ❑ **Root:** No outgoing edge
- ❑ **Destination-Oriented DAG (DODAG):** Single root
- ❑ **Up:** Towards root
- ❑ **Down:** Away from root
- ❑ **Objective Function:** Minimize energy, latency, ...
- ❑ **Rank:** Distance from root using specified objective
- ❑ **RPL Instance:** One or more DODAGs.
A node may belong to multiple RPL instances.
- ❑ **DODAG ID:** IPv6 Adr of the root
- ❑ **DODAG Version:** Current version of the DODAG. Every time a new DODAG is computed with the same root, its version incremented.

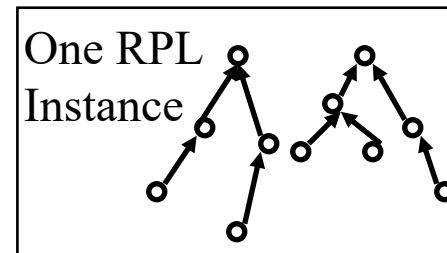
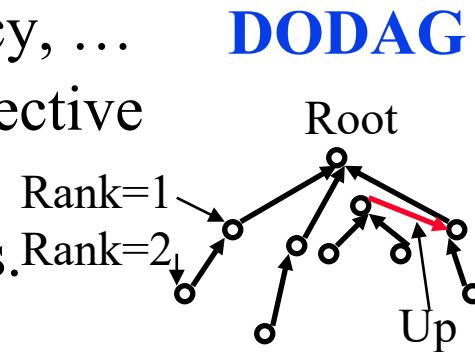
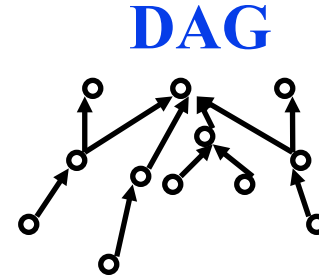

Student Questions

RPL Concepts (Cont)

- ❑ **Goal:** Reachability goal, e.g., connected to database
- ❑ **Grounded:** Root can satisfy the goal
- ❑ **Floating:** Not grounded. Only in-DODAG communication.
- ❑ **Parent:** Immediate successor towards the root
- ❑ **Sub-DODAG:** Sub tree rooted at this node
- ❑ **Storing:** Nodes keep routing tables for sub-DODAG
- ❑ **Non-Storing:** Nodes know only parent. Do not keep a routing table.

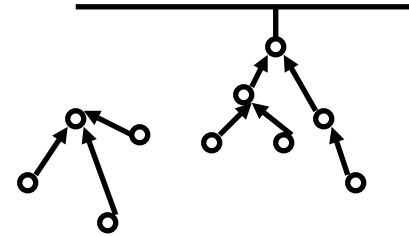

Student Questions

RPL Control Messages

- DODAG Information Object (DIO):**
 - Downward RPL instance multicasts
 - Allows other nodes to discover an RPL instance and join it
- DODAG Information Solicitation (DIS):**
 - Link-Local **multicast** request for DIO (neighbor discovery).
Do you know of any DODAGs?
- Destination Advertisement Object (DAO):**
 - From child to parents or root.
 - Can I join you as a child on DODAG #x?
- DAO Ack:** Yes, you can! Or Sorry, you cant!
- Consistency Check:** Challenge/response messages for security

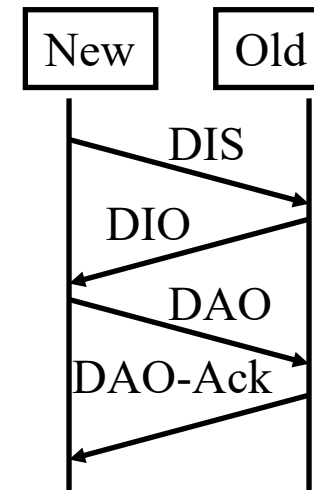
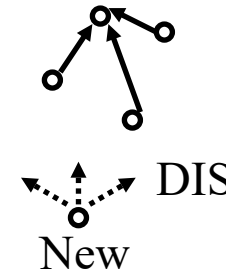

Student Questions

Ref: S. Kuryla, "RPL:IPv6 Routing Protocol for Low Power and Lossy Networks,"

<http://cnds.eecs.jacobs-university.de/courses/nds-2010/kuryla-rpl.pdf>

Washington University in St. Louis

<http://www.cse.wustl.edu/~jain/cse574-20/>

©2020 Raj Jain

DODAG Formation Example

1. A multicasts DIOs that it's member of DODAG ID itself with Rank 0.
2. B, C, D, E hear and determine that their rank (distance) is 1, 1, 3, 4, respectively from A
3. B, C, D, E send DAOs to A.
4. A accepts all
5. B and C multicast DIOs
6. D hears those and determines that its distance from B and C is 1, 2
7. E hears both B, C and determines that its distance from B and C is 2, 1
8. D sends a DAO to B
E sends a DAO to C
9. B sends a DAO-Ack to D
C sends a DAO-Ack to E

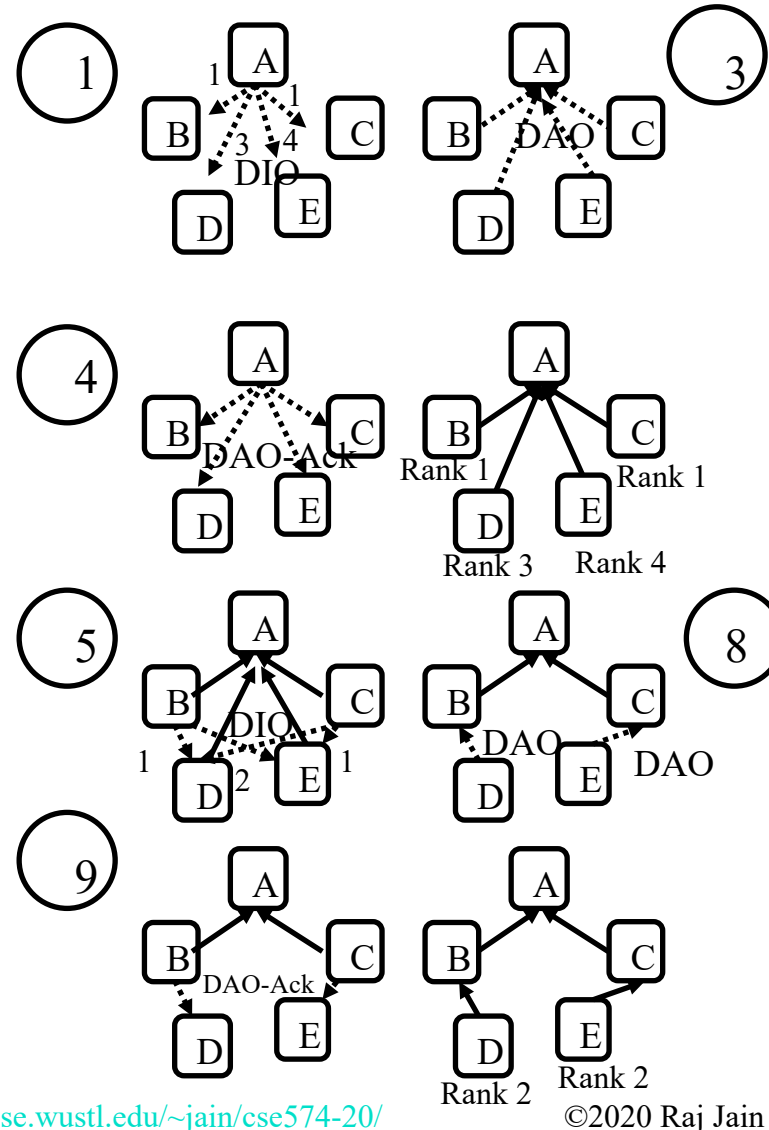

Student Questions

RPL Data Forwarding

- ❑ Case 1: To the root (n-to-1)
 - Address to root and give to parent
- ❑ Case 2: A to B
 - 2A: Storing (Everyone keeps a routing table)
 - ❑ Forward up from A to common parent
 - ❑ Forward down from common parent to B
 - 2B: Non-storing (No routing tables except at root)
 - ❑ Forward up from A to root
 - ❑ Root puts a source route and forwards down
- ❑ Case 2: Broadcast from the root (1-to-n)
 - 2A: Storing (everyone knows their children)
 - ❑ Broadcast to children
 - 2B: Non-Storing (Know only parents but not children)
 - ❑ Root puts a source route for each leaf and forwards

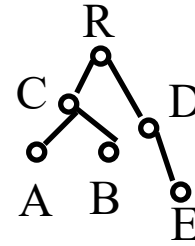

Student Questions

Homework 14B

- ❑ A. Which of the following is not a DODAG and why?
- ❑ B. What is the direction of Link A? (Up or Down):
- ❑ C. Assuming each link has a distance of 1, what is the rank of node B?
- ❑ D. Show the paths from B to C if the DODAG is non-storing.
- ❑ E. Show the paths from D to E if the DODAG is storing.

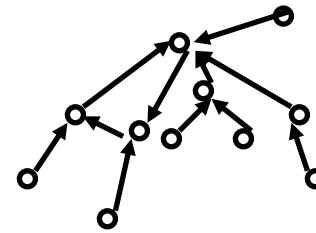
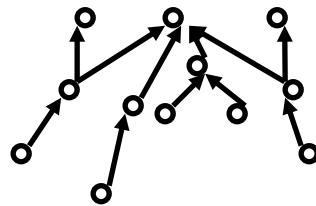
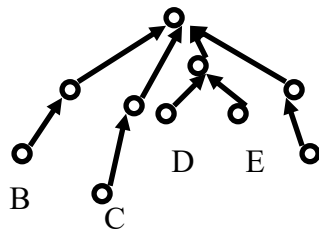
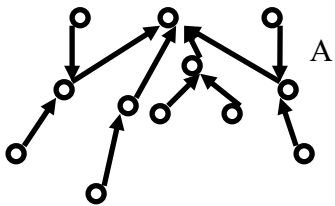

Student Questions

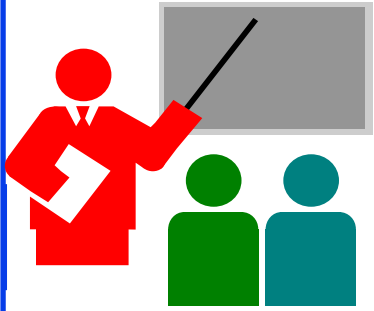

RPL Summary

1. An RPL instance consists of one or more DODAGs
2. DIO are broadcast downward,
DAOs are requests to join upward
DIS are DIO solicitations
DAO-ack are responses to DAO
3. Non-storing nodes do not keep any routing table and send everything upwards toward the root

Student Questions

Summary

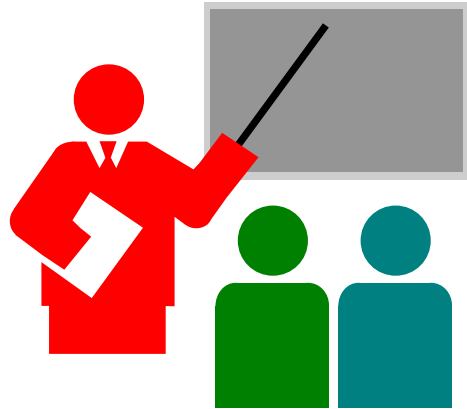

1. 6LowPAN is designed for IPv6 over IEEE 802.15.4
Frame size and address sizes are primary issues
Header compression is the key mechanism
2. RPL is designed primarily for data collection
No assumption about IEEE 802.15.4 or wireless or frame size
Routing is the primary issue
Forming a spanning tree like DODAG is the solution

Student Questions

Reading List

- ❑ O. Hersent, et al., “The Internet of Things: Key Applications and Protocols,” Wiley, 2013, 344 pp., ISBN: 9781119994350 (Safari Book)
- ❑ G. Montenegro, et al., “Transmission of IPv6 Packets over IEEE 802.15.4 Networks,” RFC 4944, Sep 2007, <http://tools.ietf.org/pdf/rfc4944>
- ❑ J. Hui and P. Thubert, “Compression Format for IPv6 Datagrams over IEEE 802.15.4-Based Networks,” IETF RFC 6282, Sep 2011, <http://tools.ietf.org/pdf/rfc6282>
- ❑ T. Winder, Ed., et al., "RPL: IPv6 Routing Protocol for Low-Power and Lossy Networks," IETF RFC 6550, Mar 2012, <https://datatracker.ietf.org/doc/rfc6550/>
- ❑ S. Kuryla, “RPL: IPv6 Routing Protocol for Low Power and Lossy Networks,” <http://cnds.eecs.jacobs-university.de/courses/nds-2010/kuryla-rpl.pdf>

Student Questions

Wikipedia Links

- ❑ <http://en.wikipedia.org/wiki/6LoWPAN>
- ❑ http://en.wikipedia.org/wiki/IEEE_802.15.4
- ❑ http://en.wikipedia.org/wiki/MAC_address
- ❑ <http://en.wikipedia.org/wiki/IPv6>
- ❑ http://en.wikipedia.org/wiki/IPv6_address
- ❑ http://en.wikipedia.org/wiki/Organizationally_unique_identifier
- ❑ http://en.wikipedia.org/wiki/IPv6_packet
- ❑ http://en.wikipedia.org/wiki/Link-local_address

Student Questions

References

- ❑ N. Kushalnagar, et al., "IPv6 over Low-Power Wireless Personal Area Networks (6LoWPANs): Overview, Assumptions, Problem Statement, and Goals", IETF RFC 4919, Aug 2007, <http://www.rfc-editor.org/rfc/pdf/rfc4919.txt.pdf>
- ❑ G. Montenegro, N. Kushalnagar, J. Hui, D. Culler, "Transmission of IPv6 Packets over IEEE 802.15.4 Networks," IETF RFC 4944, <https://tools.ietf.org/pdf/rfc4944>
- ❑ J. Hui, Ed., P. Thubert, "Compression Format for IPv6 Datagrams over IEEE 802.15.4-Based Networks," IETF RFC 6282, Sept 2011, <https://tools.ietf.org/html/rfc6282>
- ❑ E. Kim, et al., "Design and Application Spaces for IPv6 over Low-Power Wireless Personal Area Networks (6LoWPANs)," IETF RFC 6568, Apr 2012, <http://www.rfc-editor.org/rfc/pdf/rfc6568.txt.pdf>
- ❑ E. Kim, et al., "Problem Statement and Requirements for IPv6 over Low-Power Wireless Personal Area Network (6LoWPAN) Routing," IETF RFC 6606, May 2012, <http://www.rfc-editor.org/rfc/pdf/rfc6606.txt.pdf>
- ❑ Z. Shelby, et al., "Neighbor Discovery Optimization for IPv6 over Low-Power Wireless Personal Area Networks (6LoWPANs), IETF RFC 6775, Nov. 2012, <http://www.rfc-editor.org/rfc/pdf/rfc6775.txt.pdf>

Student Questions

References (Cont)

- ❑ "Routing Requirements for Urban Low-Power and Lossy Networks," IETF RFC 5548, May 2009, <https://datatracker.ietf.org/doc/rfc5548/>
- ❑ "Industrial Routing Requirements in Low-Power and Lossy Networks," IETF RFC 5673, Oct 2009, <https://datatracker.ietf.org/doc/rfc5673/>
- ❑ "Home Automation Routing Requirements in Low-Power and Lossy Networks," IETF RFC 5826, Apr 2010, <https://datatracker.ietf.org/doc/rfc5826/>
- ❑ "Building Automation Routing Requirements in Low-Power and Lossy Networks," IETF RFC 5867, Jun 2010, <https://datatracker.ietf.org/doc/rfc5867/>
- ❑ "The Trickle Algorithm," IETF RFC 6206, Mar 2011, <https://datatracker.ietf.org/doc/rfc6206/>
- ❑ "RPL: IPv6 Routing Protocol for Low-Power and Lossy Networks," IETF RFC 6550, Mar 2012, <https://datatracker.ietf.org/doc/rfc6550/>
- ❑ "Routing Metrics Used for Path Calculation in Low-Power and Lossy Networks," IETF RFC 6551, Mar 2012, <https://datatracker.ietf.org/doc/rfc6551/>
- ❑ "Objective Function Zero for the Routing Protocol for Low-Power and Lossy Networks (RPL)," IETF RFC 6552, Mar 2012, <https://datatracker.ietf.org/doc/rfc6552/>

Student Questions

References (Cont)

- ❑ "The Minimum Rank with Hysteresis Objective Function," IETF RFC 6719, Sep 2012, <https://datatracker.ietf.org/doc/rfc6719/>
- ❑ "Reactive Discovery of Point-to-Point Routes in Low-Power and Lossy Networks," IETF RFC 6997, Aug 2013, <https://datatracker.ietf.org/doc/rfc6997/>
- ❑ "A Mechanism to Measure the Routing Metrics along a Point-to-Point Route in a Low-Power and Lossy Network," IETF RFC 6998, Aug 2013, <https://datatracker.ietf.org/doc/rfc6998/>

Student Questions

Acronyms

- ❑ 6LowPAN IPv6 over Low Power Wireless Personal Area Network
- ❑ AODV Ad-hoc On-demand Distance Vector
- ❑ AQMP Advanced Queueing Message Protocol
- ❑ ARC-EM4 Name of a product
- ❑ ARM Acorn RISC Machine
- ❑ CC Consistency Check
- ❑ CID Context ID
- ❑ CoAP Constrained Application Protocol
- ❑ CoRE Constrained Restful Environment
- ❑ DA Destination Address
- ❑ DAC Destination Address Compression
- ❑ DAG Directed Acyclic Graph
- ❑ DAM Destination Address Mode
- ❑ DAO DODAG Advertisement Object
- ❑ DCI Destination Context ID
- ❑ DDS Data Distribution Service

Student Questions

Acronyms (Cont)

- ❑ DECT Digital Enhanced Cordless Telecommunication
- ❑ DIO DODAG Information Object
- ❑ DIS DODAG Information Solicitation
- ❑ DODAG Destination Oriented Directed Acyclic Graph
- ❑ DSCP Differentiated Services Control Point
- ❑ DSR Dynamic Source Routing
- ❑ DTLS Datagram Transport Level Security
- ❑ ECN Explicit Congestion Notification
- ❑ EID IPv6 Extension Header ID
- ❑ EUI Extended Unique Id
- ❑ GP GreenPHY
- ❑ HC Header Compression
- ❑ HC1-HC2 Header Compression 1 and Header Compression 2
- ❑ ICMP IP Control Message Protocol
- ❑ ID Identifier
- ❑ IEEE Institution of Electrical and Electronic Engineers

Student Questions

Acronyms (Cont)

- ❑ IETF Internet Engineering Task Force
- ❑ IID Interface Identifier
- ❑ IoT Internet of Things
- ❑ IP Internet Protocol
- ❑ IPHC IP Header Compression
- ❑ IPv6 Internet Protocol Version 6
- ❑ ISASecure Security certification by
- ❑ LLN Low-Power and Lossy Networks
- ❑ LoRaWAN Long Range Wide Area Network
- ❑ LTE Long-Term Evolution
- ❑ MAC Media Access Control
- ❑ MTU Maximum Transmission Unit
- ❑ NFC Near Field Communication
- ❑ NH Next Header
- ❑ NHC Next Header Compression
- ❑ OLSR On-Demand Link State Routing

Student Questions

Acronyms (Cont)

- ❑ OSPF Open Shortest Path Forwarding
- ❑ PAN Personal Area Network
- ❑ RFC Request for Comments
- ❑ RIP Routing Information Protocol
- ❑ ROLL Routing over Low-Power and Lossy Networks
- ❑ RPL Routing Protocol for Low-Power and Lossy Networks
- ❑ SA Source Address
- ❑ SAC Source Address Compression
- ❑ SAM Source Address Mode
- ❑ SASL Simple Authentication and Security Layer
- ❑ SCI Source Context ID
- ❑ SMACK Simplified Mandatory Access Control Kernel
- ❑ TCG Trusted Computing Group
- ❑ TCP Transmission Control Protocol
- ❑ TF Traffic Class, Flow Label
- ❑ TinyOS Tiny Operating System

Student Questions

Acronyms (Cont)

- ❑ UDP User Datagram Protocol
- ❑ ULE Ultra Low Energy
- ❑ Wi-Fi Wireless Fidelity
- ❑ WirelessHART Wireless Highway Addressable Remote Transducer Protocol
- ❑ WPAN Wireless Personal Area Network

Student Questions



Little Endians vs. Big Endians

- Endianness = **Byte** order in a word
- Question 1: How should we write 16,909,060?
 - Answer: $16,909,060 = 1 \times 2^{24} + 2 \times 2^{16} + 3 \times 2^8 + 4$
- Question 2: How should we **store bytes in a word** in the memory?
 - Answer 2A:

Byte 0	Byte 1	Byte 2	Byte 3
--------	--------	--------	--------

4	3	2	1
---	---	---	---
 - Answer 2B:

Byte 3	Byte 2	Byte 1	Byte 0
--------	--------	--------	--------

1	2	3	4
---	---	---	---
- Two tribes (Machine Architectures):
 - Big Endians: Most Significant Byte (MSB) first
 - Little Endians: Least Significant Byte (LSB) first

1	2	3	4
---	---	---	---

Student Questions

Ref: Raj Jain, "FDDI Handbook: High Speed Networking with Fiber and Other Media," Addison Wesley, Reading, MA April 1994



little endians vs. big endians

- ❑ **endianness** = **bit order** in a Byte
- ❑ Question: How should we write 11_{10} ?
- ❑ Answer: $11_{10} = B_{16} = 1011_2$
- ❑ Question 3: How should we **store bits in a byte** in the memory?
- ❑ Answer 3A:

bit 0	bit 1	bit 2	bit 3	bit 4	bit 5	bit 6	bit 7	1	1	0	1	...
-------	-------	-------	-------	-------	-------	-------	-------	---	---	---	---	-----
- ❑ Answer 3B:

bit 7	bit 6	bit 5	bit 4	bit 3	bit 2	bit 1	bit 0	...	1	0	1	1
-------	-------	-------	-------	-------	-------	-------	-------	-----	---	---	---	---

 - big endians: most significant bit (msb) first
 - little endians: least significant bit (lsb) first

Student Questions



little endians vs. big endians

- ❑ Both tribes lived peacefully until they were “networked”
- ❑ Networking folks started arguing in IEEE 802 around 1979-80.
- ❑ Question 4: How should we **transmit** 11_{10} on the wire?
 - Answer 4A:

bit 0	bit 1	bit 2	bit 3	bit 4	bit 5	bit 6	bit 7
-------	-------	-------	-------	-------	-------	-------	-------
 - Answer 4B:

bit 7	bit 6	bit 5	bit 4	bit 3	bit 2	bit 1	bit 0
-------	-------	-------	-------	-------	-------	-------	-------
- ❑ **Agreement:**
 - MSB, msb on the wire. Store as you like in your computer.
- ❑ Question 5: How do we **write the addresses** on paper?
 - lsb use dashes: xx-xx-xx-xx-xx-xx
 - msb use colon: xx:xx:xx:xx:xx
 - Most people are unaware of this notation and use : and – interchangeably and msb is first always.

Student Questions

IPv6

- ❑ Colon-Hex Notation: Eight 16-bit words
FEDC:0000:0000:0000:3243:0000:0000:ABCD
 - Can skip leading zeros of each word
 - Can skip one sequence of zero words, e.g.,
FEDC::<3243:0000:0000:ABCD
::3243:0000:0000:ABCD
- ❑ Network Prefix: First 64-bit are network address, last 64-bit are host address
- ❑ Local Addresses: Provide plug and play
 - Link Local: FE80::xxxx
 - Site Local: FEC0::xxxx

Raj V6 9IPv6),” Introduction to Computer Networking, Course Lecture, WUSTL 2005, http://www.cse.wustl.edu/~jain/cse473-05/i_eip6.htm

Student Questions

IPv6 (Cont)

- ❑ IPv6 header has no optional fields.
 - Fields were divided in to groups
 - One group is required (base header)
 - Other groups may or may not be present (Extension headers)
 - All headers have fixed format



- ❑ Extension Headers: Most extension headers are examined only at the destination
- ❑ Examples: Fragmentation Header, Routing Header (path routing), ...

Raj V6 9IPv6),” Introduction to Computer Networking, Course Lecture, WUSTL 2005, http://www.cse.wustl.edu/~jain/cse473-05/i_eip6.htm

Student Questions

Scan This to Download These Slides



Raj Jain

<http://rajjain.com>

Student Questions

http://www.cse.wustl.edu/~jain/cse574-20/j_14lpn.htm

Related Modules



CSE567M: Computer Systems Analysis (Spring 2013),
https://www.youtube.com/playlist?list=PLjGG94etKypJEKjNAa1n_1X0bWWNyZcof

CSE473S: Introduction to Computer Networks (Fall 2011),
https://www.youtube.com/playlist?list=PLjGG94etKypJWOSPMh8Azcg5e_10TiDw



Recent Advances in Networking (Spring 2013),
<https://www.youtube.com/playlist?list=PLjGG94etKypLHyBN8mOgwJLHD2FFIMGq5>

CSE571S: Network Security (Fall 2011),
<https://www.youtube.com/playlist?list=PLjGG94etKypKvzfVtutHcPFJXumyyg93u>



Video Podcasts of Prof. Raj Jain's Lectures,
<https://www.youtube.com/channel/UCN4-5wzNP9-ruOzQMs-8NUw>

Student Questions