

Introduction to 5G



Raj Jain

Washington University in Saint Louis

Saint Louis, MO 63130

Jain@cse.wustl.edu

Slides and Audio/Video recordings of this class lecture
are available at:

<http://www.cse.wustl.edu/~jain/cse574-20/>

Student Questions



1. What: 5G Definition, timeline, Applications
2. Frame Structure, Scalable OFDM
3. Massive MIMO, Beamforming
4. Core Network architecture, features
5. Current and future releases of 3GPP

Note: This is the 5th module in a series of lectures on 2G/3G, LTE, LTE-Advanced (4G), LTE-Advanced Pro (4.5G) and 5G

Student Questions

5G Definition

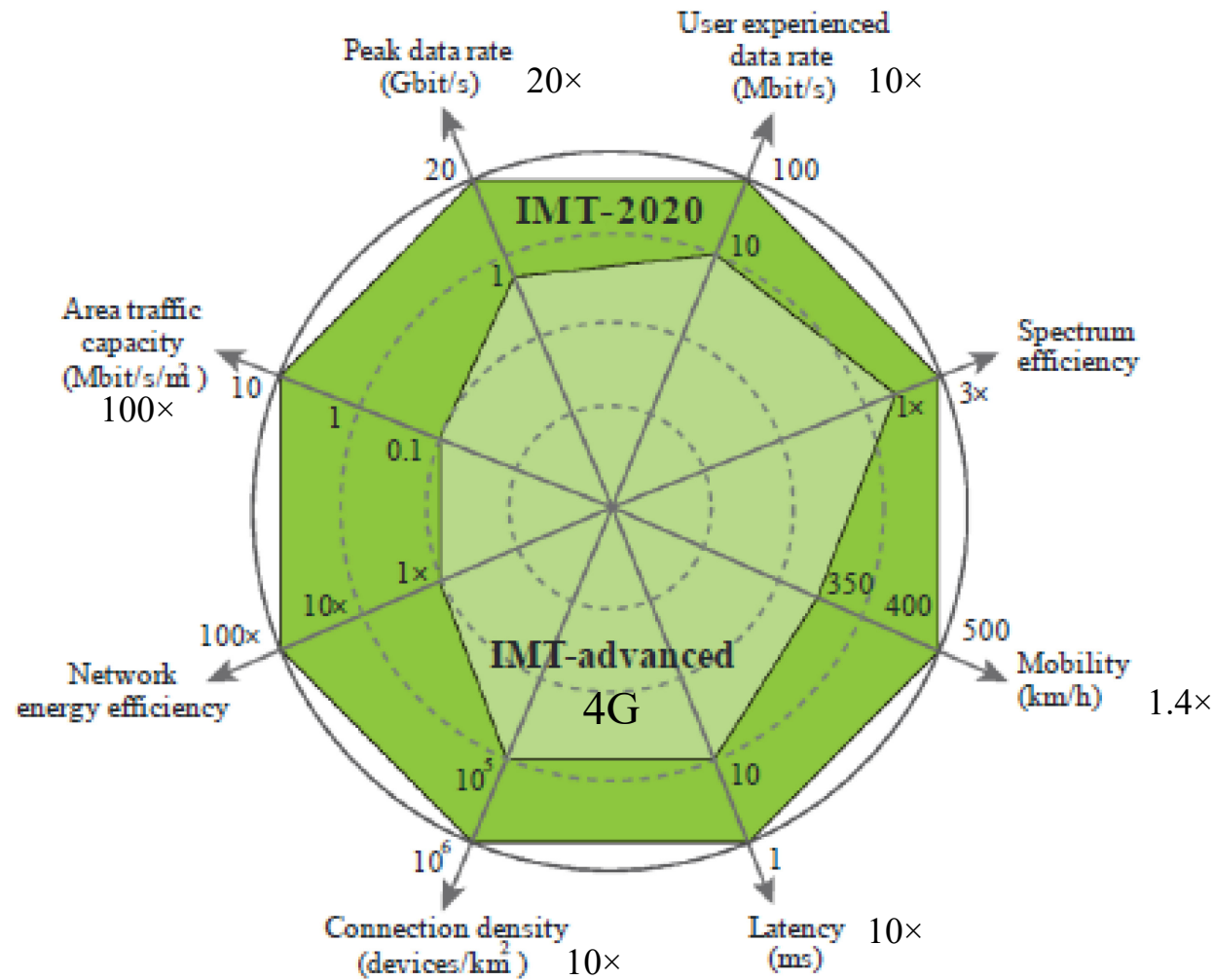

Student Questions

Ref: ITU-R Recommendation M.2083-0, "IMT Vision – Framework and overall objectives of the future development of IMT for 2020 and beyond," Sep. 2015, 21 pp., https://www.itu.int/dms_pubrec/itu-r/rec/m/R-REC-M.2083-0-201509-I!!PDF-E.pdf

Washington University in St. Louis

<http://www.cse.wustl.edu/~jain/cse574-20/>

©2020 Raj Jain

5G Definition (Cont)

1. **Peak Data Rate:** max rate per user under ideal conditions. 10 Gbps for mobiles, 20 Gbps under certain conditions.
2. **User experienced Data Rate:** 95% Rate across the coverage area per user. 100 Mbps in urban/suburban areas. 1 Gbps hotspot.
3. **Latency:** Radio contribution to latency between send and receive
4. **Mobility:** Max speed at which seamless handover and QoS is guaranteed
5. **Connection Density:** Devices per km²
6. **Energy Efficiency:** Network bits/Joule, User bits/Joule
7. **Spectrum Efficiency:** Throughput per Hz per cell
8. **Area Traffic Capacity:** Throughput per m²

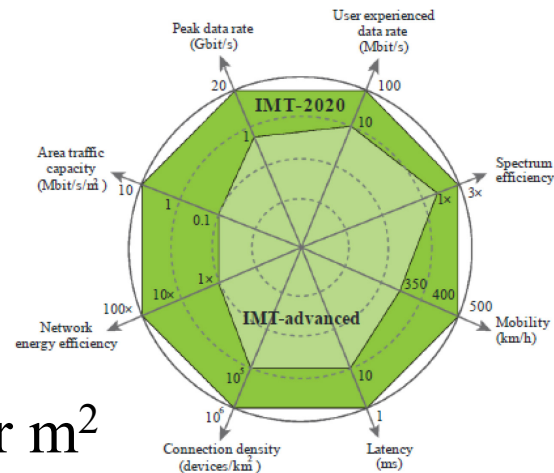

Student Questions

Additional Capabilities for 5G

1. **Spectrum and Bandwidth Flexibility:** Ability to operate at different frequencies and channel bandwidths
2. **Reliability:** High availability
3. **Resilience:** Continue working in face of disasters
4. **Security and Privacy:** Confidentiality, Integrity, Authentication, Protection against hacking, denial of service, man-in-the-middle attacks
5. **Operational Lifetime:** Long battery life

Student Questions

Ref: ITU-R Recommendation M.2083-0, "IMT Vision – Framework and overall objectives of the future development of IMT for 2020 and beyond," Sep. 2015, 21 pp., https://www.itu.int/dms_pubrec/itu-r/rec/m/R-REC-M.2083-0-201509-I!!PDF-E.pdf

3GPP Schedule

- ❑ 3G: IMT-2000 started in 1985, first release in 2000
- ❑ 4G: IMT-Advanced, vision in 2003, First release in 2012
- ❑ 5G: IMT-2020, vision in 2015, first release in 2020

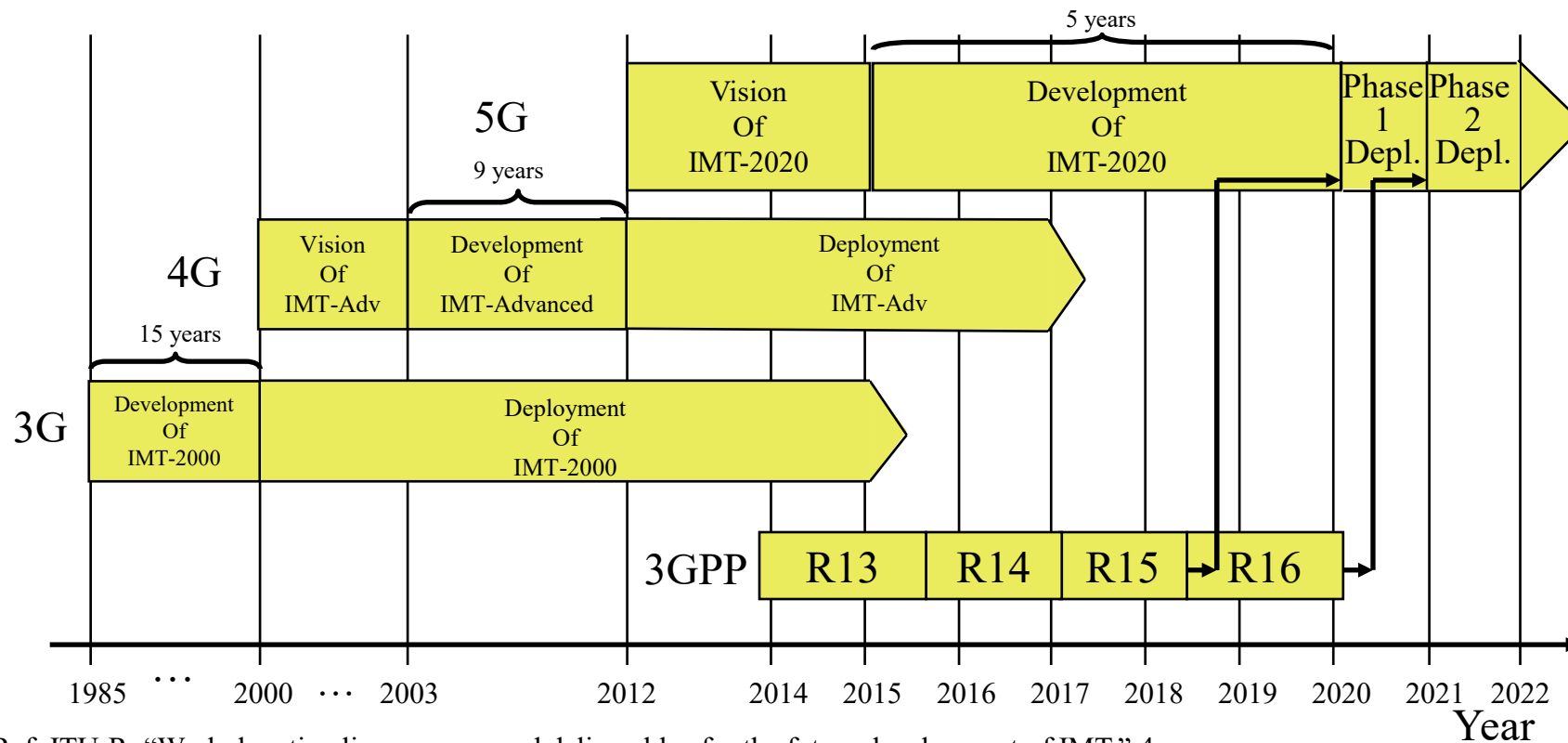

Ref: ITU-R, "Workplan, timeline, process and deliverables for the future development of IMT," 4pp.,
<http://www.itu.int/en/ITU-R/study-groups/rsg5/rwp5d/imt-2020/Documents/Antipated-Time-Schedule.pdf>

Student Questions

ITU-R Schedule

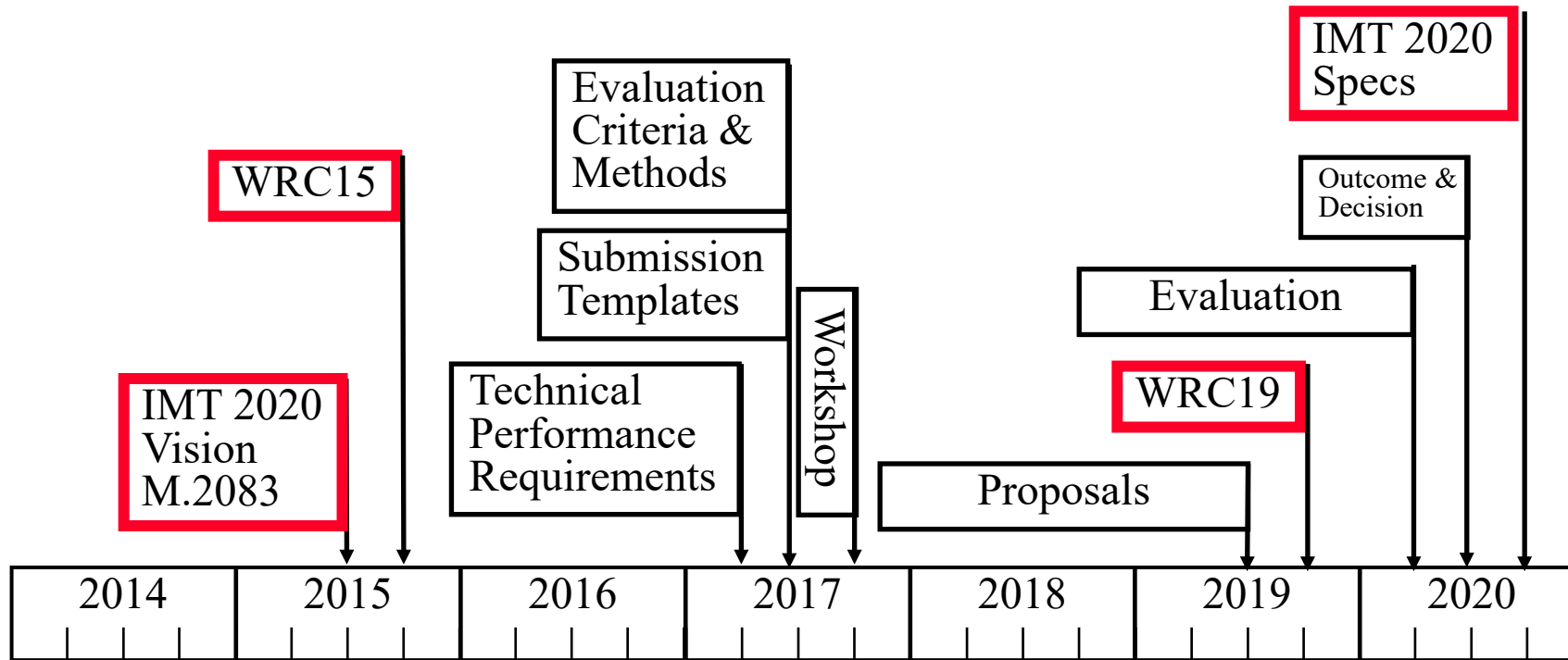

Student Questions

Ref: ITU-R, "Workplan, timeline, process and deliverables for the future development of IMT,"
ITU-R Document 5D/758, Attachment 2.12

ITU-R Schedule (Cont)

1. **Technical Requirements:** 13 minimum performance requirements [ITU-R M.2410]
 2. **Evaluation Guideline:** Configurations, test environments, and channel models [ITU-R M.2412]
 3. **Submission templates:** For submitting a candidate technology [ITU-R M.2411]
- ❑ Workshop on IMT-2020 was held in October 2017. Candidate proposals can now be submitted.
 - ❑ Radio Interface Specification for IMT-2020 will be published in 2020.

Student Questions

Ref: E. Dahlman, S. Parkvall, J. Skold, “5G NR – The Next Generation Wireless Access Technology,” Academic Press, 2018,
ISBN: [978-0-12-814323-0](https://doi.org/10.1016/j.5g.2018.08.001)

5G Applications

Three Key Application Areas:

1. **Enhanced Mobile Broadband (eMBB)**: Better mobile phones and hot spots. High data rates, high user density. Human centric communications
2. **Ultra-Reliable and Low-Latency Communications (URLLC)**: Vehicle-to-Vehicle communication, Industrial IoT, 3D Gaming. Human and Machine centric communication
3. **Massive Machine Type Communications (mMTC)**: Very large number of devices, low data rate, low power. IoT with long battery life time. Addition to GSM, LoRa, Zigbee, etc. Machine-centric communication.

Student Questions

5G Applications (Cont)

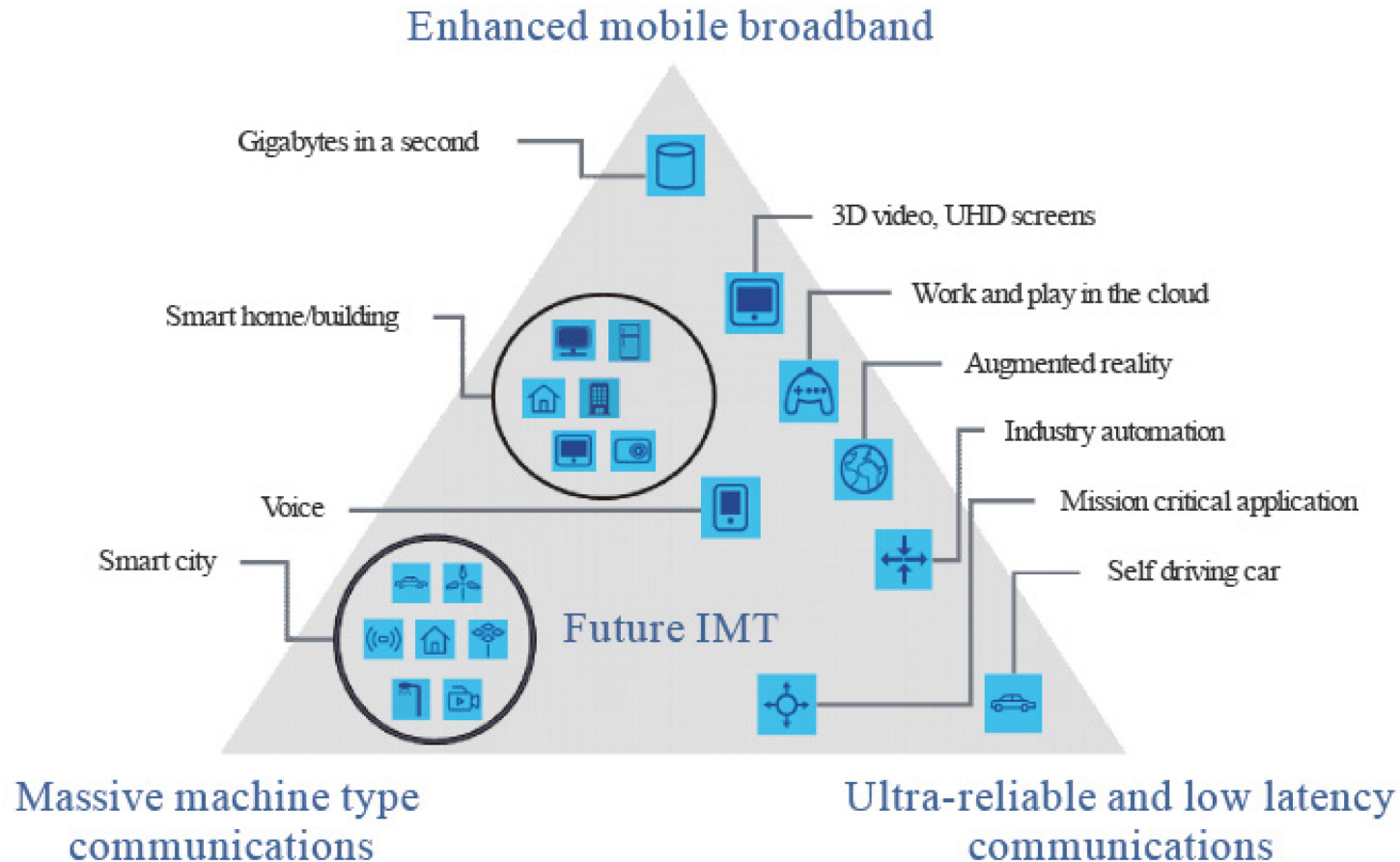

Student Questions

M.2083-02

Ref: ITU-R M.2083-0, "IMT Vision – Framework and overall objectives of the future development of IMT for 2020 and beyond," Sep. 2015. https://www.itu.int/dms_pubrec/itu-r/rec/m/R-REC-M.2083-0-201509-I!!PDF-E.pdf

Washington University in St. Louis

<http://www.cse.wustl.edu/~jain/cse574-20/>

©2020 Raj Jain

Application Requirements

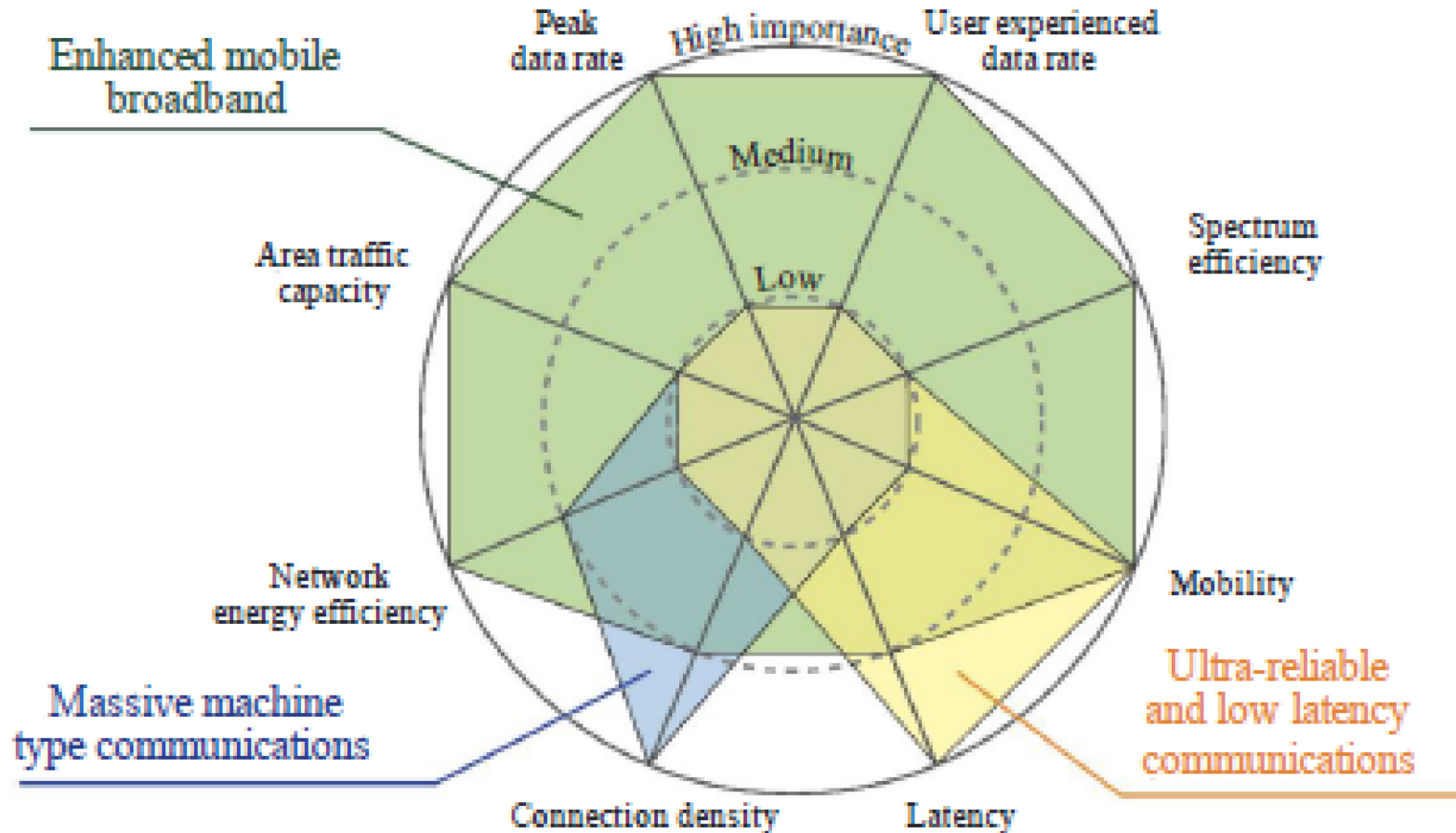

Student Questions

M.2083-04

Ref: ITU-R M.2083-0, "IMT Vision – Framework and overall objectives of the future development of IMT for 2020 and beyond," Sep. 2015. https://www.itu.int/dms_pubrec/itu-r/rec/m/R-REC-M.2083-0-201509-I!!PDF-E.pdf

Washington University in St. Louis

<http://www.cse.wustl.edu/~jain/cse574-20/>

©2020 Raj Jain

5G Requirements Template

Parameter	Min Requirement
Peak Data Rate	20 Gbps DL, 10 Gbps UL
Peak Spectral Efficiency	30 bps/Hz DL, 10 bps/Hz UL
User Experienced Data Rate	100 Mbps DL, 50 Mbps UL
Fifth-Percentile User Spectral Efficiency	3× 4G
Average User Spectral Efficiency	3× 4G
Area Traffic Capacity	10 Mbps/m ² (Indoor hot spot)
User Plane Latency	4 ms for eMBB, 1 ms for URLLC
Control Plane Latency	20 ms
Connection Density	1 M devices/km ²
Energy Efficiency	
Reliability	0.99999 probability of successful transmission in Urban macro cell edge for URLLC
Mobility	1.5× 4G
Mobility Interruption time	0 ms
Bandwidth	At least 100 MHz and up to 1 GHz in higher bands. Scalable bandwidth support required.

Ref: ITU-R M.2411-0, "Requirements, evaluation criteria and submission templates for the development of IMT-2020," Nov. 2017, https://www.itu.int/dms_pub/itu-r/opb/rep/R-REP-M.2411-2017-PDF-E.pdf

Student Questions

Spectrum for 5G

- ❑ World Radio-communications Conference (WRC) determines the spectrum requirements
- ❑ **WRC-2000** identified the spectrum required for 3G
- ❑ **WRC-2007** identified the spectrum required for 4G
- ❑ **WRC-2019** is expected to finalize spectrum required for 5G
- ❑ Two Frequency Ranges (FRs)
 - **FR1**: Sub 6-GHz. Several new bands in this range.
 - **FR2**: 24.25-52.6 GHz (mm-Waves)
 - ⇒ Good for high throughput in small cells
 - NR can use both paired and unpaired spectrum
NR specs list 26 operating bands for FR1 and 3 for FR2

Student Questions

Above 6 GHz

- ❑ **Free-space loss** increases in proportion to square of frequency and square of distance. 88 dB loss with 30 GHz at 20 m
⇒ 10-100 m cell radius
- ❑ **Outdoor-to-Indoor**: Glass windows add 20-40 dB
- ❑ **Mobility**: Doppler shift is proportional to frequency and velocity. Multipath results in varying Doppler shifts
⇒ Lower mobility
- ❑ **Wide Channels**: Duplex filters cover only 3-4% of center frequency ⇒ Need carrier aggregation.
- ❑ **Antenna**: 8x8 array at 60 GHz is only 2cm x 2cm. A/D and D/A converters per antenna element may be expensive
- ❑ 2 Gbps to 1 km is feasible using mm waves

Ref: ITU-R M2376-0, "Technical Feasibility of IMT in bands above 6 GHz," July 2015,
http://www.itu.int/dms_pub/itu-r/opb/rep/R-REP-M.2376-2015-PDF-E.pdf

Student Questions

Above 6 GHz (Cont)

- ❑ 100s MHz \Rightarrow **Multi-gigabit** data rates
- ❑ **Dense spatial reuse**
- ❑ Lower latency
- ❑ Need analog beamforming with narrow beam width
- ❑ **Adaptive beam steering** and switching to avoid blockage from hand, body, or foliage
- ❑ Need different antenna configurations in the mobile
- ❑ **Directional antennas** with adaptable 3D beamforming and beam tracking

Student Questions

5G Health Concerns

- ❑ 5G may need higher power transmission levels than those allowed currently by health regulations in various countries
- ❑ Federal Communications Commission (FCC) and International Commission on Non-Ionizing Radiation (ICNIRP)
 - Specify max *absorption rate* in W/Kg up to 6 GHz
 - Specify max *incident power* density W/m² for 6-10 GHz (absorption becomes difficult to measure in this range)
- ❑ 5G industry wants limits increased.
Health activists want limits decreased.
⇒ Current debate

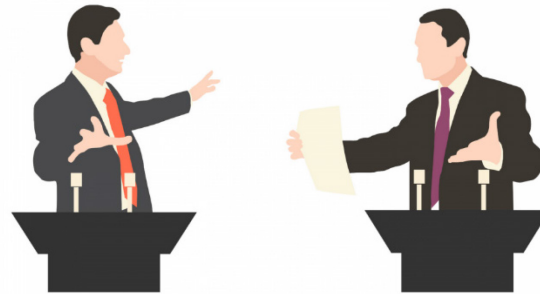

Student Questions

Ref: Radiationhealthrisks.com, "Why 5G Cell Towers Are More Dangerous,"
<https://www.radiationhealthrisks.com/5g-cell-towers-dangerous/>

3GPP Evolution from 4G to 5G

- ❑ **Rel. 8:** LTE. 4x4 MIMO, Flat Architecture, Low Latency, Multi-Band
 - ❑ **Rel. 9:** Evolved MultiMedia Broadcast Multicast Services (eMBMS), Voice over LTE (VoLTE), Femto Cells, Self-Organizing Network (SON)
- 3.9G
- ❑ **Rel. 10:** LTE-Advanced (4G). June 2011. Carrier aggregation, MIMO, Relays, Inter-Cell interference coordination
 - ❑ **Rel. 11:** March 2013. Coordinated Multipoint (CoMP) transmission, Enhanced carrier aggregation, New control channels, new mobile categories
 - ❑ **Rel. 12:** March 2015. Small Cells, Dual connectivity, Small-cell on/off, Semi-dynamic TDD, Direct device-to-device communication, simpler machine-type communications.
- 4G

Student Questions

3GPP Evolution from 4G to 5G (Cont)

- ❑ **Rel. 13:** LTE-Advanced Pro (4.5G). March 2016. License Assisted Access (LAA), Improved machine-type communications, carrier aggregation, device-to-device comm.
- ❑ **Rel. 14:** June 2017. Improved LAA, Vehicle-to-Everything (V2X), Wide-area broadcast with reduced subcarrier spacing
- ❑ **Rel. 15:** 5G Phase 1. Sep 2018. New Radio (NR), Non-Stand-Alone (NSA), Short TTI, ...
- ❑ **Rel. 16:** 5G Phase 2. mMTC, Stand-alone (SA)

Student Questions

3GPP Releases from 4G to 5G

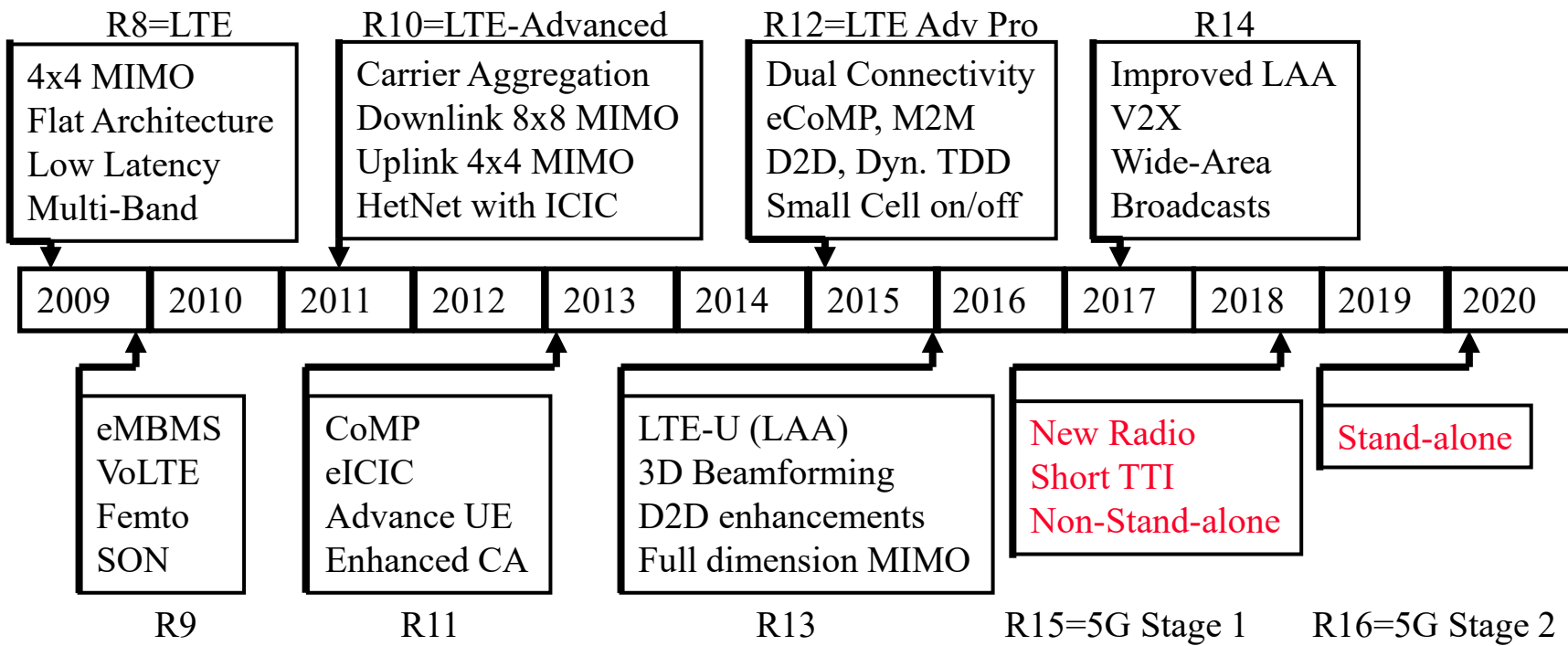

Student Questions

Ref: <https://portal.3gpp.org/#55934-releases>

Ref: H. Holma, A. Toskala, J. Reunanen, "LTE Small Cell Optimization," Wiley, 2016, ISBN: [9781118912577](https://doi.org/10.1002/9781118912577) (Not a Safari Book)

Washington University in St. Louis

<http://www.cse.wustl.edu/~jain/cse574-20/>

©2020 Raj Jain

3GPP 5G Proposal

- ❑ Rel. 8-9: LTE
- ❑ Rel. 10-12: LTE-Advanced
- ❑ Rel. 13-14: LTE Advanced-Pro
- ❑ Rel. 15: **New Radio** (NR), a.k.a., 5G NR.
- ❑ 3GPP specs are numbered TS xx.yyy, where xx is the series.
 - 36-series specs define LTE, LTE-Advanced, LTE-Advanced Pro
 - **38-series** specs define NR
- ❑ Note: NR has been submitted as a candidate for IMT-2020 in Feb. 2018. Has not passed the ITU evaluation yet. It is actually 5G Phase 1.
- ❑ Release 16 (5G Phase 2) will satisfy all IMT-2020 requirements.

Student Questions

Release 15 Features

- ❑ Scalable OFDM
- ❑ Supplementary Uplink
- ❑ Flexible Frame Structure
- ❑ Flexible Duplex Modes
- ❑ Efficient Channel Coding
- ❑ Low-Latency Features
- ❑ Optimized Massive MIMO
- ❑ Analog Beamforming
- ❑ Non-Standalone vs. Standalone Deployments
- ❑ Service Based Architecture
- ❑ Network Slicing
- ❑ Control-Plane User-Plane Split

Student Questions

Scalable OFDM

- ❑ Small subcarrier spacing \Rightarrow Large symbol time
 - \Rightarrow Allows large cyclic prefix
 - \Rightarrow Allows larger multipath delays (required at lower frequencies)
- ❑ Larger frequencies \Rightarrow Shorter ranges
 - \Rightarrow Shorter Cyclic Prefix OK \Rightarrow Shorter symbols
 - \Rightarrow Larger subcarrier spacing ok
- ❑ Increased phase noise at higher frequencies
 - \Rightarrow Larger subcarrier spacing required
- ❑ **Scalable OFDM**: Subcarrier spacing increases with the carrier frequency
 - 15 kHz or $2^n \times 15\text{kHz}$ \Rightarrow 15, 30, 60, 120 kHz
 - Max 3300 subcarriers \Rightarrow 50, 100, 200, 400 MHz band
- ❑ R15 allows 15/30/60 kHz spacing for FR1, 60/120 kHz for FR2

Student Questions

Scalable OFDM Numerology

15 kHz Spacing
< 3GHz,
Macro cells

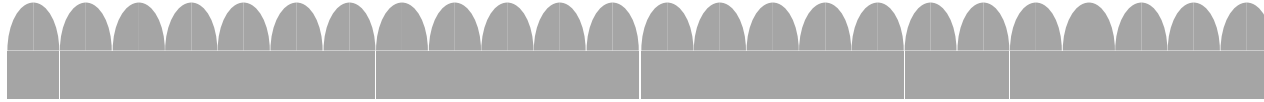

30 kHz Spacing
> 3 GHz
Small cells

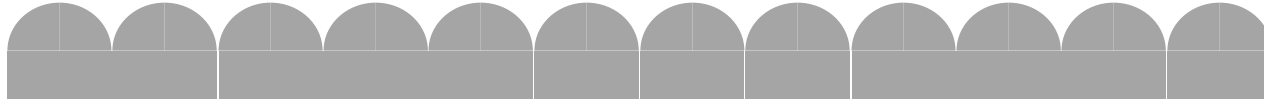

60 kHz Spacing
5 GHz Unlic.
Indoor



120 kHz Spacing
mmWave
Small Cells+Backhaul



Student Questions

Ref: G. Pfeifer, "5G Technology Introduction, Market Status Overview and Worldwide Trials," 5G and IoT Seminar, Italy, May 2017, https://cdn.rohde-schwarz.com/it/seminario/5G_Seminar_Part1_Standardization_Market_PHY_170509_Italy.pdf

Scalable OFDM Numerology (Cont)

Subcarrier Spacing (kHz)	15	30	60	15×2^n
Symbol Duration (μs)	66.67	33.33	16.67	$66.67/2^n$
Cyclic Prefix (μs)	4.69	2.34	1.17	$4.69/2^n$
Symbol + CP (μs)	71.35	35.68	27.84	$71.35/2^n$
Symbols/Slot	14	14	14	14
Slot Duration (μs)	1000	500	250	$1000/2^n$

- In NR: Max FFT size is higher (4098) and spectrum utilization is higher:

	LTE	5G NR	5G NR
Channel Width (MHz)	20	20	50
FFT Size	2048	2048	4096
Number of Subcarriers (15 kHz spacing)	1333	1333	3333
Occupied PRBs	100	106	270
Spectrum Utilization	90%	95.4%	97.2%

Ref: A. Zaidi, et al, "5G Physical Layer: Principles, Models and Technology Components," Academic Press, 2018,302 pp., ISBN: [9780128145784](https://doi.org/10.1016/B978-0-12-814578-4)

Student Questions

Supplementary Uplink

- ❑ Supplementary uplink (SUL) generally operates in a lower frequency band than the regular UL/DL
- ❑ SUL enhances the uplink rate in power limited situations where lower frequencies with lower path loss can extend uplink coverage
- ❑ Slightly different from carrier aggregation. Only uplink. No supplementary downlink.

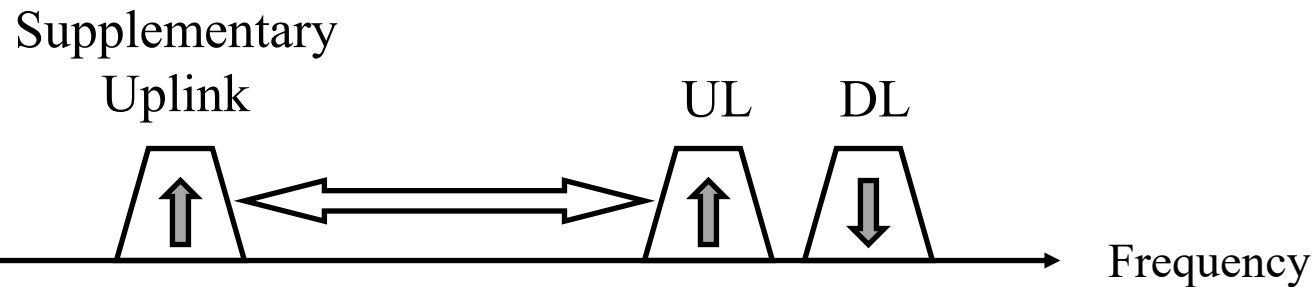

Student Questions

Frame Structure

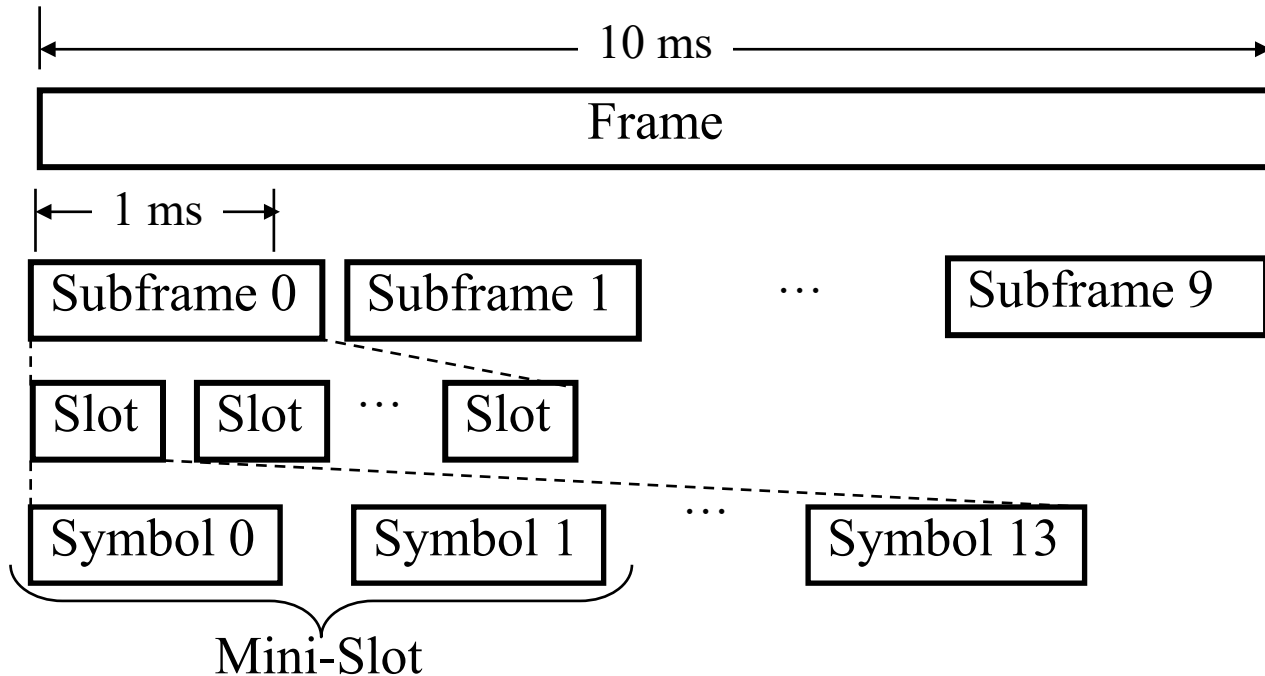

10 subframes/frame

Slots/subframe depends on subcarrier spacing.

symbols/slot depends on cyclic prefix: 12 or 14

A mini-slot consists of 2, 3 or 7 symbols

⇒ 2, 4, or 7 symbols/mini-slot

Subcarrier Spacing kHz	Slot Duration us	Slots per Subframe
15	1000	1
30	500	2
60	250	4
120	125	8
240	62.5	16

Student Questions

Resource Blocks

- ❑ In LTE: **Physical Resource Block** = 12 subcarriers x 6 or 7 symbols
- ❑ In 5G NR:
 - **Resource Element** = 1 subcarrier × 1 symbol
 - PRB = 12 subcarriers × 1 symbol

Assuming 15 kHz Subcarriers:

- **Time slot:** 1 ms = 14 OFDM symbols
- **Physical Resource Block:** 12 subcarriers (180 kHz) over 1 slot

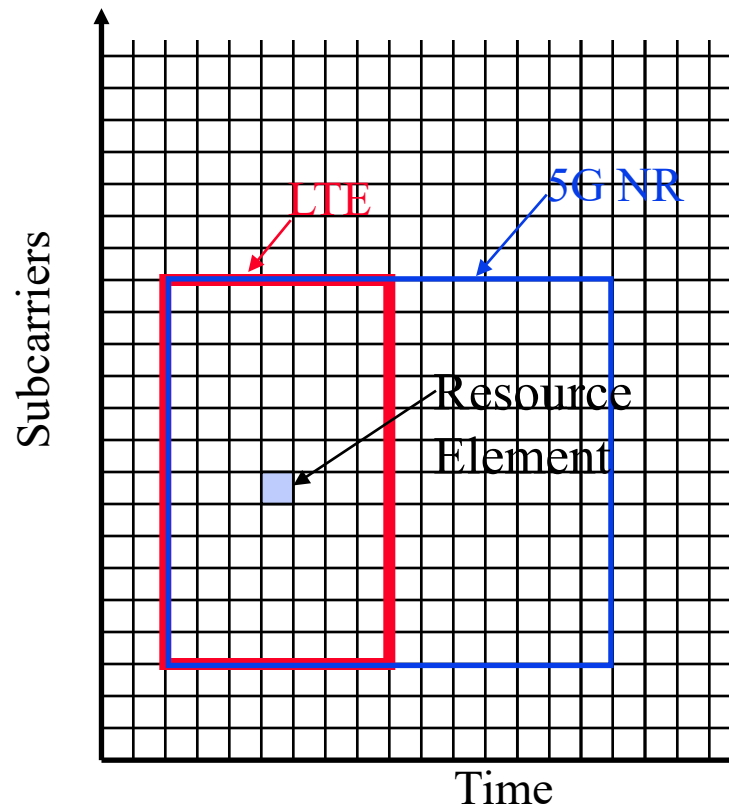

Student Questions

Bandwidth Parts (BWP)

- ❑ In LTE: All devices can transmit and receive the entire frequency band and use a fixed 15 kHz subcarrier spacing
- ❑ In 5G NR: A cell may have many subcarrier spacing and a device is not required to transmit/receive entire band
⇒ Time-Frequency grid is divided into bandwidth parts
- ❑ On each serving cell, at each time instant, there is one active downlink BWP and one uplink BWP
- ❑ After connection, a device can be configured with up to 4 downlink BWPs and 4 uplink BWPs for each serving cell
- ❑ In case of SUL operation, device can have up to 4 additional uplink BWPs

Student Questions

BWP Example

- ❑ For all subcarrier spacing
- ❑ PRB = 12 subcarriers × 14 symbols
- ❑ Smaller subcarrier spacing
⇒ Larger symbols
- ❑ Some bandwidth parts may not be active.
- ❑ NR supports carrier aggregation of 16 carriers
- ❑ Up to 256 QAM in DL and UL

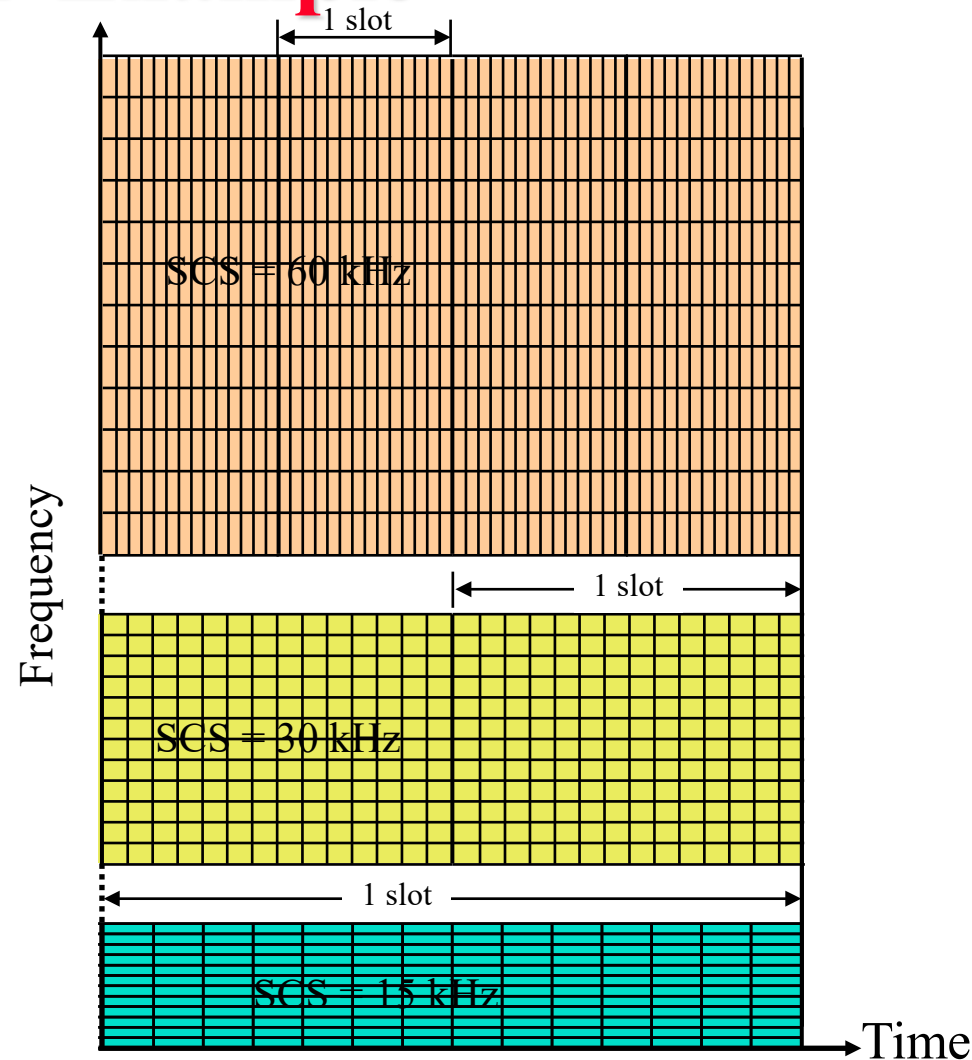

Student Questions

Ref: 5G Americas, "Wireless Technology Evolution - Transition from 4G to 5G, 3GPP Releases 14 to 16," Whitepaper, Oct 2018,
http://www.5gamericas.org/files/8015/4024/0611/3GPP_Rel_14-16_10.22-final_for_upload.pdf

Mini Slots

- ❑ At high-frequency, large bandwidth bands allows a large amount of data in a few symbols
- ❑ NR allows transmission over a fraction of a slot \Rightarrow Mini-slot
- ❑ 14 OFDM symbols per slot \Rightarrow 2, 4, or 7-symbols mini-slots
- ❑ URLLC traffic use mini-slots and can pre-empt eMBB traffic \Rightarrow Very low latency. Pre-empted user recovers using HARQ
- ❑ Slot aggregation for high-data rate eMBB

Student Questions

Ref: Qualcomm, "Designing 5G NR - The 3GPP Release 15 global standard for a unified, more capable 5G air interface," Sep 2018, 37 pp., <https://www.qualcomm.com/media/documents/files/the-3gpp-release-15-5g-nr-design.pdf>

Flexible Slots

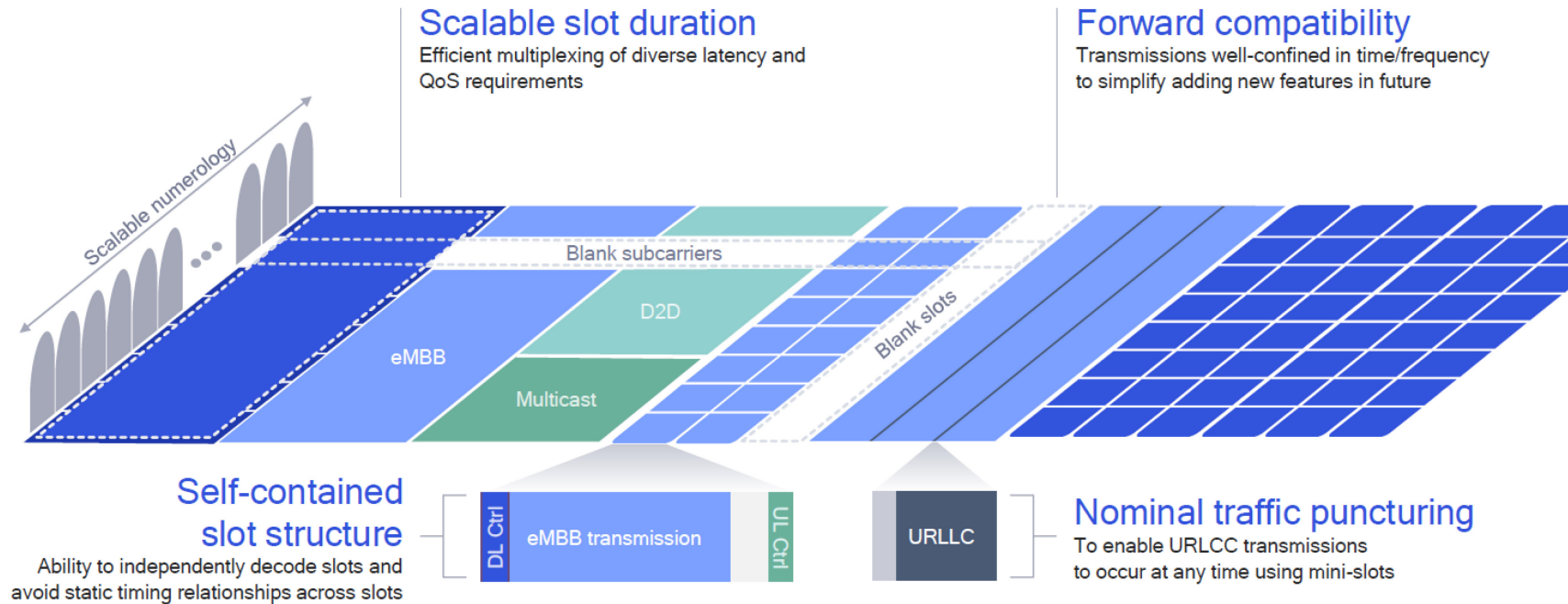

Student Questions

Ref: Qualcomm, "Designing 5G NR - The 3GPP Release 15 global standard for a unified, more capable 5G air interface," Sep 2018, 37 pp., <https://www.qualcomm.com/media/documents/files/the-3gpp-release-15-5g-nr-design.pdf>

Duplex Modes

- ❑ FDD: Different transmission directions on either part of a paired spectrum
- ❑ NR allows one common frame structure over both paired and unpaired spectra
- ❑ Allows both half and full duplex operation:
 - Half-duplex FDD
 - TDD (half-duplex by definition)
 - Full-duplex FDD
- ❑ Inter-cell interference due to TDD is less in small cells
 - ⇒ **Dynamic TDD**
 - ⇒ UL/DL directions can be dynamically assigned on a slot basis

Allows handling larger variation of traffic due to smaller number of users in small cells

Student Questions

TDD Slot Structure Examples

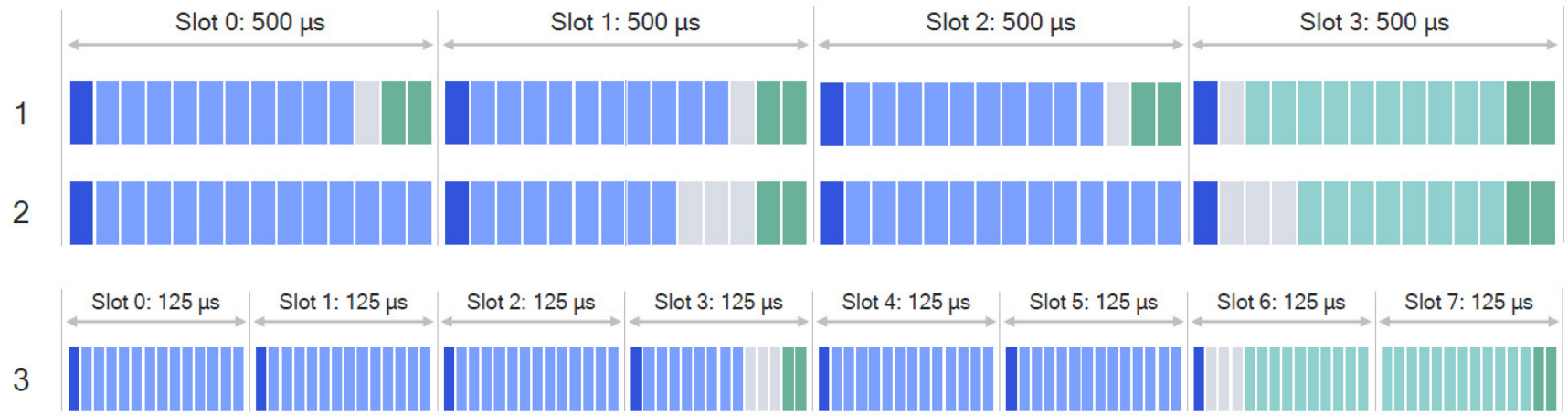
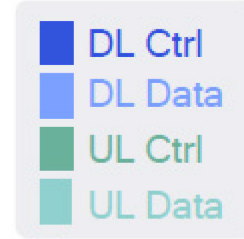

DL reference signals (DL DMRS) & UL Reference + Sounding (UL DSMR, SRS) not showed for simplicity

- | | | |
|---|--|---|
| <p>1. Indoor (sub-6 or mmWave)</p> <ul style="list-style-type: none"> • Shorter guard for indoor deployment • Fast turn-around (DL/UL switch per slot) • Ultra-low latency possible on every slot • Maximum flexibility for UL/DL allocation | <p>2. Outdoor (sub-6 or mmWave)</p> <ul style="list-style-type: none"> • Larger guard for outdoor deployment • DL/UL switch per 1ms (5x faster than LTE) • Slot 1 opportunity for ultra-low latency • Bulk of UL traffic goes on Slot 3 | <p>3. Outdoor mmWave</p> <ul style="list-style-type: none"> • Larger guard for outdoor deployment • 6:2 configuration every 1ms (120kHz SCS) • Slot 3 opportunity for ultra-low latency • Bulk of UL traffic goes on Slots 6 & 7 |
|---|--|---|

Student Questions

Ref: Qualcomm, "Designing 5G NR - The 3GPP Release 15 global standard for a unified, more capable 5G air interface," Sep 2018, 37 pp., <https://www.qualcomm.com/media/documents/files/the-3gpp-release-15-5g-nr-design.pdf>

Duplex Mode Examples

DL-Heavy with UL

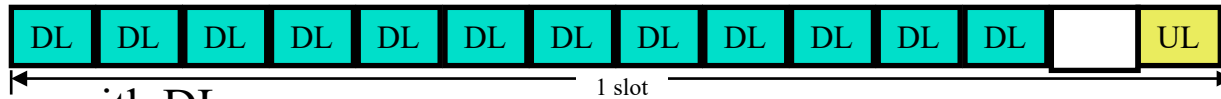

UL-Heavy with DL



DL only with late start due to relaxed synchronization



Using mini-slots for URLLC



Slot aggregation for DL (eMBB)



Slot aggregation for UL (eMBB)

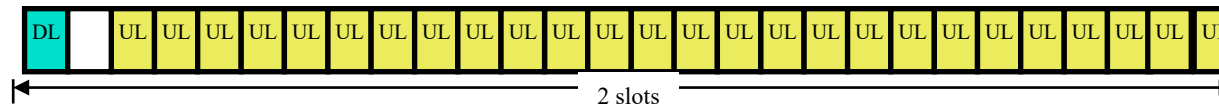

Student Questions

Ref: A. Zaidi, et al, "5G Physical Layer: Principles, Models and Technology Components," Academic Press, 2018,302 pp., ISBN: [9780128145784](https://doi.org/10.1016/B978-0-12-814578-4)

Reference Signals

- ❑ Used to access channel quality like pilot subcarriers
- ❑ **Demodulation Reference Signal (DM-RS)**: Estimate channel for demodulation. Placed at the beginning of slot.
- ❑ **Phase Tracking Reference Signal (PT-RS)**: Estimate phase noise at high carrier frequencies
- ❑ **Channel State Information Reference Signal (CSI-RS)**: Beam management and uplink power control
- ❑ **Sounding Reference Signal (SRS)**: Transmitted in uplink to measure channel for scheduling and link adaptation

Student Questions

Reference Signals (Cont)

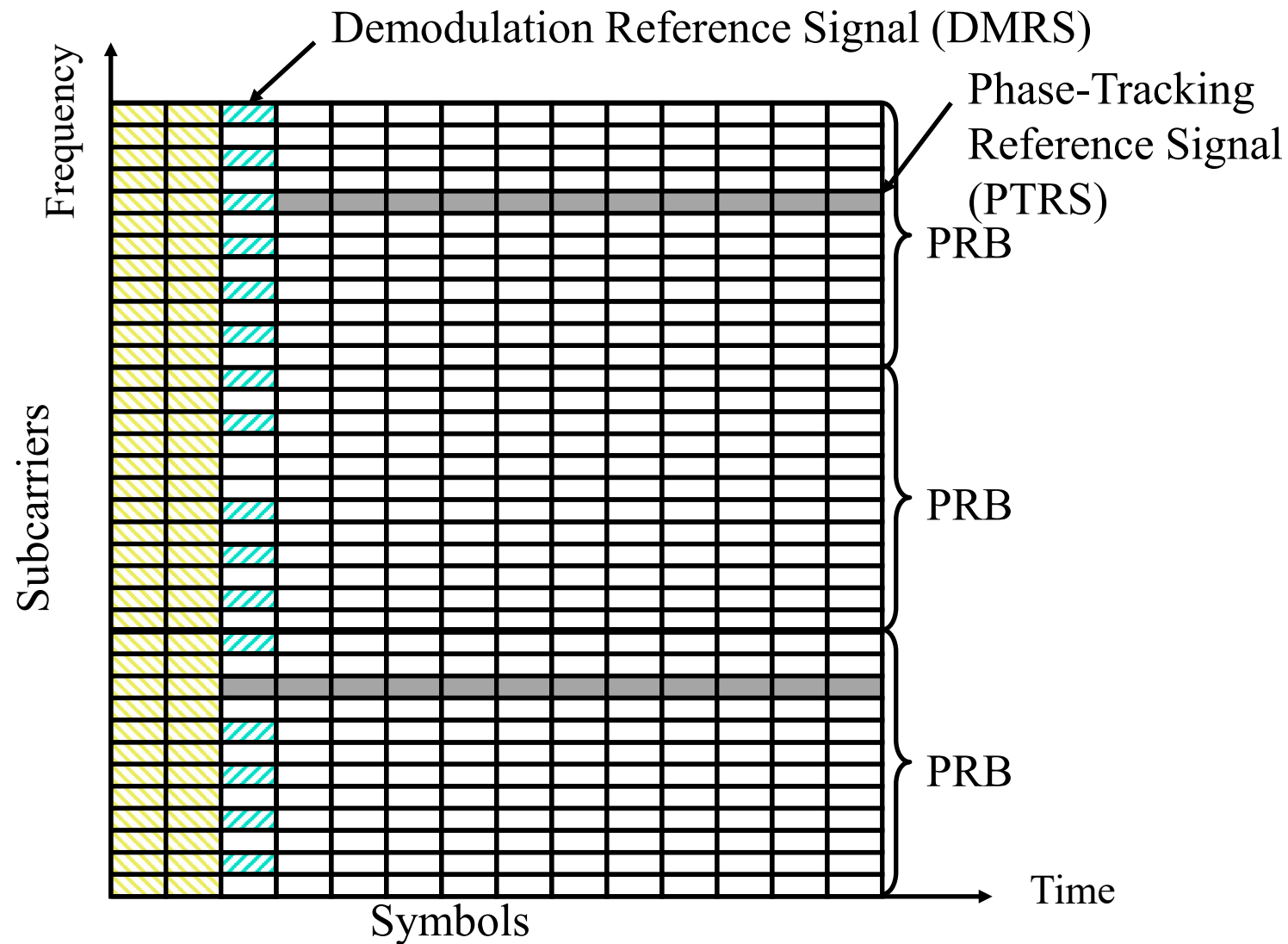

Student Questions

Control Channels

- ❑ Control channels are used for scheduling requests, grants, HARQ acks, Channel state feedback, etc.
- ❑ Several Physical Downlink Control Channels (PDCCH) and Physical Uplink Control Channels (PUCCH)
- ❑ PDCCHs occupy only a part of the carrier bandwidth (LTE uses full bandwidth for control)
⇒ Allows narrow-band devices do not need to listen to whole bandwidth
- ❑ Each control channel has its own reference signals
⇒ Allows beamforming of control channels
- ❑ Short PUCCH can be transmitted in the same slot

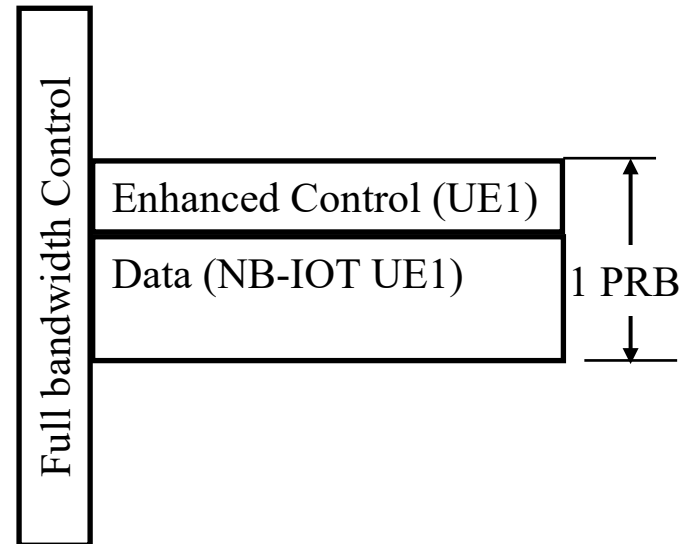

Student Questions

Channel Coding

- ❑ Multi-Edge Low Density Parity Check Code for Data:
 - A.k.a. Quasi-Cyclic LDPC
 - Less complex than LTE Turbo codes
 - ⇒ Good for high data rates
- ❑ Polar Code for Control
 - Better performance for small data in control channel
 - Uses CRC for joint detection and decoding

Student Questions

Ref: T. Richardson, R. Urbanke, "Multi-Edge Type LDPC Codes," 36 pp., <http://wiiu4.free.fr/pdf/Multi-Edge%20Type%20LDPC%20Codes.pdf>

Ref: V. Bioglio, C. Condo, I. Land, "Design of Polar Codes in 5G New Radio," 9 pp., 12 Apr 2018, <https://arxiv.org/pdf/1804.04389>

Low-Latency Features

- ❑ Front-loaded reference signals and control signaling.
⇒ Device can start processing the control immediately without inter-leaving in time as in LTE.
- ❑ Mini-Slots:
 - Device can respond with HARQ ack within one slot
 - Device can upload data within one slot of grant
- ❑ MAC and RLC are designed so that device can start processing data without knowing the total data
- ❑ Pre-emption may results in missing symbols
HARQ retransmits only missing code-block groups (CBG)
- ❑ Device can be configured to transmit/receive without going through request-grant-transmit sequence.

Student Questions

Optimized Massive MIMO

- ❑ Massive MIMO: Large number of steerable antenna elements
 - Necessary for beamforming in higher bands
 - Used for spatial multiplexing in lower bands
- ❑ NR channels and signals designed to support beamforming
- ❑ Assuming channel reciprocity, UL Sounding reference signal (SRS) can be used for DL in TDD

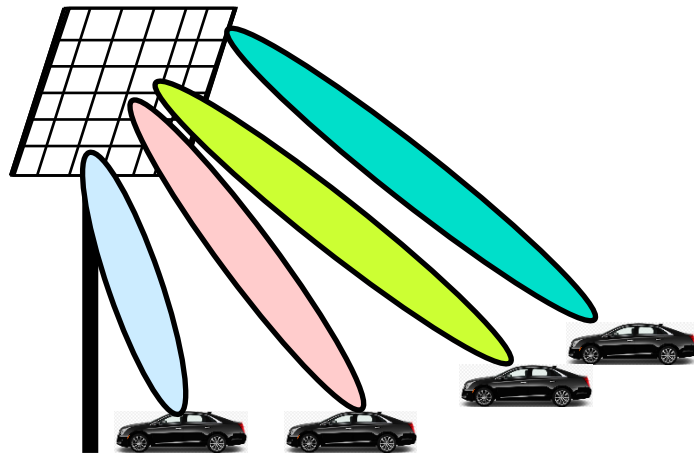

Student Questions

Optimized Massive MIMO (Cont)

- ❑ High-resolution Channel State Information (CSI) RS design and reporting
- ❑ High-spatial resolution codebook supporting up to 256 antennas
- ❑ 12 Orthogonal demodulation reference signals specified for multi-user MIMO
- ❑ Phase-tracking reference signals are used to overcome increased phase noise at higher frequencies (otherwise higher constellation QAMs, e.g., 64-QAM, cannot be used)
- ❑ Massive MIMO with high-power user equipment (HPUE)
⇒ 3× to 4× more throughput

Student Questions

Distributed MIMO

- ❑ A device can receive multiple data channels per slot from different sites
- ❑ Some MIMO layers are transmitted from one site and others from another site
- ❑ Allows simultaneous data transmissions from multiple sites
- ❑ Not complete in R15

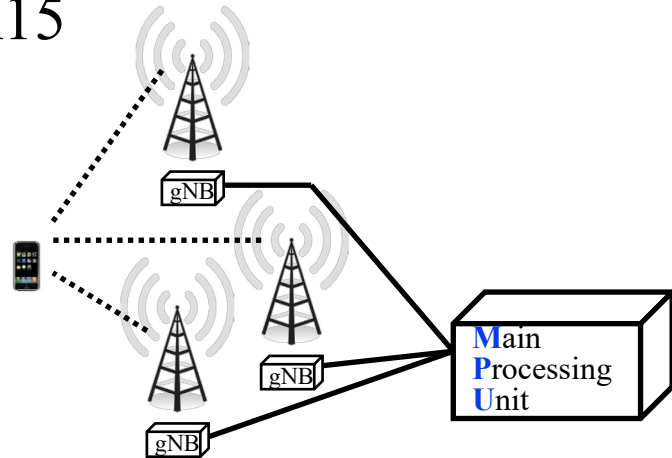

Ref: W. Peng, et al, "Outage and Capacity Performance Evaluation of Distributed MIMO Systems over a Composite Fading Channel," Mathematical Problems in Engineering 2014, September 2014, 13 pp.,

https://www.researchgate.net/publication/285571817_Outage_and_Capacity_Performance_Evaluation_of_Distributed_MIMO_Systems_over_a_Composite_Fading_Channel

Student Questions

Beamforming

- ❑ In mmWave, beamforming is required
- ❑ Beam management procedures include beam determination, measurement, reporting and sweeping
- ❑ Beam recovery procedures include beam failure detection, notification, and recovery request
- ❑ Beam management requires 3 step refinements: coarse, medium, and narrow beams

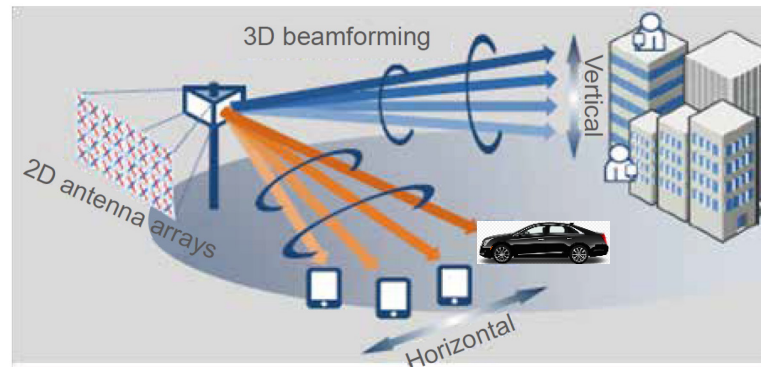

Ref: ZTE, "Pre5G: Building the Bridge to 5G," White Paper, June 2, 2017, 20 pp.,

<http://www.zte-deutschland.de/pub/endata/magazine/ztetechnologies/2017/no3/201705/P020170516552408246119.pdf>

Washington University in St. Louis

<http://www.cse.wustl.edu/~jain/cse574-20/>

©2020 Raj Jain

Student Questions

Analog Beamforming

- ❑ Beam is sent after digital-to-analog conversion
- ❑ Required at high frequencies
- ❑ Analog beam can be sent only in one direction at one time
- ❑ Beam sweeping:
 - Send the same signal in other directions in other symbols
 - Allows reaching the entire coverage area

Student Questions

Code Block Group (CBG)

- ❑ Larger transport blocks are segmented into multiple **code block groups (CBG)**.
- ❑ Each **code block** has a CRC
- ❑ Entire transport block has a cyclic redundancy check (CRC)
- ❑ If a code block fails CRC, the entire code block group is retransmitted
- ❑ HARQ feedback has a bit for each CBG to indicate whether to retransmit that CBG or not.

Student Questions

Non-Standalone vs. Standalone Deployments

- ❑ 5G = 5G RAN + 5G Core
- ❑ Core is responsible for non-radio functions: authentication, charging, end-to-end connections, paging
- ❑ **Non-Standalone (NSA)**: Use legacy EPC core w 5G RAN
⇒ Help accelerate 5G NR deployments
- ❑ **Standalone (SA)**: Full 5G RAN + 5G Core

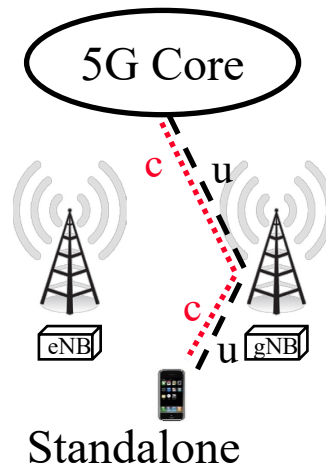
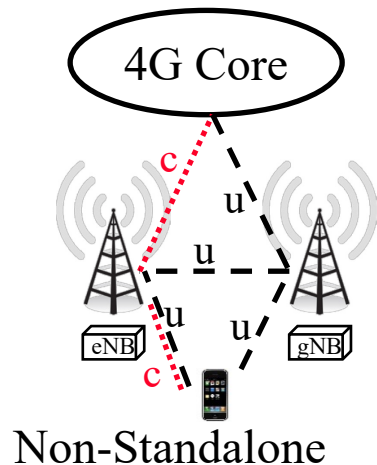

c = control plane
u = user plane

Student Questions

NSA Options

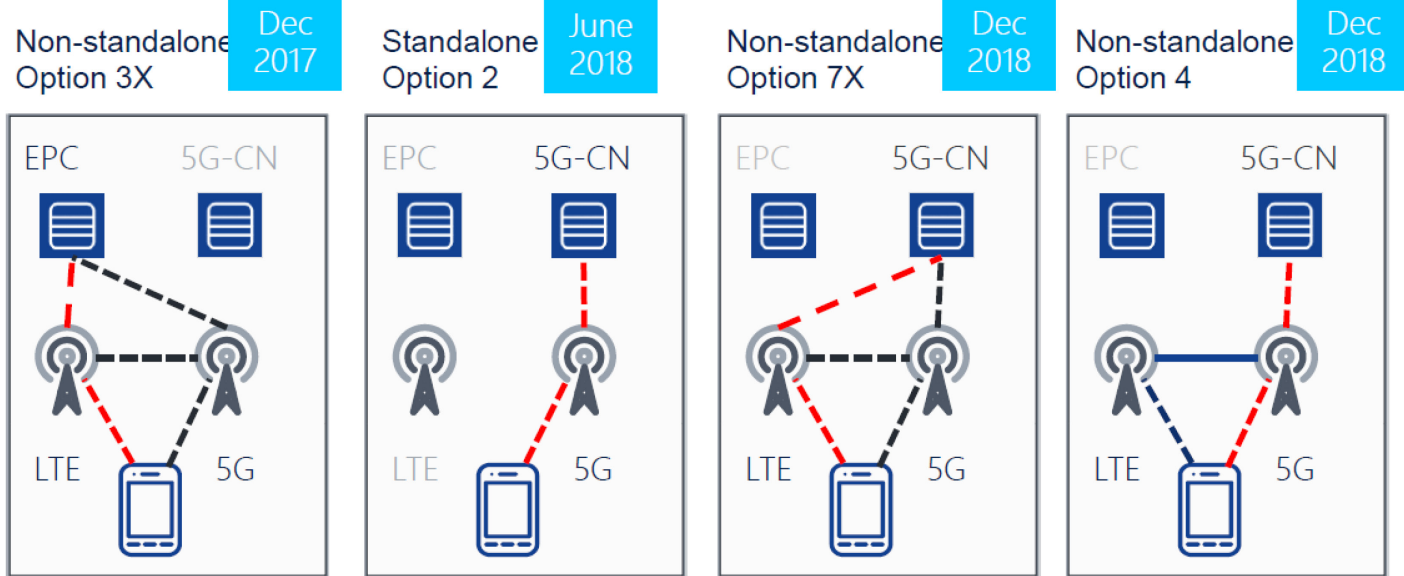

Option 5 = LTE connected
To 5G core (Known also as eLTE)

- - - = Control plane only
 - - - = User + control plane
 - - - = User plane only

In 2Q/2018 focus on options 2 and 3, options 4 and 7 to be introduced as Release 15 late drop 12/18 (ASN.1 03/19)

Student Questions

Ref: A. Toskala, "5G Standards and Outlook for 5G Unlicensed," June 2018,
https://www.multefire.org/wp-content/uploads/5G_Standard_Toskala_MUulteFire-Open-Day-Meeting.pdf

Washington University in St. Louis

<http://www.cse.wustl.edu/~jain/cse574-20/>

©2020 Raj Jain

5G Core Network

- ❑ Service Based Architecture
- ❑ Network Slicing
- ❑ Control-Plane/User-Plane Split

Student Questions

Service Based Architecture

- Each service is a function and several functions can be implemented in a physical node or a virtual machine

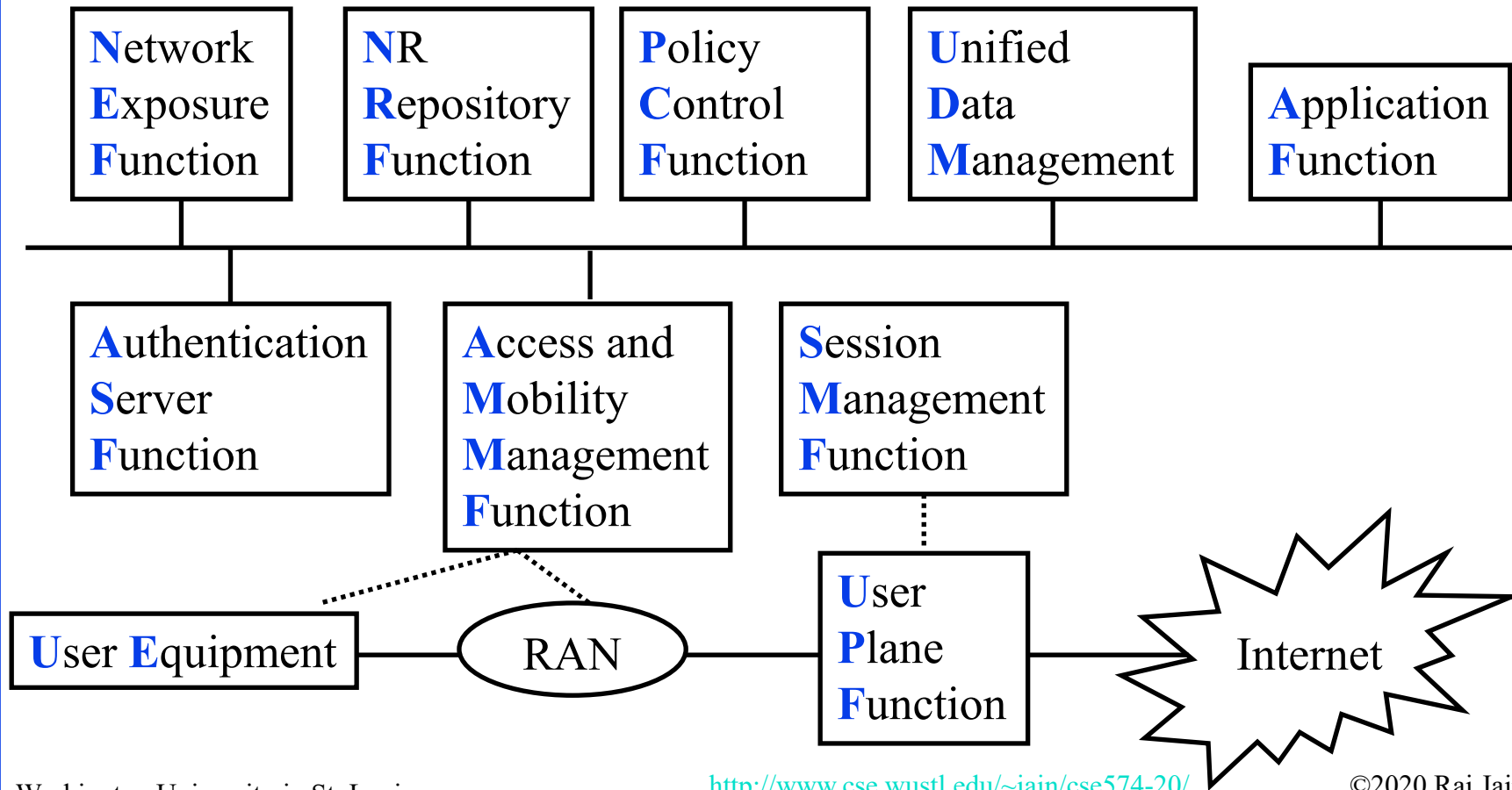

Student Questions

Network Slicing

- ❑ Slice = A **logical** network serving a particular application, business partner, or customer
- ❑ Similar to Virtual Machines (VMs) on a computer
- ❑ A network can be divided in to many slices
- ❑ Each slice looks to the user as a separate network with reserved resources reserved

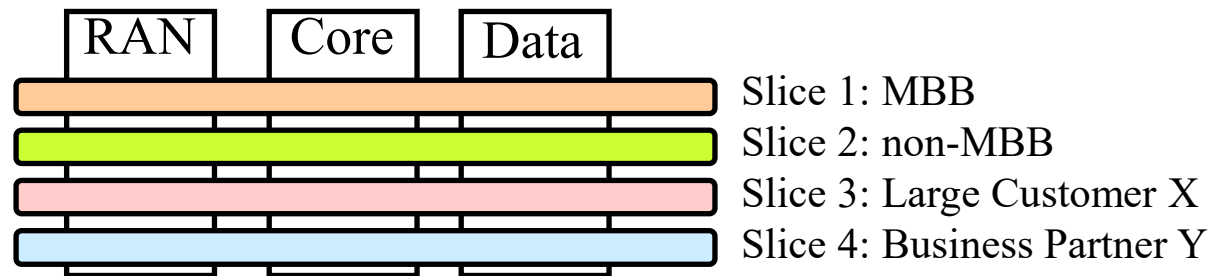

Ref: E. Guttman, "5G New Radio and System Standardization in 3GPP,"

https://www.itu.int/en/ITU-T/Workshops-and-Seminars/201707/Documents/Eric_Guttman_5G%20New%20Radio%20and%20System%20Standardization%20in%203GPP.pdf

Washington University in St. Louis

<http://www.cse.wustl.edu/~jain/cse574-20/>

©2020 Raj Jain

Student Questions

Control-Plane User-Plane Split

- ❑ Control: Session management, IP address allocation, signaling between core and device, authentication, security, mobility,
- ❑ User: Packet routing and forwarding, packet filtering, packet inspection, quality of service
- ❑ Control-plane and user-plane interfaces are separate.
- ❑ For example: A node with dual connectivity. Control through LTE and data split between LTE and 5G

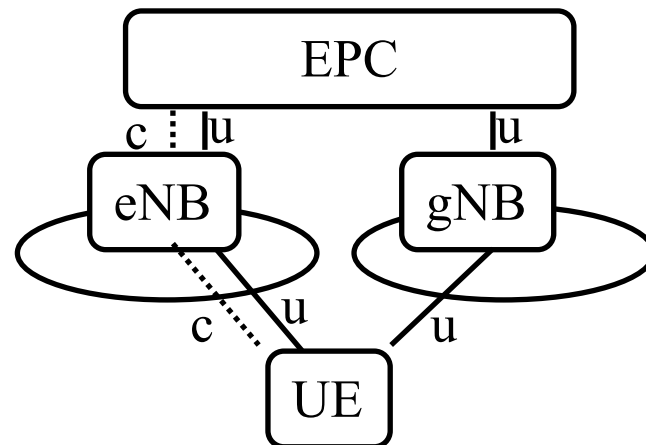

Student Questions

User-Plane RAN Protocol Stack

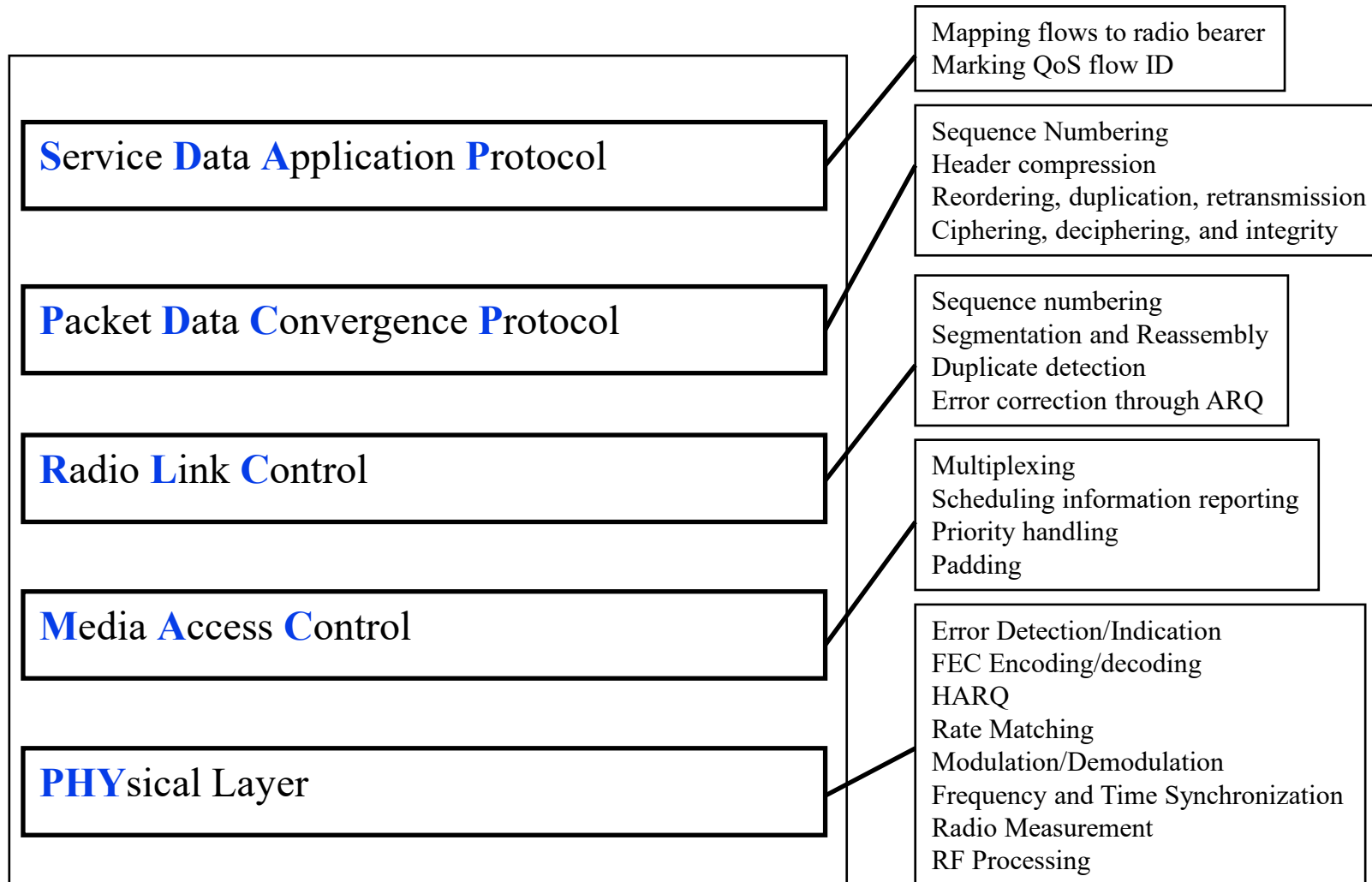

Student Questions

Control-Plane RAN Protocol Stack

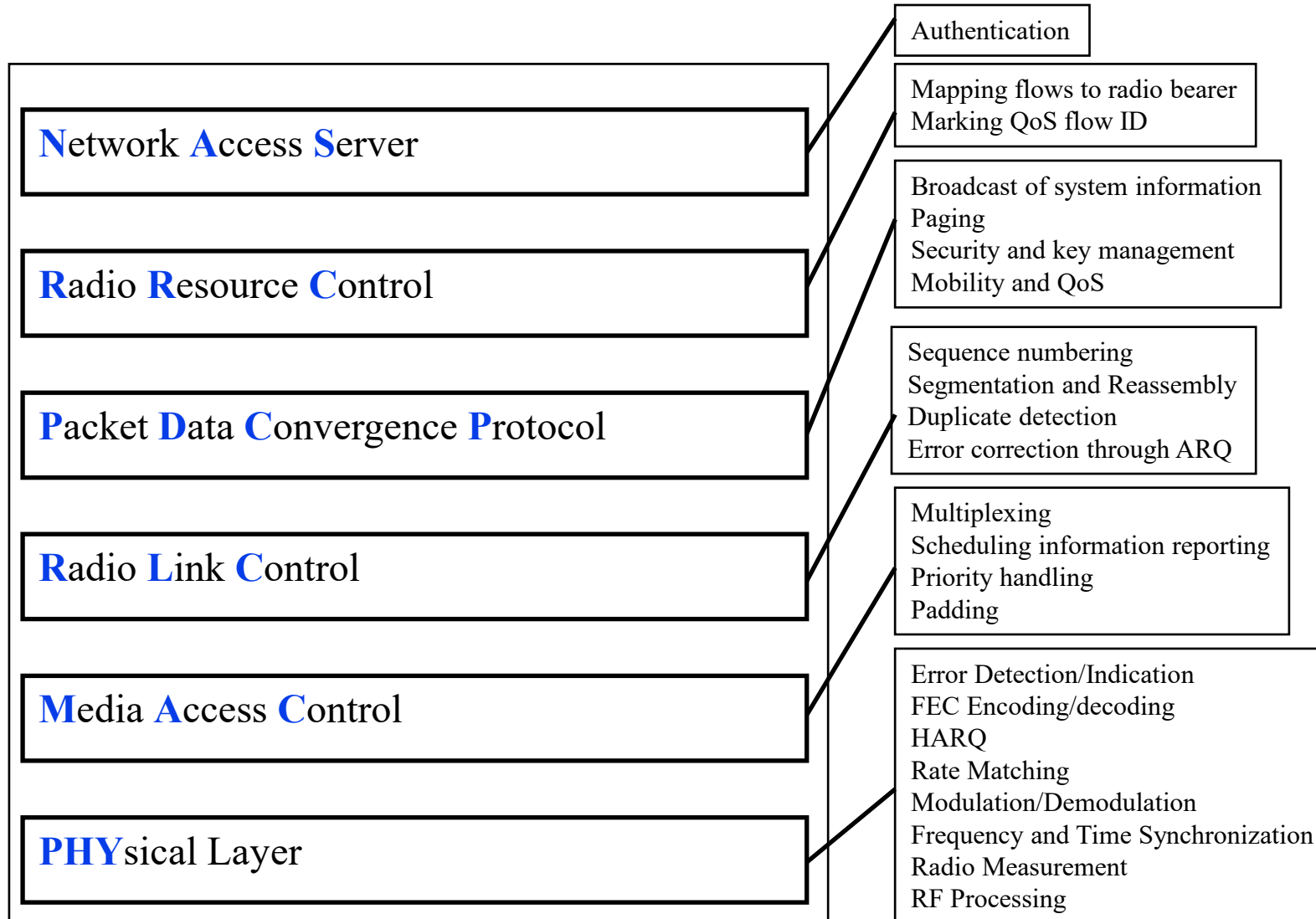

Student Questions

Network Evolutions

- ❑ Cloud-Radio Access Network (**C-RAN**)
 - Centralized radio processing
 - Minimizes changes to RAN for 5G and future evolutions
- ❑ Mobile Edge Computing (**MEC**)
 - Distributed core
 - Helps reduce latency

Student Questions

Cloud Radio Access Network (C-RAN)

- ❑ Centralize baseband processing in a cloud
- ❑ Need to carry high-bit rate signal (after A-to-D conversion) from tower to cloud site ~ 10 Gbps
- ❑ Optical fiber, 10 Gbps Ethernet, Microwave can be used depending upon the distance ~ 1-20 km of **front haul**
- ❑ Particularly good for dense small cells. Multi-provider support.

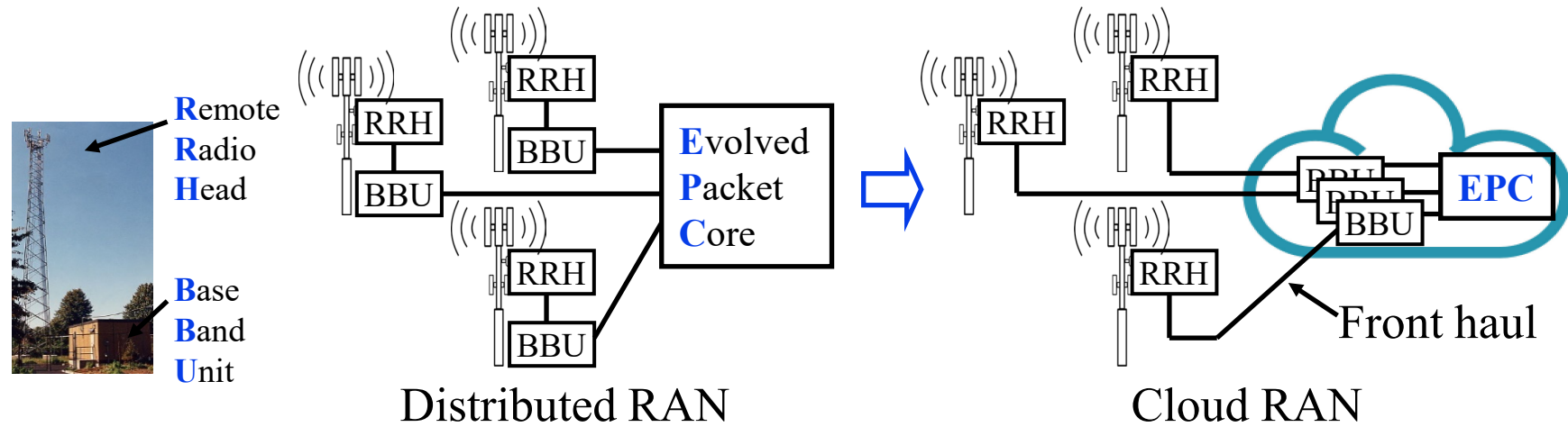

Student Questions

Ref: C. I, et al, "Recent Progress on C-RAN Centralization and Cloudification," IEEE Access, Vol. 2, 2014, pp. 1030-1039,
<http://ieeexplore.ieee.org/iel7/6287639/6514899/06882182.pdf?arnumber=6882182>

Mobile Edge Computing (MEC)

- To service mobile users/IoT, the computation needs to come to edge \Rightarrow Mobile Edge Computing

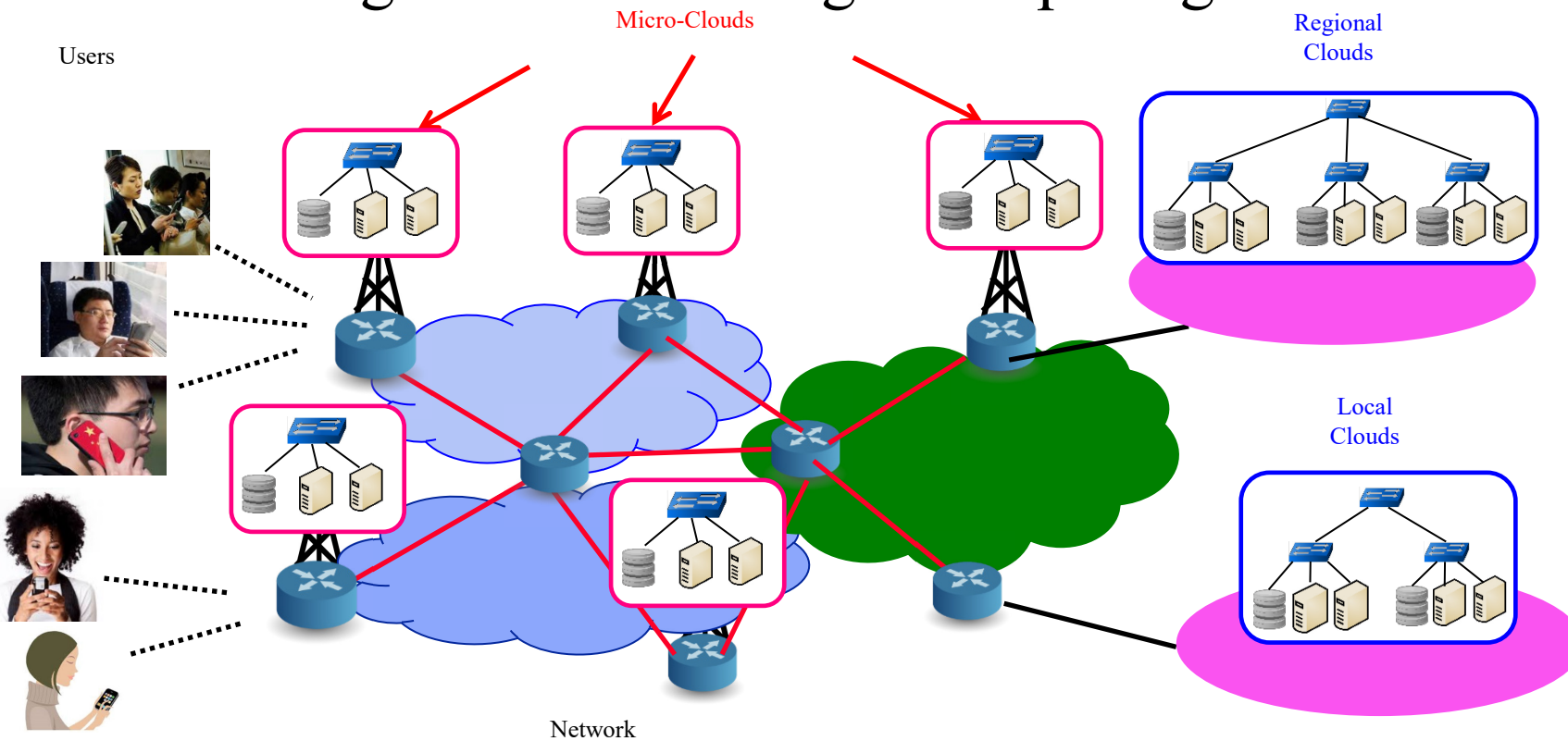

Ref: L. Gupta, R. Jain, H. Chan, "Mobile Edge Computing - an important ingredient of 5G Networks," IEEE Softwarization Newsletter, March 2016, <http://sdn.ieee.org/newsletter/march-2016/mobile-edge-computing-an-important-ingredient-of-5g-networks>

Student Questions

Network Function Virtualization

- ❑ Standard hardware is fast and cheap \Rightarrow No specialized hardware
- ❑ Implement all functions in software
- ❑ Virtualize all functions \Rightarrow Cloud \Rightarrow Create capacity on demand

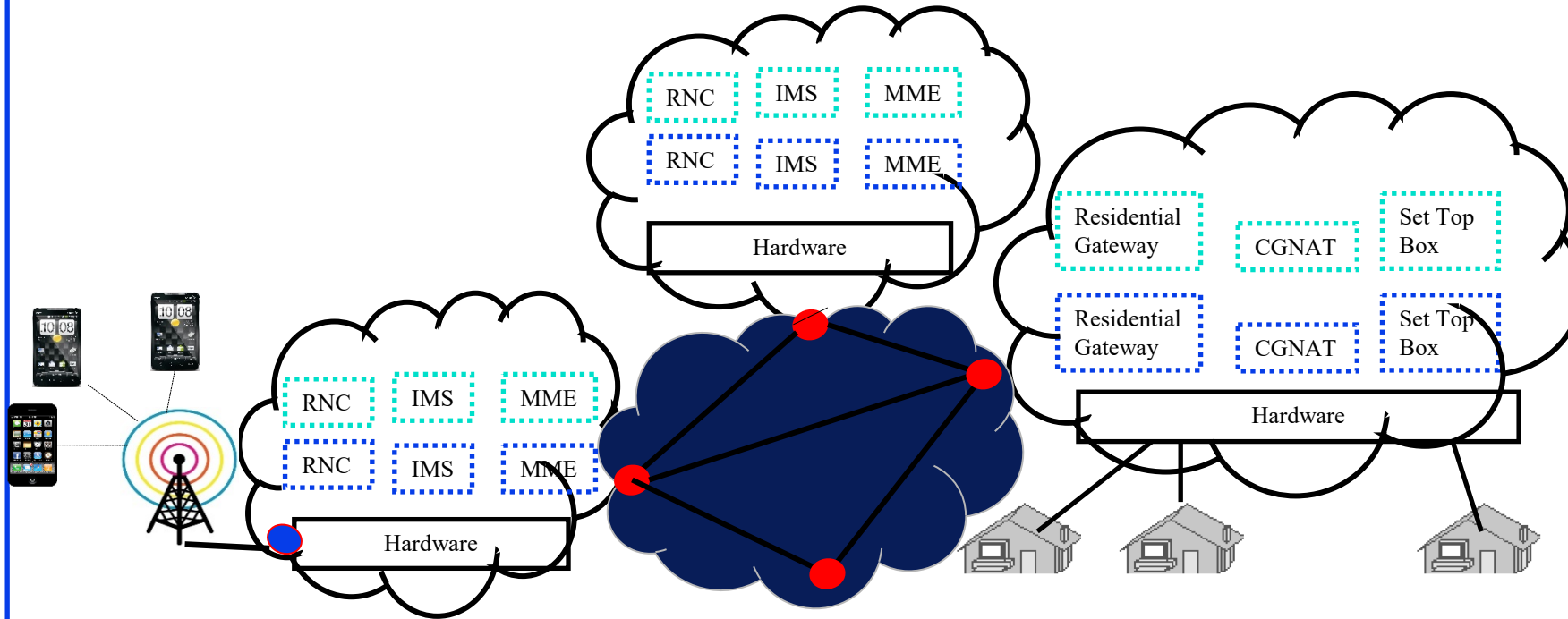

Ref: Raj Jain, "SDN and NFV: Facts, Extensions, and Carrier Opportunities," AT&T Labs SDN Forum Seminar, April 10, 2014,
http://www.cse.wustl.edu/~jain/papers/adn_att.htm

Student Questions

5G Trials

- ❑ Many operators have announced 5G trials
Verizon, SK Telecom, Korea Telecom, NTT DoCoMo, AT&T, China Mobile, ...
- ❑ Pre-Standard 5G.
- ❑ Most are using sub-6GHz spectrum
- ❑ Mostly enhanced Mobile Broadband (eMBB) and Fixed Wireless Access (FWA)

Student Questions

3G vs. 4G vs. 5G

	3G	4G	5G
DL Waveform	CDMA	OFDMA	OFDMA,SCFDMA
UL Waveform	CDMA	SCFDMA	OFDMA,SCFDMA
Channel Coding	Turbo	Turbo	LDPC (Data)/Polar (Control)
Beamforming	No	Data only	Full support
Spectrum	0.8-2.1 GHz	0.4-6 GHZ	0.4-52.6 GHz
Bandwidth	5 MHz	1.4-20 MHz	Up to 400 MHz
Network Slicing	No	No	Yes
QoS	Bearer based	Bearer based	Flow based
Small Packet Support	No	No	Connectionless
Cloud Support	No	No	Yes

Student Questions

Ref: A. Toskala, "5G Standards and Outlook for 5G Unlicensed," June 2018,
https://www.multefire.org/wp-content/uploads/5G_Standard_Toskala_MUulteFire-Open-Day-Meeting.pdf
<http://www.cse.wustl.edu/~jain/cse574-20/>
 Washington University in St. Louis

©2020 Raj Jain

Release 16 Timeline

- ❑ No major changes are done after a release is frozen.
- ❑ Abstract Syntax Notation One (ASN.1) is the notation used to specify message formats in the final specifications.
- ❑ Release 15 had 3 stages: Non-standalone (NSA), Standalone (SA), and Late Drop.

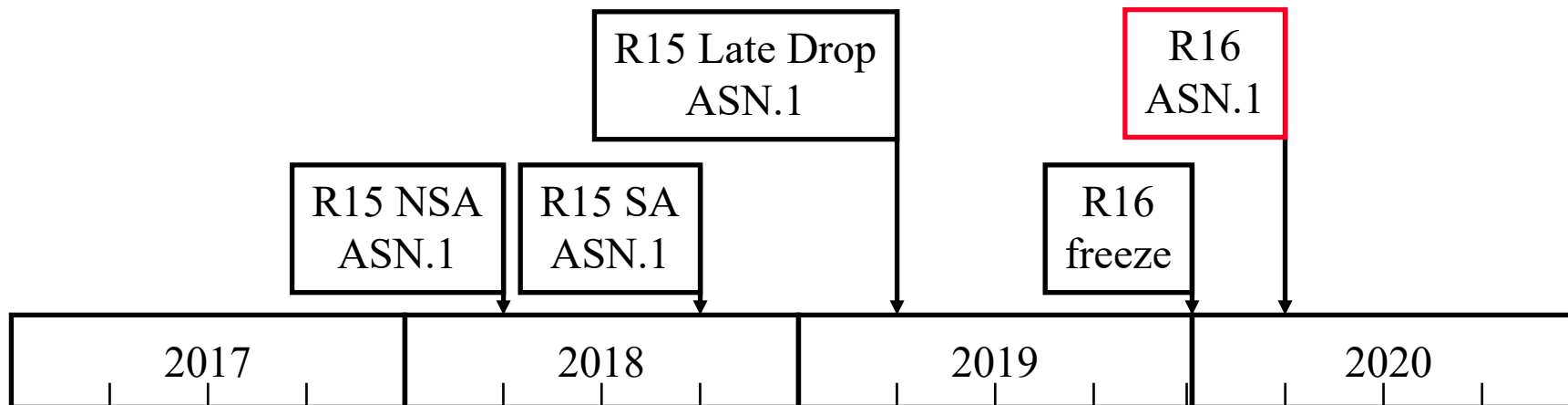

Ref: A. Toskala, "5G Standards and Outlook for 5G Unlicensed," June 2018,
https://www.multefire.org/wp-content/uploads/5G_Standard_Toskala_MUulteFire-Open-Day-Meeting.pdf
Washington University in St. Louis <http://www.cse.wustl.edu/~jain/cse574-20/>

©2020 Raj Jain

Student Questions

Release 16 Work Items

- ❑ **NR V2X**
- ❑ **Non-Terrestrial Networks**
- ❑ **Above 52.6 GHz**
- ❑ **Integrated Access and Backhaul (IAB)**
- ❑ **IoT Techniques**
- ❑ **Private 5G Networks for Industrial IoT**
- ❑ **Enhancements to:**
 - Positioning
 - MIMO Enhancements
 - Power Saving
 - Interference
 - Data Collection and Utilization
 - Network Automation
 - Mobility Enhancements
 - Carrier Aggregation and Dual Connectivity
 - Access to Unlicensed Spectrum
 - Conversational Services
 - Wireless-Wire line Convergence

Student Questions

Ref: 5G Americas, "Wireless Technology Evolution - Transition from 4G to 5G, 3GPP Releases 14 to 16," Whitepaper, Oct 2018,
http://www.5gamericas.org/files/8015/4024/0611/3GPP_Rel_14-16_10.22-final_for_upload.pdf

NR V2X

❑ Vehicle Platooning:

- Dynamically form platoon travelling together
- All vehicles get information from the leading vehicle

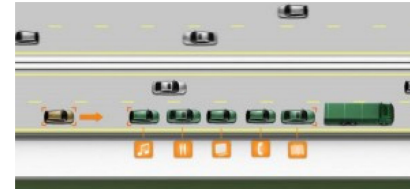

❑ Extended Sensors:

- Sharing data/video from sensors with other vehicles, road-side units, pedestrians, and application servers
- Allows vehicles to get a more global view of the environment and Intention sharing
- Evolve for autonomous driving
- Need high data rate

❑ Remote Driving:

- Driving in dangerous areas or driving for those unable to drive
- Public transports train/metro driving
- Need high reliability and low latency
- High-throughput sensor sharing

Student Questions

Ref: Qualcomm, "Expanding the 5G NR ecosystem and roadmap in 3GPP Release 16 and beyond," Sep 2018, 35 pp.,

<https://www.qualcomm.com/media/documents/files/expanding-the-5g-nr-ecosystem-and-roadmap-in-3gpp-rel-16-beyond.pdf>

Washington University in St. Louis

<http://www.cse.wustl.edu/~jain/cse574-20/>

©2020 Raj Jain

Non-Terrestrial Networks

- ❑ Satellite use with 5G will allow continuity of coverage
- ❑ Unmanned aircrafts as cell towers
- ❑ Not high throughput. For continuity of coverage
- ❑ Need to make PHY retransmission procedures more delay tolerant
- ❑ Study effect of propagation delays
 - Low-Earth Orbit (LEO),
Geo-stationary (GEO)
- ❑ Handover and paging

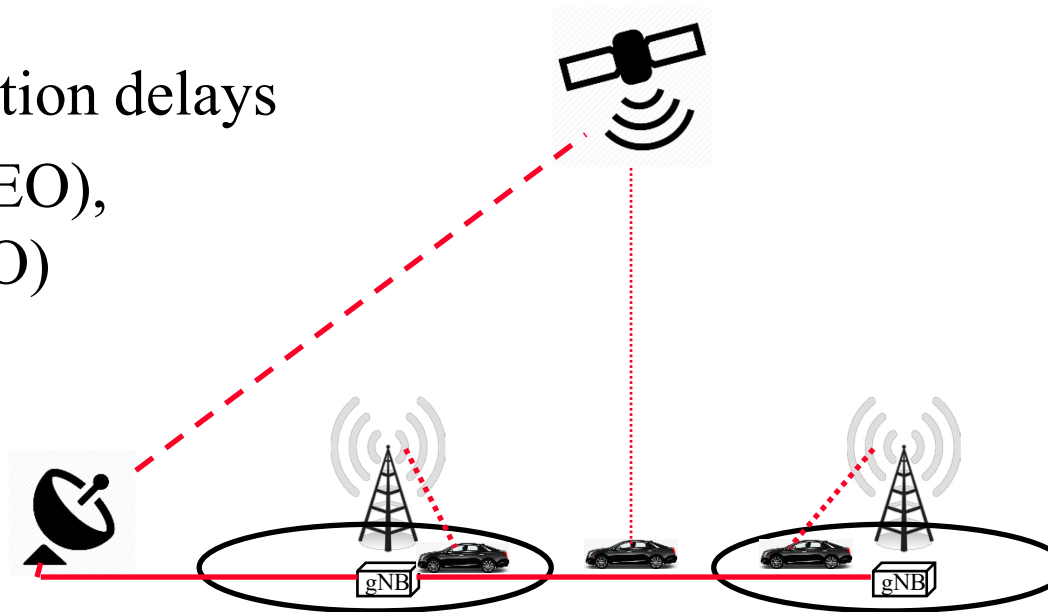

Student Questions

Above 52.6 GHz

- ❑ R15 designed to use up to 52.6 GHz
- ❑ Higher Frequencies:
 - Higher phase noise
 - Extreme propagation loss
 - Lower power amplifier efficiency
 - Stricter power spectral density regulatory requirements
 - Good for V2X, IAB, and non-terrestrial operation

Student Questions

Integrated Access and Backhaul

- mmWave backhaul is more cost effective than fiber backhaul for short distances required for small cells

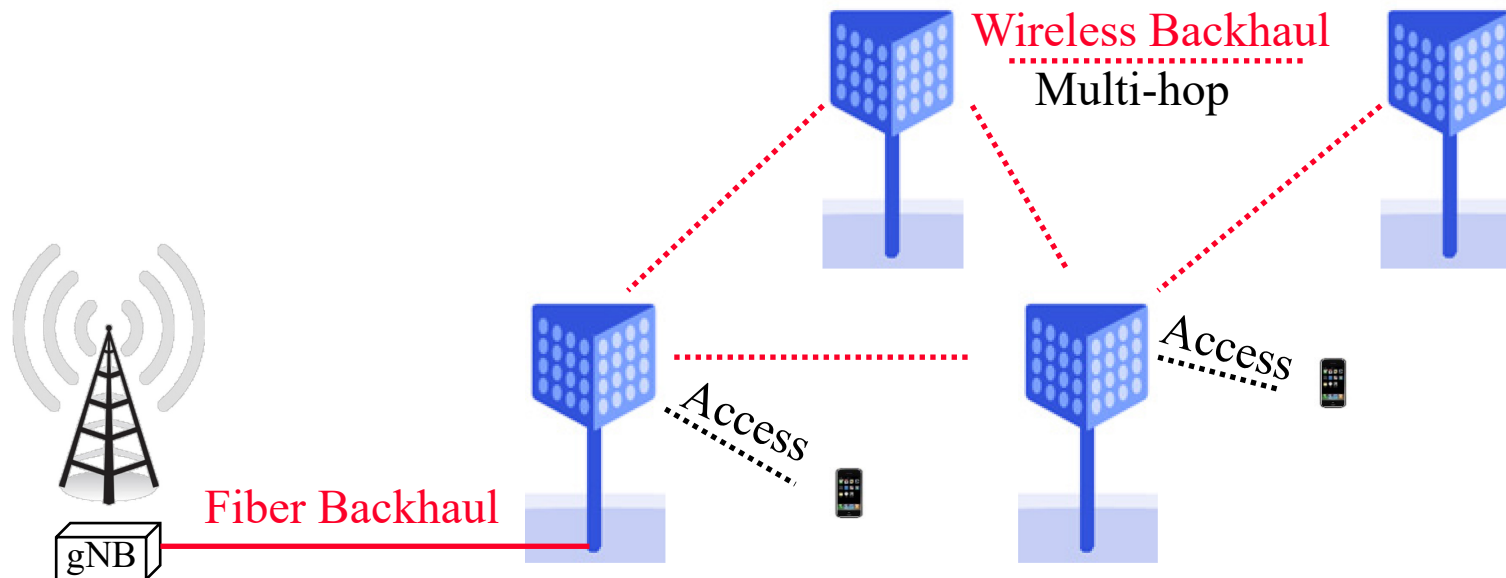

Student Questions

Ref: Qualcomm, "Expanding the 5G NR ecosystem and roadmap in 3GPP Release 16 and beyond," Sep 2018, 35 pp.,
<https://www.qualcomm.com/media/documents/files/expanding-the-5g-nr-ecosystem-and-roadmap-in-3gpp-rel-16-beyond.pdf>

IoT Techniques

- ❑ Non-orthogonal Multiple Access (NOMA):
 - Scheduled or grant-free access
 - Allows higher device density and network efficiency
- ❑ Grant-Free Uplink:
 - Contention-based access
 - Random upload of small data bursts
- ❑ Mesh Networking:
 - Mesh on unlicensed spectrum with upload on licensed
 - Extension of D2D
 - For low-power devices

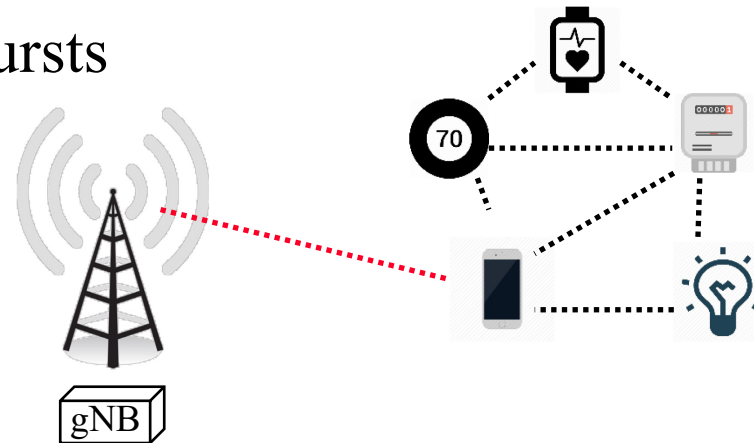

Ref: Qualcomm, "Expanding the 5G NR ecosystem and roadmap in 3GPP Release 16 and beyond," Sep 2018, 35 pp.,

<https://www.qualcomm.com/media/documents/files/expanding-the-5g-nr-ecosystem-and-roadmap-in-3gpp-rel-16-beyond.pdf>

Student Questions

Private 5G Networks for Industrial IoT

- ❑ Dedicated network for an enterprise
 - Factory Automation, Transport Industry, Electrical Power Distribution, Augmented Reality
- ❑ Small cell hosted or self-contained core network
- ❑ Locally managed \Rightarrow Sensitive data not exposed
- ❑ Interoperable inside/outside the site
- ❑ Licensed, unlicensed, and shared spectrum
- ❑ Ultra-reliable low-latency/time sensitive networking

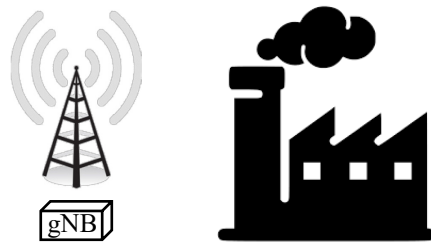

Student Questions

Ref: Qualcomm, "Expanding the 5G NR ecosystem and roadmap in 3GPP Release 16 and beyond," Sep 2018, 35 pp.,

<https://www.qualcomm.com/media/documents/files/expanding-the-5g-nr-ecosystem-and-roadmap-in-3gpp-rel-16-beyond.pdf>

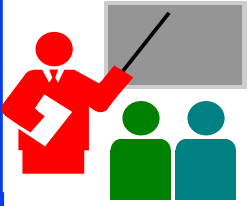

Summary

1. 5G is defined by IMT-2020 requirements in terms of 8 parameters: a peak rate up to 20 Gbps per user, User experienced rate of 100 Mbps, Mobility support to 500 km/h, a latency of 1 ms, a density of a million connections per m^2 , energy efficiency $100\times$ of 4G
2. Will use both sub-6GHz spectrum and mmWave using a scalable OFDM numerology that allows multiple subcarrier spacing, bandwidth parts and flexible resource allocation
3. Initially non-stand alone operation will allow 5G radio access network to work with legacy LTE core network. Later, standalone operation with 5G radio access and core network will be added.
4. New architectural features include network slicing, service based architecture, and control plane/user plane split.
5. Next release (Release 16) will add V2X, non-terrestrial networks, private networks, and several enhancements.

Student Questions

Reading List

- 5G Americas, "Wireless Technology Evolution - Transition from 4G to 5G, 3GPP Releases 14 to 16," Whitepaper, Oct 2018,
http://www.5gamericas.org/files/8015/4024/0611/3GPP_Rel_14-16_10.22-final_for_upload.pdf

Student Questions

Books

- ❑ E. Dahlman, S. Parkvall, J. Skold, “5G NR – The Next Generation Wireless Access Technology,” Academic Press, 2018, ISBN: [9780128143230](https://www.amazon.com/5G-NR-Next-Generation-Wireless-Access-Technology/dp/0128143230)
- ❑ A. Zaidi, et al, "5G Physical Layer: Principles, Models and Technology Components," Academic Press, 2018, 302 pp., ISBN: [9780128145784](https://www.amazon.com/5G-Physical-Layer-Principles-Models-Technology-Components/dp/0128145784)
- ❑ H. Holma, A. Toskala, J. Reunanen, "LTE Small Cell Optimization," Wiley, 2016, ISBN: [9781118912577](https://www.amazon.com/LTE-Small-Cell-Optimization/dp/0470677757)

Student Questions

References

- ❑ A. Toskala, "5G Standards and Outlook for 5G Unlicensed," June 2018, https://www.multefire.org/wp-content/uploads/5G_Standard_Toskala_MUlteFire-Open-Day-Meeting.pdf
- ❑ C. I, et al, "Recent Progress on C-RAN Centralization and Cloudification," IEEE Access, Vol. 2, 2014, pp. 1030-1039, <http://ieeexplore.ieee.org/iel7/6287639/6514899/06882182.pdf?arnumber=6882182>
- ❑ E. Guttman, "5G New Radio and System Standardization in 3GPP," https://www.itu.int/en/ITU-T/Workshops-and-Seminars/201707/Documents/Eric_Guttman_5G%20New%20Radio%20and%20System%20Standardization%20in%203GPP.pdf
- ❑ G. Pfeifer, "5G Technology Introduction, Market Status Overview and Worldwide Trials," 5G and IoT Seminar, Italy, May 2017, https://cdn.rohde-schwarz.com/it/seminario/5G_Seminar_Part1_Standardization_Market_PHY_170509_Italy.pdf
- ❑ <https://portal.3gpp.org/#55934-releases>
- ❑ ITU-R M.2083-0, "IMT Vision - Framework and overall objectives of the future development of IMT for 2020 and beyond," Sep. 2015. https://www.itu.int/dms_pubrec/itu-r/rec/m/R-REC-M.2083-0-201509-I!!PDF-E.pdf

Student Questions

References (Cont)

- ❑ ITU-R M.2411-0, "Requirements, evaluation criteria and submission templates for the development of IMT-2020," Nov. 2017, https://www.itu.int/dms_pub/itu-r/opb/rep/R-REP-M.2411-2017-PDF-E.pdf
- ❑ ITU-R M2376-0, "Technical Feasibility of IMT in bands above 6 GHz," July 2015, http://www.itu.int/dms_pub/itu-r/opb/rep/R-REP-M.2376-2015-PDF-E.pdf
- ❑ ITU-R Recommendation M.2083-0, "IMT Vision - Framework and overall objectives of the future development of IMT for 2020 and beyond," Sep. 2015, 21 pp., https://www.itu.int/dms_pubrec/itu-r/rec/m/R-REC-M.2083-0-201509-I!!PDF-E.pdf
- ❑ ITU-R, "Workplan, timeline, process and deliverables for the future development of IMT," 4pp., <http://www.itu.int/en/ITU-R/study-groups/rsg5/rwp5d/imt-2020/Documents/Antipated-Time-Schedule.pdf>
- ❑ L. Gupta, R. Jain, H. Chan, "Mobile Edge Computing - an important ingredient of 5G Networks," IEEE Softwarization Newsletter, March 2016, <http://sdn.ieee.org/newsletter/march-2016/mobile-edge-computing-an-important-ingredient-of-5g-networks>

Student Questions

References (Cont)

- ❑ Qualcomm, "Designing 5G NR - The 3GPP Release 15 global standard for a unified, more capable 5G air interface," Sep 2018, 37 pp.,
<https://www.qualcomm.com/media/documents/files/the-3gpp-release-15-5g-nr-design.pdf>
- ❑ Qualcomm, "Expanding the 5G NR ecosystem and roadmap in 3GPP Release 16 and beyond," Sep 2018, 35 pp.,
- ❑ Radiationhealthrisks.com, "Why 5G Cell Towers Are More Dangerous,"
<https://www.radiationhealthrisks.com/5g-cell-towers-dangerous/>
- ❑ Raj Jain, "SDN and NFV: Facts, Extensions, and Carrier Opportunities," AT&T Labs SDN Forum Seminar, April 10, 2014,
http://www.cse.wustl.edu/~jain/papers/adn_att.htm
- ❑ T. Richardson, R. Urbanke, "Multi-Edge Type LDPC Codes," 36 pp.,
<http://wii4u.free.fr/pdf/Multi-Edge%20Type%20LDPC%20Codes.pdf>
- ❑ V. Bioglio, C. Condo, I. Land, "Design of Polar Codes in 5G New Radio," 9 pp.
- ❑ W. Peng, et al, "Outage and Capacity Performance Evaluation of Distributed MIMO Systems over a Composite Fading Channel," Mathematical Problems in Engineering 2014, September 2014, 13 pp.,

Student Questions

Wikipedia Links

- ❑ https://en.wikipedia.org/wiki/3d_beamforming
- ❑ <https://en.wikipedia.org/wiki/3GPP>
- ❑ <https://en.wikipedia.org/wiki/4G>
- ❑ <https://en.wikipedia.org/wiki/5G>
- ❑ https://en.wikipedia.org/wiki/5G_NR_frequency_bands
- ❑ https://en.wikipedia.org/wiki/Antenna_diversity
- ❑ [https://en.wikipedia.org/wiki/Backhaul_\(telecommunications\)](https://en.wikipedia.org/wiki/Backhaul_(telecommunications))
- ❑ https://en.wikipedia.org/wiki/Beam_steering
- ❑ <https://en.wikipedia.org/wiki/Beamforming>
- ❑ <https://en.wikipedia.org/wiki/C-RAN>
- ❑ https://en.wikipedia.org/wiki/Channel_state_information
- ❑ https://en.wikipedia.org/wiki/Comparison_of_mobile_phone_standards
- ❑ https://en.wikipedia.org/wiki/Comparison_of_wireless_data_standards
- ❑ https://en.wikipedia.org/wiki/Control_channel
- ❑ https://en.wikipedia.org/wiki/Cooperative_MIMO
- ❑ https://en.wikipedia.org/wiki/Discrete-time_beamforming

Student Questions

Wikipedia Links (Cont)

- ❑ [https://en.wikipedia.org/wiki/Duplex_\(telecommunications\)](https://en.wikipedia.org/wiki/Duplex_(telecommunications))
- ❑ https://en.wikipedia.org/wiki/Edge_computing
- ❑ <https://en.wikipedia.org/wiki/Femtocell>
- ❑ <https://en.wikipedia.org/wiki/Fronthaul>
- ❑ https://en.wikipedia.org/wiki/History_of_smart_antennas
- ❑ https://en.wikipedia.org/wiki/List_of_5G_NR_networks
- ❑ https://en.wikipedia.org/wiki/List_of_mobile_phone_generations
- ❑ https://en.wikipedia.org/wiki/LTE-WLAN_Aggregation
- ❑ [https://en.wikipedia.org/wiki/LTE_\(telecommunication\)](https://en.wikipedia.org/wiki/LTE_(telecommunication))
- ❑ https://en.wikipedia.org/wiki/LTE_Advanced_Pro
- ❑ <https://en.wikipedia.org/wiki/MIMO>
- ❑ https://en.wikipedia.org/wiki/Mobile_broadband
- ❑ https://en.wikipedia.org/wiki/Mobile_edge_computing
- ❑ https://en.wikipedia.org/wiki/Mobile_phone_radiation_and_health
- ❑ <https://en.wikipedia.org/wiki/Multefire>
- ❑ https://en.wikipedia.org/wiki/Multi-user_MIMO
- ❑ https://en.wikipedia.org/wiki/Network_function_virtualization

Student Questions

Wikipedia Links (Cont)

- ❑ https://en.wikipedia.org/wiki/Next_Generation_Mobile_Networks
- ❑ https://en.wikipedia.org/wiki/Orthogonal_frequency-division_multiple_access
- ❑ https://en.wikipedia.org/wiki/Orthogonal_frequency-division_multiplexing
- ❑ https://en.wikipedia.org/wiki/Phased_array
- ❑ <https://en.wikipedia.org/wiki/Precoding>
- ❑ https://en.wikipedia.org/wiki/Radio_access_technology
- ❑ https://en.wikipedia.org/wiki/Radio_Network_Controller
- ❑ https://en.wikipedia.org/wiki/Radio_Resource_Control
- ❑ https://en.wikipedia.org/wiki/Radio_resource_management
- ❑ https://en.wikipedia.org/wiki/Remote_radio_head
- ❑ https://en.wikipedia.org/wiki/Service-oriented_architecture
- ❑ https://en.wikipedia.org/wiki/Single-carrier_FDMA
- ❑ https://en.wikipedia.org/wiki/Smart_antenna
- ❑ https://en.wikipedia.org/wiki/Software-defined_networking
- ❑ https://en.wikipedia.org/wiki/Time-division_multiplexing
- ❑ <https://en.wikipedia.org/wiki/Vehicle-to-everything>

Student Questions

Wikipedia Links (Cont)

- ❑ https://en.wikipedia.org/wiki/Vehicular_ad_hoc_network
- ❑ https://en.wikipedia.org/wiki/Wireless_electronic_devices_and_health

Student Questions

Acronyms

- ❑ 3GPP 3rd Generation Partnership Project
- ❑ AT&T American Telephone and Telegraph
- ❑ BBU Broadband Unit
- ❑ BWP Bandwidth Part
- ❑ CA Carrier Aggregation
- ❑ CBG Code block group
- ❑ CDMA Code Division Multiple Access
- ❑ CGNAT Carrier Grade Network Address Translator
- ❑ CoMP Co-ordinated multi-point transmission/reception
- ❑ CP Cyclic Prefix
- ❑ CRC Cyclic redundancy check
- ❑ CSI Channel State Information
- ❑ dB DeciBel
- ❑ dBm DeciBel Milliwatt
- ❑ DL Downlink
- ❑ DMRS Demodulation reference signals

Student Questions

Acronyms (Cont)

- ❑ eCoMP Enhanced Co-ordinate Multi-Point transmission/reception
- ❑ eICIC Enhanced Inter-Cell Interference Cancellation
- ❑ eMBB Enhanced Mobile Broadband
- ❑ eMBMS Enhanced Multimedia Broadcast Multicast System
- ❑ eNB Evolved Node-B
- ❑ EPC Evolved Packet Core
- ❑ FCC Federal Communications Commission
- ❑ FDD Frequency Division Duplexing
- ❑ FEC Forward Error Correction
- ❑ FFT Fast Fourier Transform
- ❑ FR Frequency Range
- ❑ FWA Fixed Wireless Access
- ❑ GEO Geo-stationary
- ❑ GHz Giga Hertz
- ❑ gNB 5g Node-B
- ❑ HARQ Hybrid Automatic Repeat Request

Student Questions

Acronyms (Cont)

- ❑ HPUE High-Power User Equipment
- ❑ IAB Integrated Access and Backhaul
- ❑ ICIC Inter-cell interference cancellation
- ❑ ICNIRP International Commission on Non-ionizing radiation
- ❑ ID Identifier
- ❑ IEEE Institution of Electrical and Electronic Engineers
- ❑ IMS IP Multimedia System
- ❑ IMT International Mobile Telecommunications
- ❑ IoT Internet of Things
- ❑ IP Internet Protocol
- ❑ ITU-R International Telecommunications Union- Radio
- ❑ ITU International Telecommunications Union
- ❑ kHz Kilo Hertz
- ❑ LAA License Assisted Access
- ❑ LDPC Low Density Parity Check Code
- ❑ LEO Low-Earth Orbit

Student Questions

Acronyms (Cont)

- ❑ LoRa Long Range wide area wireless
- ❑ LTE Long-Term Evolution
- ❑ MAC Media Access Control
- ❑ MBB Mobile Broadband
- ❑ MEC Mobile Edge Computing
- ❑ MHz Mega Hertz
- ❑ MIMO Multiple Input Multiple Output
- ❑ MME Mobility Management Entity
- ❑ mMTC Massive Machine Type Communication
- ❑ mmWave Milimeter wave
- ❑ NFV Network Function Virtualization
- ❑ NOMA Non-Orthogonal Multiple Access
- ❑ NR New Radio
- ❑ NSA Non-stand alone
- ❑ OFDM Orthogonal Frequency Division Multiplexing
- ❑ OFDMA Orthogonal Frequency Division Multiple Access

Student Questions

Acronyms (Cont)

- ❑ PDCCH Physical Downlink Control Channel
- ❑ PHY Physical Layer
- ❑ PRB Physical Resource Blocks
- ❑ PTRS Phase-Tracking Reference Signal
- ❑ PUCCH Physical Uplink Control Channel
- ❑ QAM Quadrature Amplitude Modulation
- ❑ QoS Quality of Service
- ❑ RAN Radio Access Network
- ❑ RAT Radio Access Technology
- ❑ REC Recommendation
- ❑ REP Report
- ❑ RF Radio Frequency
- ❑ RLC Radio Link Control
- ❑ RNC Radio Network Controller
- ❑ RRH Remote Radio Head
- ❑ RS Reference Signal

Student Questions

Acronyms (Cont)

- ❑ SA Standalone
- ❑ SCFDM Single-carrier frequency division multiplexing
- ❑ SCS Subcarrier spacing
- ❑ SDN Software Defined Networking
- ❑ SON Self-organizing network
- ❑ SRS Sounding Reference Signal
- ❑ SUL Supplementary Uplink
- ❑ TDD Time Division Duplexing
- ❑ TS Technical Specification
- ❑ TTI Transmission Time Interval
- ❑ UE User Element
- ❑ UL Uplink
- ❑ URLLC Ultra-Reliable low-latency communication
- ❑ VM Virtual Machine
- ❑ VoLTE Voice over LTE
- ❑ WRC World Radio Conference

Student Questions

Scan This to Download These Slides



**THANK
YOU**



Raj Jain

<http://rajjain.com>

Student Questions

http://www.cse.wustl.edu/~jain/cse574-20/j_205g.htm

Related Modules



CSE567M: Computer Systems Analysis (Spring 2013),
https://www.youtube.com/playlist?list=PLjGG94etKypJEKjNAa1n_1X0bWWNyZcof

CSE473S: Introduction to Computer Networks (Fall 2011),
https://www.youtube.com/playlist?list=PLjGG94etKypJWOSPMh8Azcg5e_10TiDw



Recent Advances in Networking (Spring 2013),
<https://www.youtube.com/playlist?list=PLjGG94etKypLHyBN8mOgwJLHD2FFIMGq5>

CSE571S: Network Security (Fall 2011),
<https://www.youtube.com/playlist?list=PLjGG94etKypKvzfVtutHcPFJXumyyg93u>



Video Podcasts of Prof. Raj Jain's Lectures,
<https://www.youtube.com/channel/UCN4-5wzNP9-ruOzQMs-8NUw>

Student Questions