

Introduction to Wireless Coding and Modulation

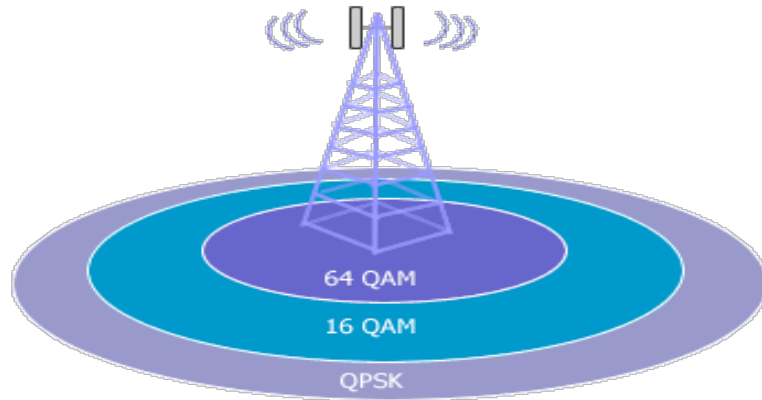

Raj Jain

Professor of Computer Science and Engineering
Washington University in Saint Louis
Saint Louis, MO 63130
Jain@cse.wustl.edu

Audio/Video recordings of this class lecture are available at:

<http://www.cse.wustl.edu/~jain/cse574-24/>

Student Questions



1. Frequency, Wavelength, and Phase
2. Electromagnetic Spectrum
3. Coding and modulation
4. Shannon's Theorem
5. Hamming Distance
6. Multiple Access Methods: CDMA
7. Doppler Shift

Note: This is the 1st in a series of 2 lectures on the wireless physical layer. Signal Propagation, OFDM, and MIMO are covered in the next lecture.

Student Questions

- ❖ There's much information on coding here, most of which hasn't been directly assessed by the homework. What section of the test might we expect to see content from module 3?

Sorry, all slides will be covered, not just homework. The exam is not exclusively homework.

Frequency, Period, and Phase

- A $\sin(2\pi ft + \theta)$, A = Amplitude, f=Frequency, θ = Phase, Period $T = 1/f$, Frequency is measured in Cycles/sec or **Hertz**.

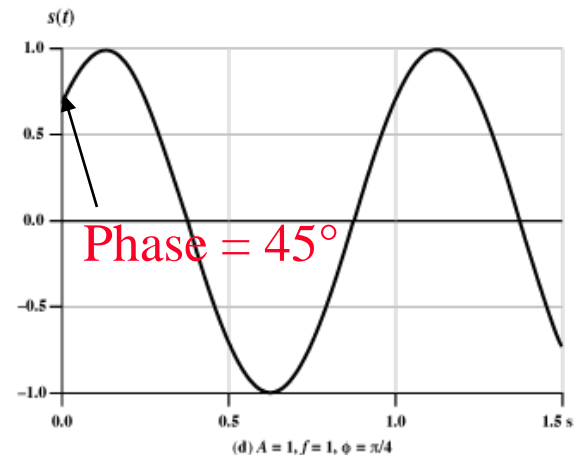
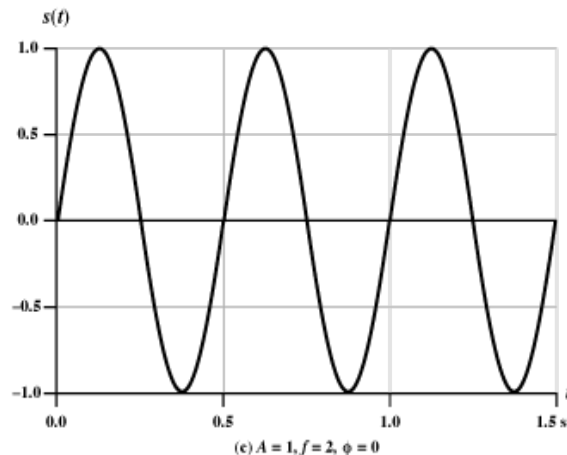
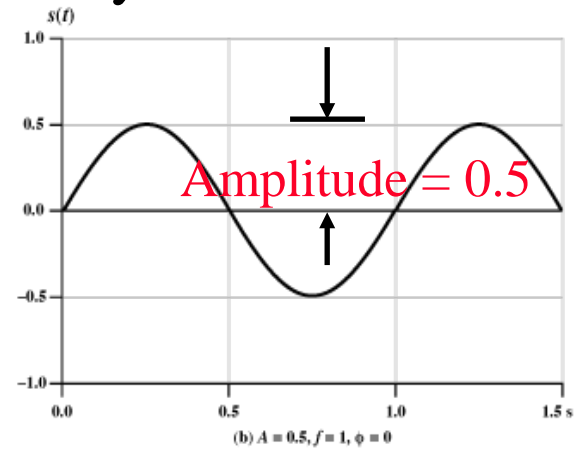
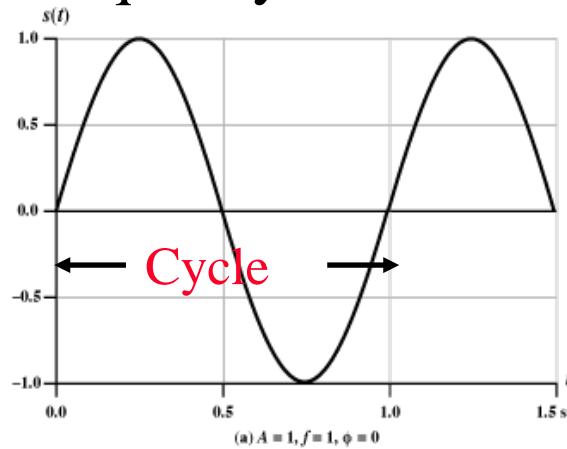

Student Questions

- Are we required to know the phase by looking at the wave chart or not? (for theta other than 0, 90, 45)

Understanding the phase is essential in understanding modulations. Not for reading from the chart.

- How would you know that a frequency is in a different phase when analyzing it from a point other than its origin?

You may need to know the phase difference between two waves at one location or one wave at different times.

Phase

- Sine wave with a phase of 45°

$$\begin{aligned} \sin\left(2\pi ft + \frac{\pi}{4}\right) &= \sin(2\pi ft) \cos\left(\frac{\pi}{4}\right) + \cos(2\pi ft) \sin\left(\frac{\pi}{4}\right) \\ &= \frac{1}{\sqrt{2}} \sin(2\pi ft) + \frac{1}{\sqrt{2}} \cos(2\pi ft) \end{aligned}$$

In-phase component I + Quadrature component Q

$$Q = A \cos(2\pi ft)$$

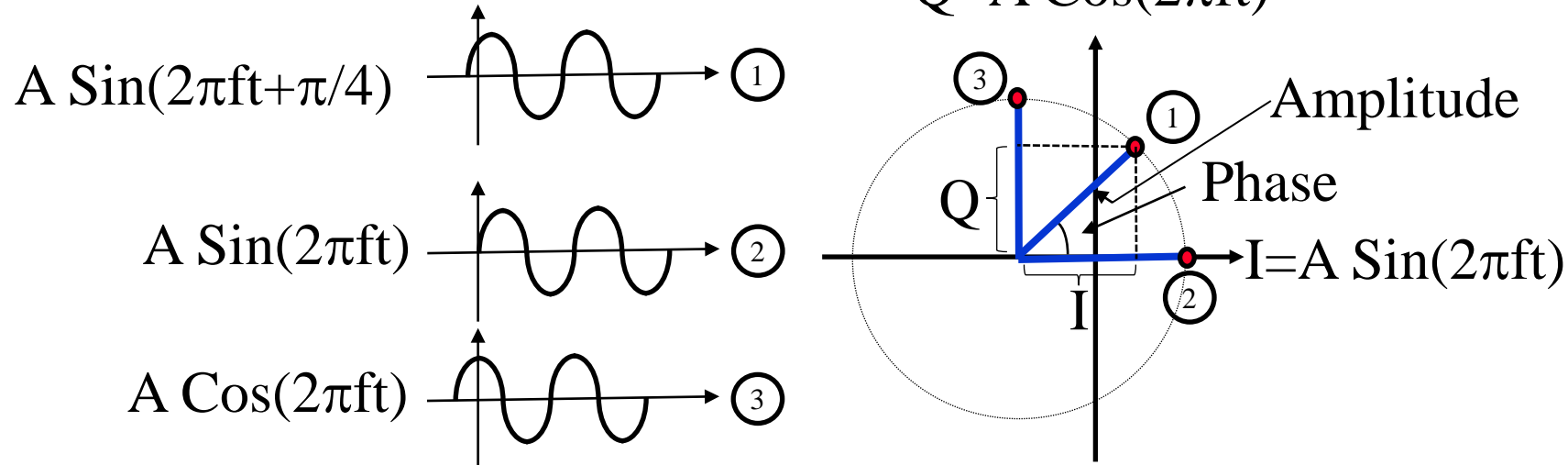

Student Questions

- When would we use the normal equation for phase, and when would we use the expanded version?
- Why do we ignore the $\cos(\pi/4)$ for the Q component, and the $\sin(\pi/4)$ for the I component in the Phase graph on the bottom right?

Wavelength

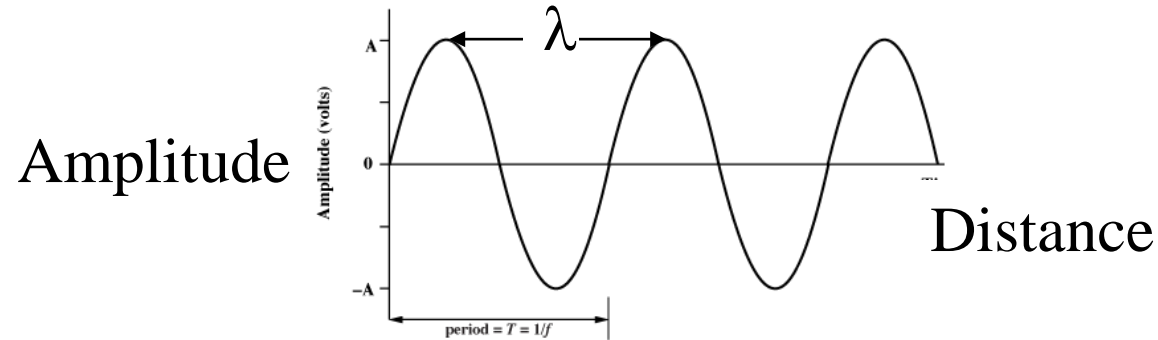

- ❑ Distance occupied by one cycle
- ❑ Distance between two points of the corresponding phase in two consecutive cycles
- ❑ Wavelength = λ
- ❑ Assuming signal velocity v
 - $\lambda = vT$
 - $\lambda f = v$
 - $c = 3 \times 10^8$ m/s (speed of light in free space) = **300 m/ μ s**

Student Questions

- ❑ Is it more expensive to produce a satellite that can listen across a range of frequencies all at once, or that it would slow down speed if it was scanning in real time?

Yes. Software defined radios can listen across a range of frequencies. It is too early to discuss that.

Example

□ Frequency = 2.5 GHz

$$\begin{aligned}\text{Wavelength} = \lambda &= \frac{c}{f} \\ &= \frac{300 \text{ m}/\mu\text{s}}{2.5 \times 10^9} \\ &= 120 \times 10^{-3} = 120 \text{ mm} = 12 \text{ cm}\end{aligned}$$

Student Questions

□ Does Wi-Fi use both 2.4GHz and 2.5GHz?

2.4 and 2.5 are the same. Wi-Fi uses 2.412 GHz to 2.495 GHz.

Rounding to the first decimal digit will give you one or the other.

Time and Frequency Domains

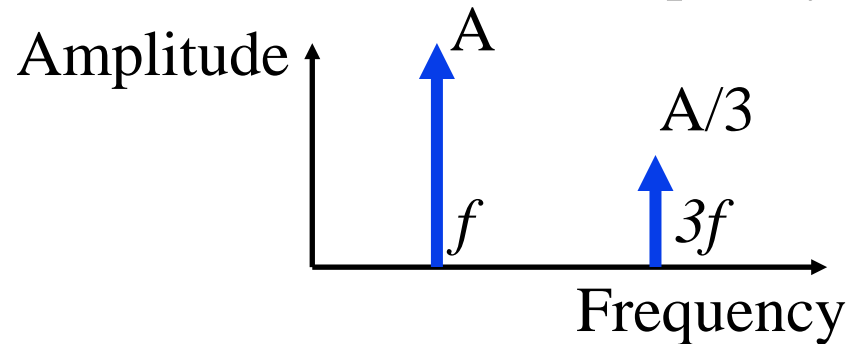
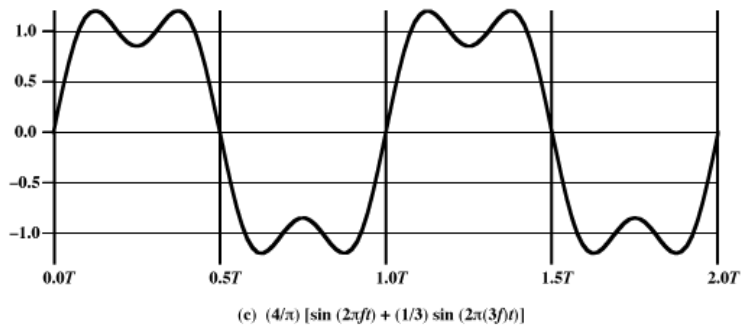
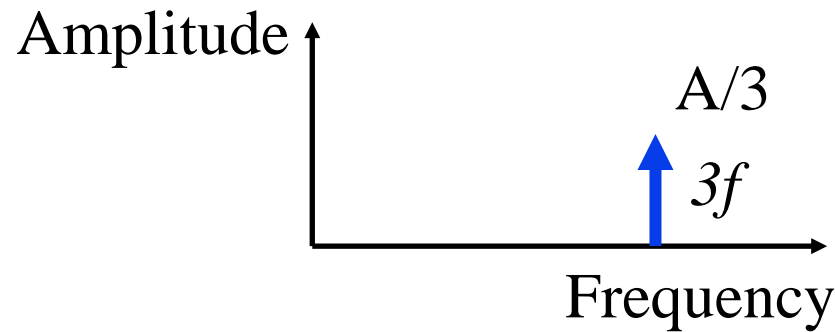
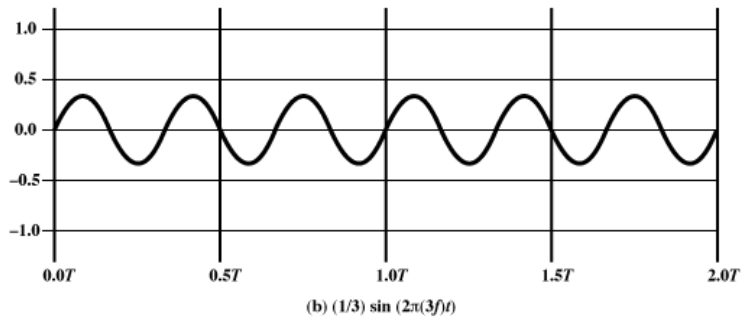
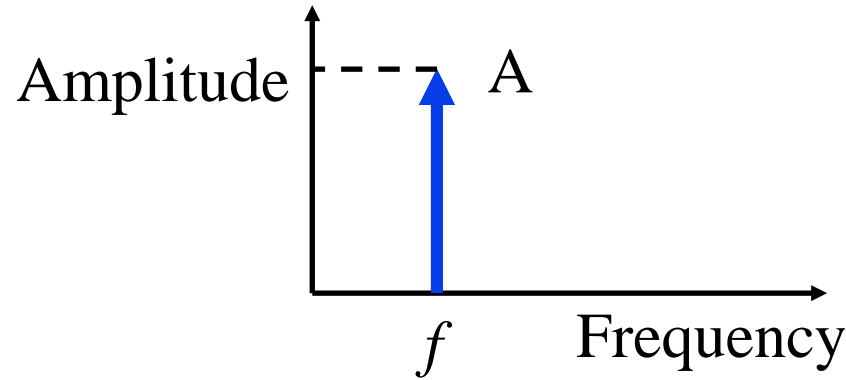
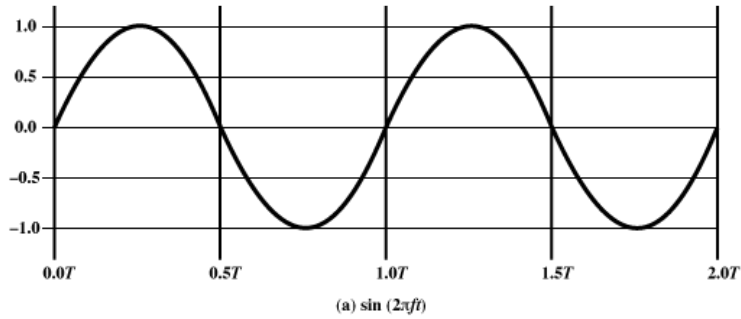

Student Questions

- ❑ Will Fourier transforms be important for wireless networking frequencies?

Yes, for EE students

Could you explain the difference between the time domain and frequency domain here a bit more?

Time domain = As a function of time

Frequency domain = As a function of frequency

In practice, are only the first and third harmonics used to send bits?

No. An infinite number of harmonics are always present.

Only one harmonic is shown here as an example.

Time and Frequency Domains

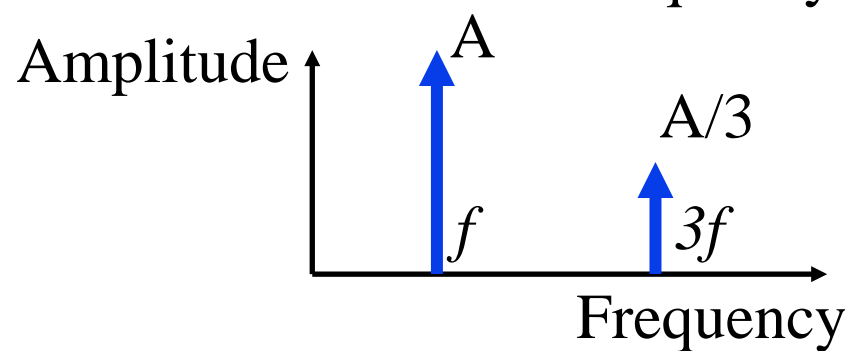
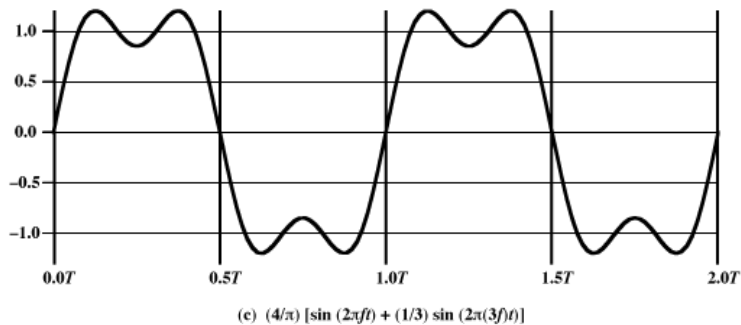
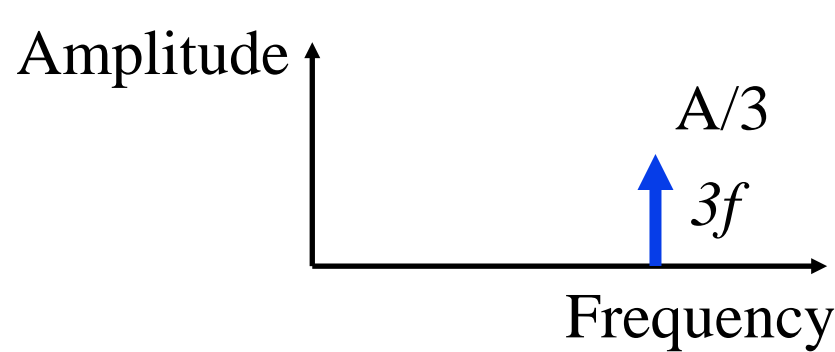
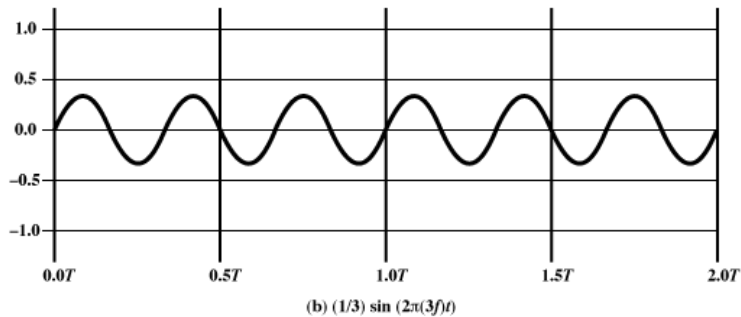
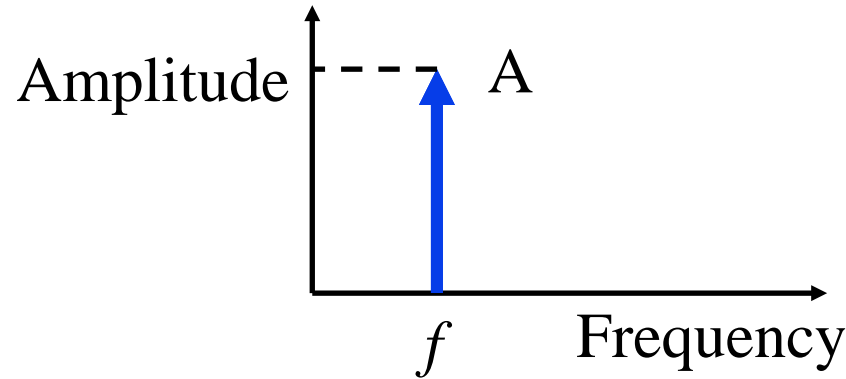
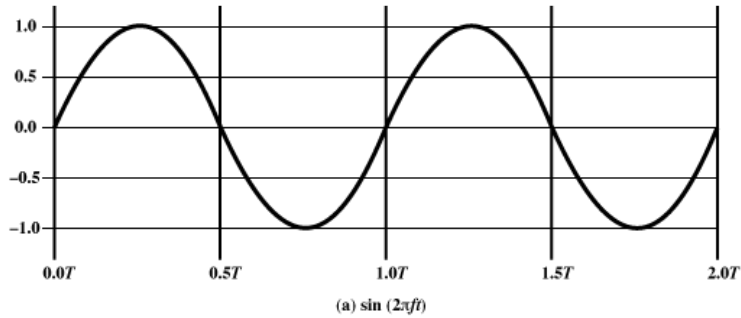

Student Questions

- Can you go into more detail on what you mean by 5th and 7th harmonics?

Fundamental = $A \sin(2\pi ft + \phi)$

k^{th} harmonic = $B \sin(2k\pi ft + \gamma)$

- Can you explain a practical example where the decomposition of a signal into its frequency components, as shown here, is crucial for analysis or design in engineering?

Yes, RF equipment is designed for a frequency or a frequency range.

The signal beyond this range is lost. A square wave produces infinite frequency range.

Time and Frequency Domains

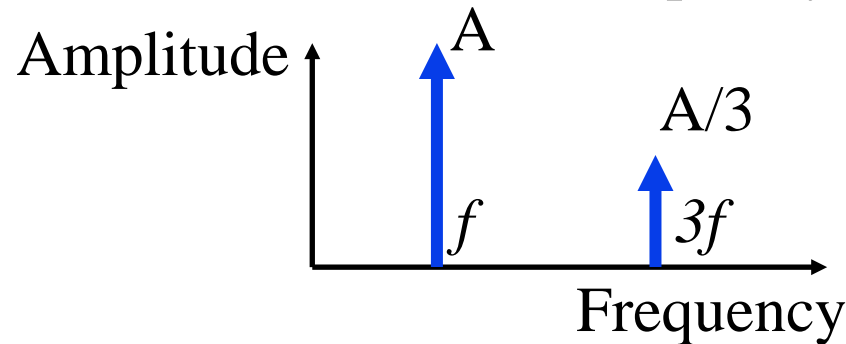
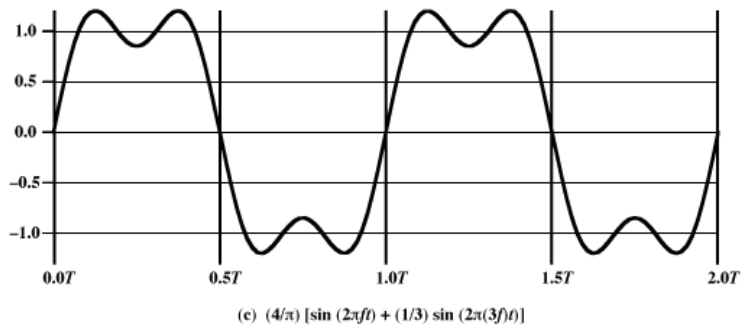
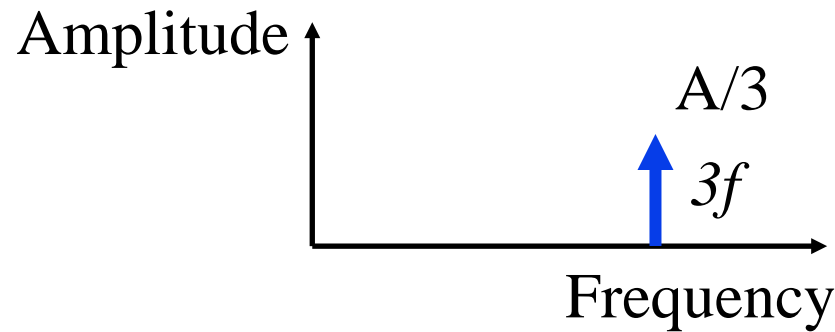
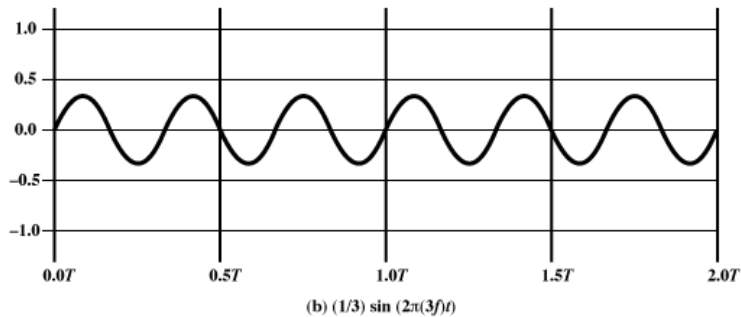
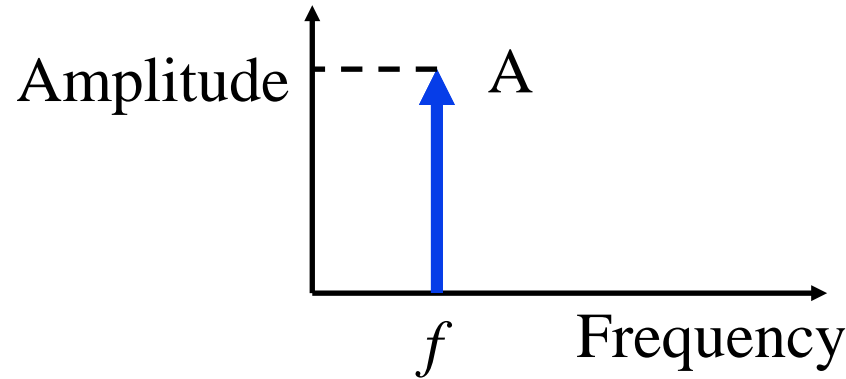
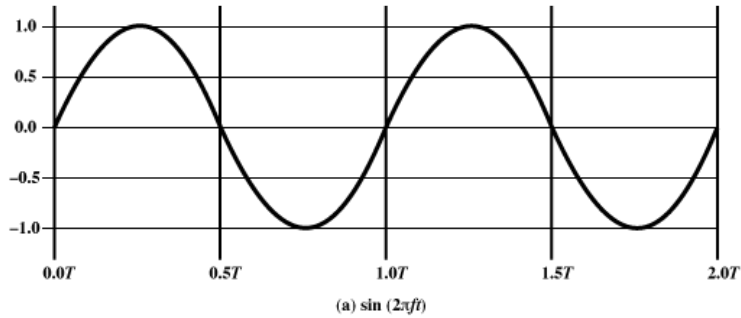

Student Questions

- You describe the impulse in the frequency domain as 'power at one frequency and no power everywhere else', is power or amplitude generally talked about in frequency domain?

Both power and amplitude are discussed in both time and frequency domain. We flip our discussion between the domains frequently.

Electromagnetic Spectrum

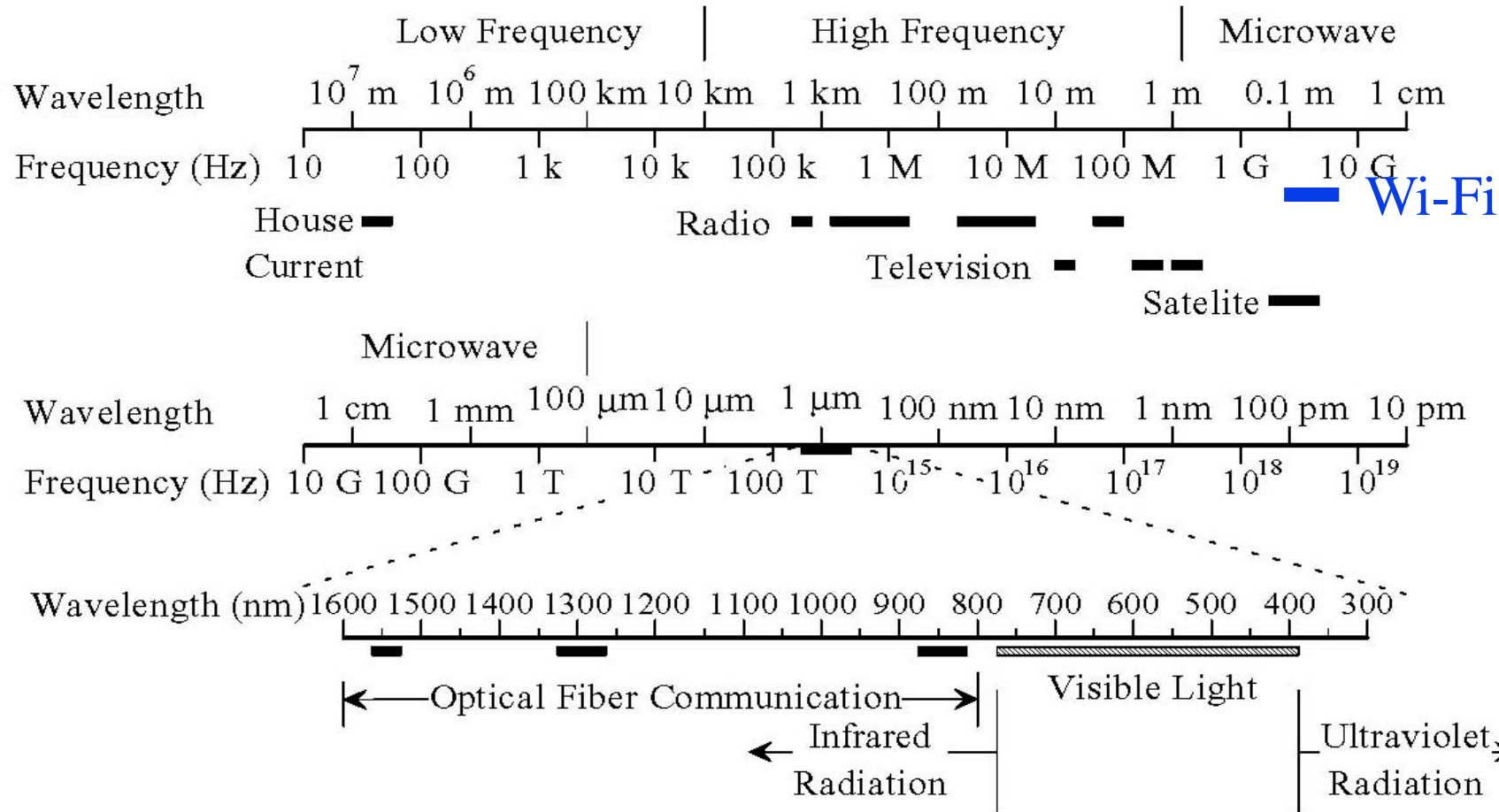

❑ Wireless communication uses 100 kHz to 60 GHz

Student Questions

- ❑ Does THz domain have any wireless application at all?
Yes. Li-Fi is light-based Wi-Fi like technology.
- ❑ For dual band wireless access points, does the equipment have two physical antennas?
In the past. Now discrete Fourier transforms are used to separate frequencies.
- ❑ Which electrical components are responsible for managing signals & frequencies for networking?
- ❑ What are the differences between Wi-Fi and wireless? are they the same?
Wi-Fi is just one of the wireless protocols. Bluetooth is another. 5G is yet another.
- ❑ Does the Blue line between 10GHz and 100GHz also represent Wi-Fi?
Yes. 60GHz is used in some Wi-Fi systems.
- ❑ Should we be concerned about the electromagnetic spectrum being used up, or is there still plenty of frequencies/wavelengths to use?
Yes, we are concerned. Researchers are finding ways to improve the usage of current bands and ways of using challenging-to-use bands.
- ❑ What are the three lines in the Optical Fiber communication part referred to?
800 nm, 1300 nm, and 1500 nm are frequently used.
- ❑ What causes lower frequencies to require a wire for transmission?
They get attenuated fast in non-conducting media.

Electromagnetic Spectrum

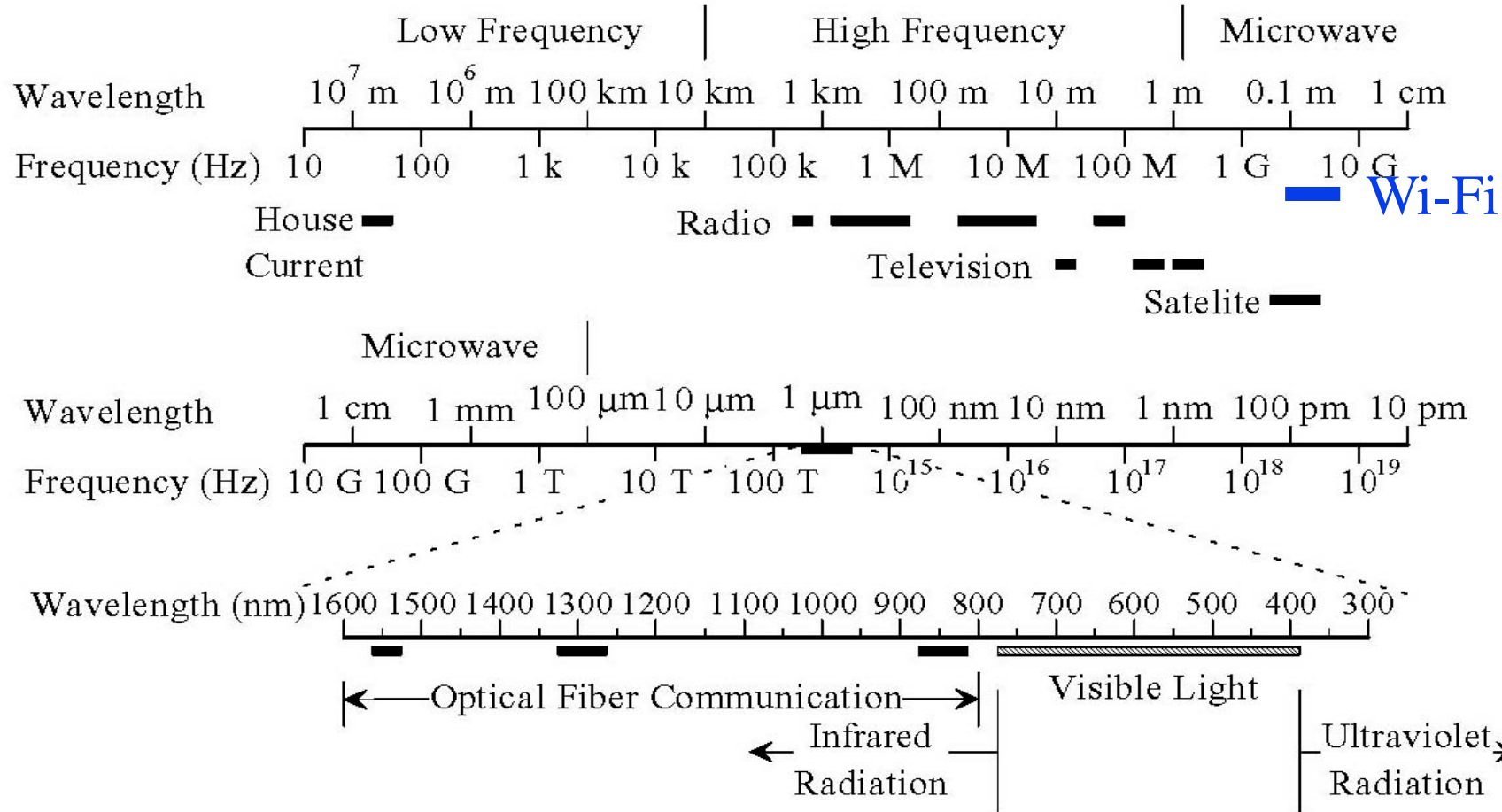

❑ Wireless communication uses 100 kHz to 60 GHz

Student Questions

❑ Wi-Fi operates at 2.4 GHz or 5 GHz, so why does the Wi-Fi band lie between 10 GHz and 100 GHz in the figure?

You are right. The figure has been corrected.

DeciBels

❑ Attenuation = $\text{Log}_{10} \frac{P_{in}}{P_{out}}$ Bel

❑ Attenuation = $10 \text{Log}_{10} \frac{P_{in}}{P_{out}}$ deciBel

❑ Attenuation = $20 \text{Log}_{10} \frac{V_{in}}{V_{out}}$ deciBel Since, $P=V^2I$

❑ **Example 1:** $P_{in} = 10 \text{ mW}$, $P_{out}=5 \text{ mW}$

$$\text{Attenuation} = 10 \log_{10} (10/5) = 10 \log_{10} 2 \approx 3 \text{ dB}$$

❑ **Example 2:** $P_{in} = 100 \text{ mW}$, $P_{out}=1 \text{ mW}$

$$\text{Attenuation} = 10 \log_{10} (100/1) = 10 \log_{10} 100 = 20 \text{ dB}$$

$$P_{in} = 20 \text{ dBm}, P_{out} = 0 \text{ dBm}, \text{Atten.} = 20 \text{ dBm} - 0 \text{ dBm} = 20 \text{ dB}$$

Student Questions

- ❑ So attenuation = P_{in}/P_{out} dB. What is P_{in}/P_{out} in this case, I am a bit unsure.

P_{in} is the input power. P_{out} is the output power. Both measured in Watts.

- ❑ Why is the Voltage attenuation (third formula) 20Log_{10} whereas the second formula for power is 10Log_{10} ? (Does voltage decay twice as fast as power?)

$P=V^2I$; V is the Voltage, and I is the current. $\text{Log } P = 2 \text{Log } V + \text{Log } I$

- ❑ Can you go over the different ways of calculating attenuation again? Why can we get attenuation just using voltage in and voltage out, without power?

Because the current (flow of photons or electrons) is constant.

- ❑ What are P_{in} and P_{out} ? Power before the signal and power after the circuit sends the signal?

Power in and Power out for any system, e.g., space, wire, box

- ❑ How does attenuation relate to the sound volume given that both are deciBels?

Volume = Power

Decibels

- ❑ Attenuation = $\text{Log}_{10} \frac{P_{in}}{P_{out}}$ Bel
- ❑ Attenuation = $10 \text{Log}_{10} \frac{P_{in}}{P_{out}}$ deciBel
- ❑ Attenuation = $20 \text{Log}_{10} \frac{V_{in}}{V_{out}}$ deciBel Since, $P=V^2I$
- ❑ **Example 1:** $P_{in} = 10 \text{ mW}$, $P_{out}=5 \text{ mW}$
Attenuation = $10 \log_{10} (10/5) = 10 \log_{10} 2 \approx 3 \text{ dB}$
- ❑ **Example 2:** $P_{in} = 100\text{mW}$, $P_{out}=1 \text{ mW}$
Attenuation = $10 \log_{10} (100/1) = 10 \log_{10} 100 = 20 \text{ dB}$

Student Questions

- ❑ For calculating the attenuation of measured power to the attenuation of measured voltage, why do we assume that the current I_{in} will be equal to I_{out} ?

Electrons don't get lost except in nuclear reactors.

- ❑ When we say (P_{in}/P_{out}) in calculating the attenuation in dB, does context matter? Say we transmit some power from a transmitter that would be the output power, and at the receiver, it will be the input power.

P_{in} and P_{out} relate to the same subsystem, e.g., transmitting antenna, wireless link, or receiving antenna.

Decibels

- ❑ Attenuation = $\text{Log}_{10} \frac{P_{in}}{P_{out}}$ Bel
- ❑ Attenuation = $10 \text{Log}_{10} \frac{P_{in}}{P_{out}}$ deciBel
- ❑ Attenuation = $20 \text{Log}_{10} \frac{V_{in}}{V_{out}}$ deciBel Since, $P=V^2I$
- ❑ **Example 1:** $P_{in} = 10 \text{ mW}$, $P_{out}=5 \text{ mW}$
Attenuation = $10 \log_{10} (10/5) = 10 \log_{10} 2 \approx 3 \text{ dB}$
- ❑ **Example 2:** $P_{in} = 100\text{mW}$, $P_{out}=1 \text{ mW}$
Attenuation = $10 \log_{10} (100/1) = 10 \log_{10} 100 = 20 \text{ dB}$

Student Questions

- ❖ dB are related to Watts. How does it relate to wave amplitude, frequency, etc.?

If voltage is constant, $P=V^2I$

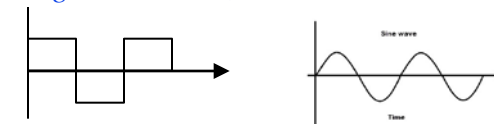

Root mean squared (RMS) amplitude values are used for sine waves. Amplitude indicates the voltage.

Coding Terminology

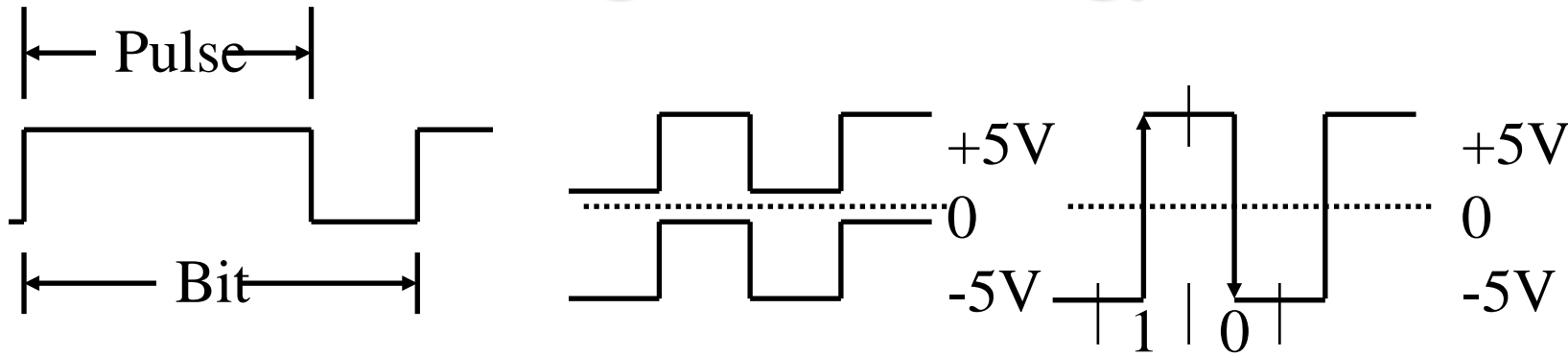

- ❑ **Signal element:** Pulse (of constant amplitude, frequency, phase)
- ❑ **Modulation Rate:** 1/Duration of the smallest element =Baud rate
- ❑ **Data Rate:** Bits per second

Student Questions

- ❑ Can you go over the “duration of the smallest element” in the example? You pointed to something in the video, but we can't see the board.
The first figure shows a code consisting of a long element followed by a short element, like the Morse Code. In this case, the small element is the shortest. In the other two figures, all elements are one size.
- ❑ Multiple elements (pulses) can comprise a symbol.
Yes. In the first figure, 1 symbol=2 Elements. In the other two figures, one symbol=one element.
- ❑ I am confused about the element and Baud and how the figures explain the terminology
A symbol consists of one or more bits. Each symbol is transmitted as one or more elements. The smallest element determines the Baud rate. Users care about bits. Coders care about symbols. Electronics must be designed to transmit/receive the smallest element, i.e., the Baud rate. The medium (air) has limited bandwidth (frequency or Hertz).
- ❖ What is the exact range of a bit and pulse in the figure?
A constant signal defines a pulse. A bit is defined by coding. It can be one or more pulses or a transition.

Coding Terminology

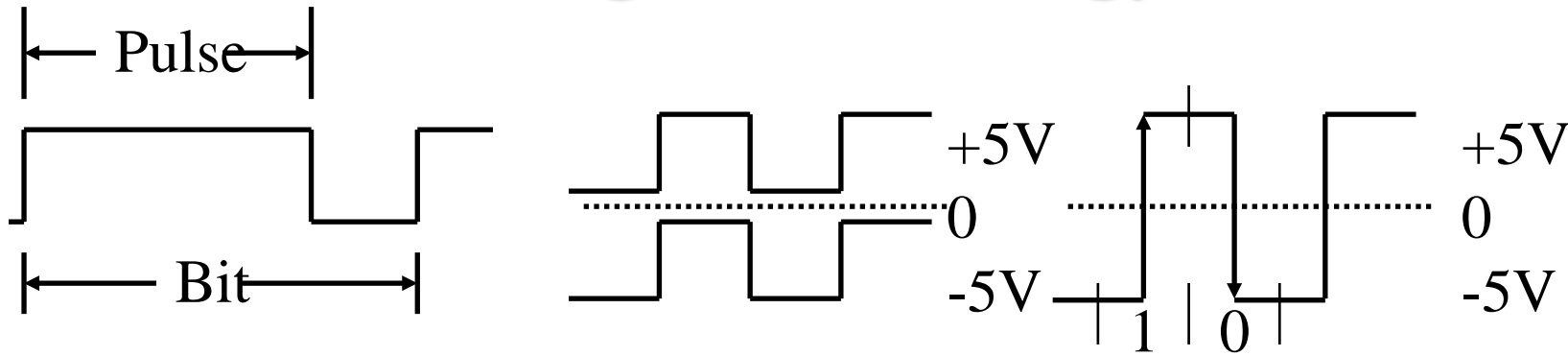

- ❑ **Signal element:** Pulse (of constant amplitude, frequency, phase) = **Symbol**
- ❑ **Modulation Rate:** 1/Duration of the smallest element = Baud rate
- ❑ **Data Rate:** Bits per second

Student Questions

- ❑ Do the diagrams show bit encoding?

Yes.

- ❑ How do these relate to bit encoding with QAM?

QAM is better understood in the polar coordinates. See Slide 3-13.

- ❑ Why one-bit duration/length is longer than one symbol/pulse duration? Shouldn't it be the opposite?

Because one bit/character may be encoded with more than one symbol. It is also possible to encode it with a transition.

- ❑ In hardware, Baud means bits per second. This slide seems to define it differently, is this due to different contexts?

Your understanding is incorrect. Baud is symbols per second (max).

Coding Terminology

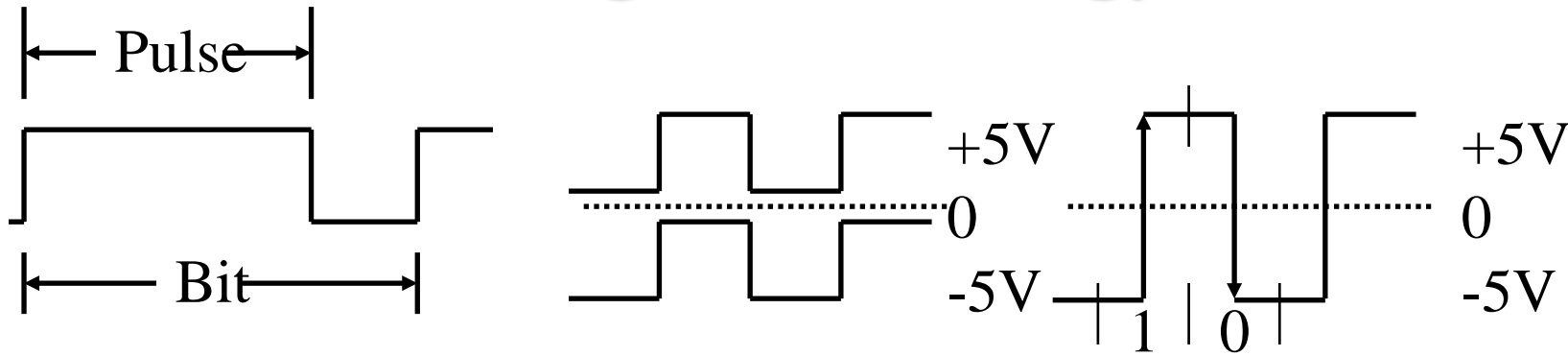

- ❑ **Signal element:** Pulse (of constant amplitude, frequency, phase) = **Symbol**
- ❑ **Modulation Rate:** 1/Duration of the smallest element = Baud rate
- ❑ **Data Rate:** Bits per second

Student Questions

- ❑ Could you explain the difference between pulse versus bit?

Pulse is the shortest element with the same amplitude, frequency, or phase. The bit is the data that we want to send.

- ❑ Could we use more than 2 pulses to represent 1 bit?

Yes. We often do.

- ❑ What does the "Smallest element" mean, does it mean the short pulse?

A pulse spans the duration when the amplitude, phase, and/or frequency remain the same.

- ❑ Could you explain slide 10 again?

Sure.

Coding Terminology

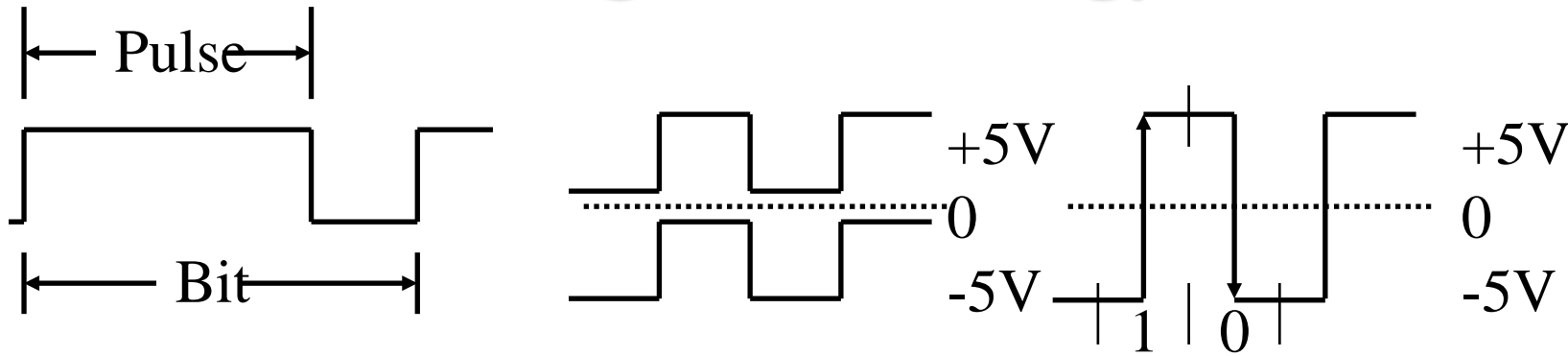

- ❑ **Signal element:** Pulse (of constant amplitude, frequency, phase) = **Symbol**
- ❑ **Modulation Rate:** 1/Duration of the smallest element = Baud rate
- ❑ **Data Rate:** Bits per second

Student Questions

- ❑ A mobile phone receiver is within the near-field of electronic components that generate fluctuating EM fields, e.g., microprocessor, display, gyroscope, etc.. How are mobile phones designed to avoid this interference?

Coding is one of the components that helps filter out interference. We will see others later.

Modulation

- ❑ Digital version of modulation is called **keying**
- ❑ **Amplitude Shift Keying (ASK):**

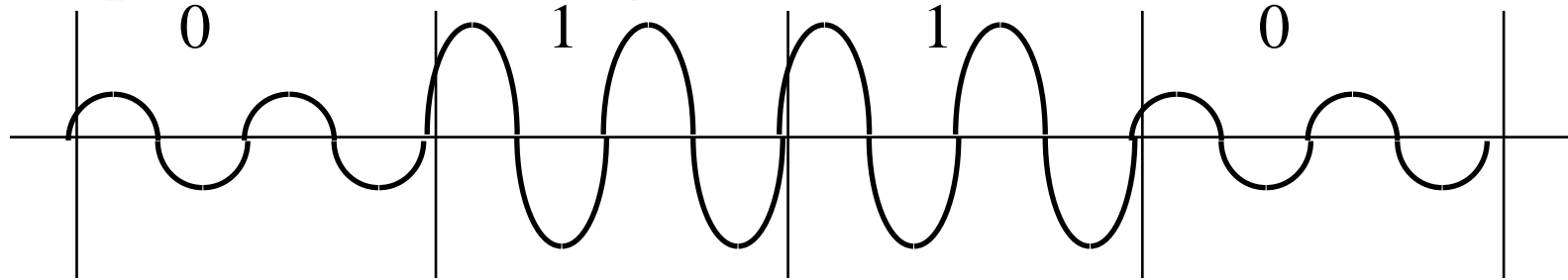

- ❑ **Frequency Shift Keying (FSK):**

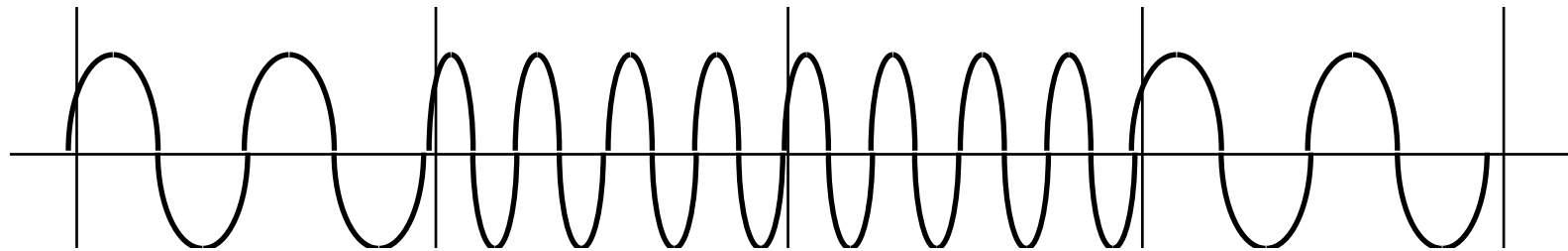

- ❑ **Phase Shift Keying (PSK):** Binary PSK (BPSK)

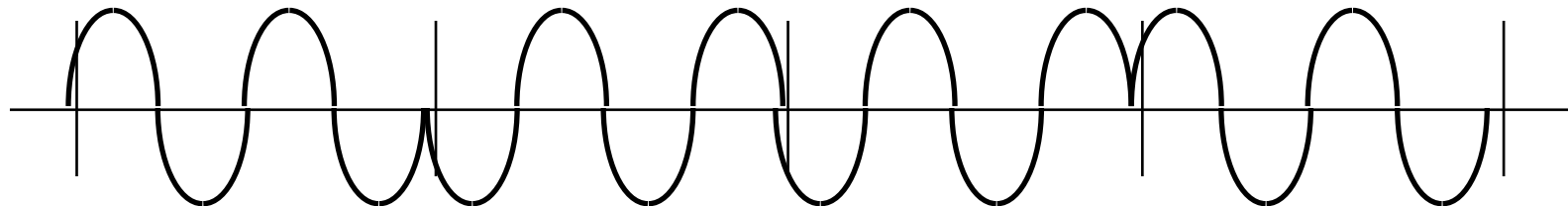

Student Questions

❑ Is it correct to say that keying uses an analog signal rather than a digital signal?
Basically, The entire world is mostly analog/continuous. Digital/discrete is a human creation.

❑ Is frequency or phase key shifting possible with wireless? I assumed since wireless receivers listen at a frequency that we can't then change the frequency as a way of sending data.

Wireless receivers and senders, both use the same frequency band.

Modulation

- ❑ Digital version of modulation is called **keying**
- ❑ **Amplitude Shift Keying (ASK):**

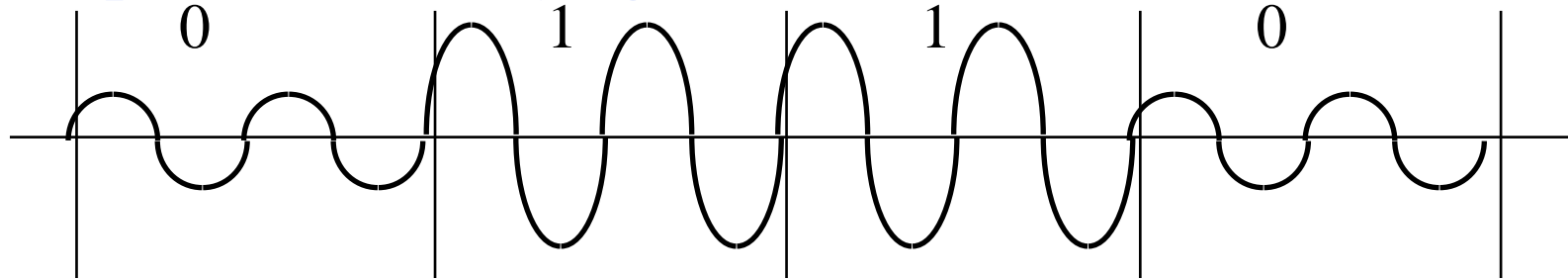

- ❑ **Frequency Shift Keying (FSK):**

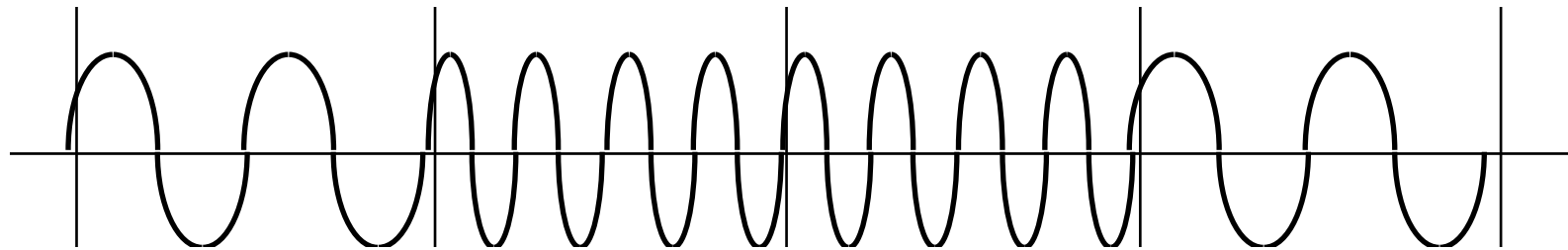

- ❑ **Phase Shift Keying (PSK):** Binary PSK (BPSK)

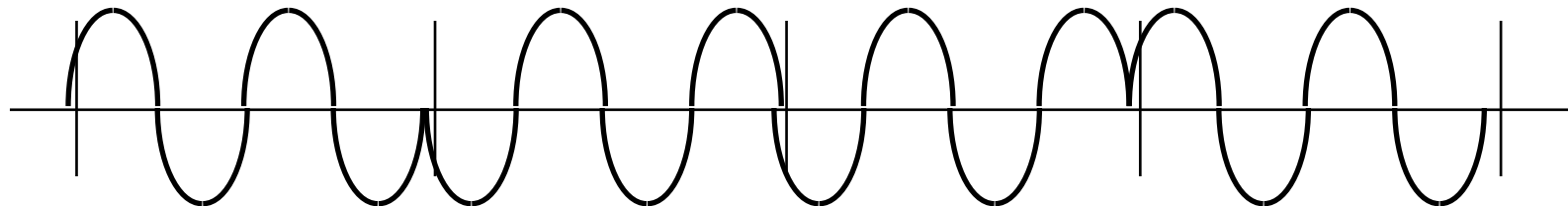

Student Questions

- ❑ In the video, you said the best one is not defined yet, does it mean that this is a potential research direction?

Each of these has some advantages and disadvantages over others.

- ❑ Can I say that keying is a form of electromagnetic modulation that specifically pertains to digital signals, while electromagnetic modulation also includes analog methods?

Yes.

Modulation (Cont)

- **Differential BPSK:** Does not require original carrier

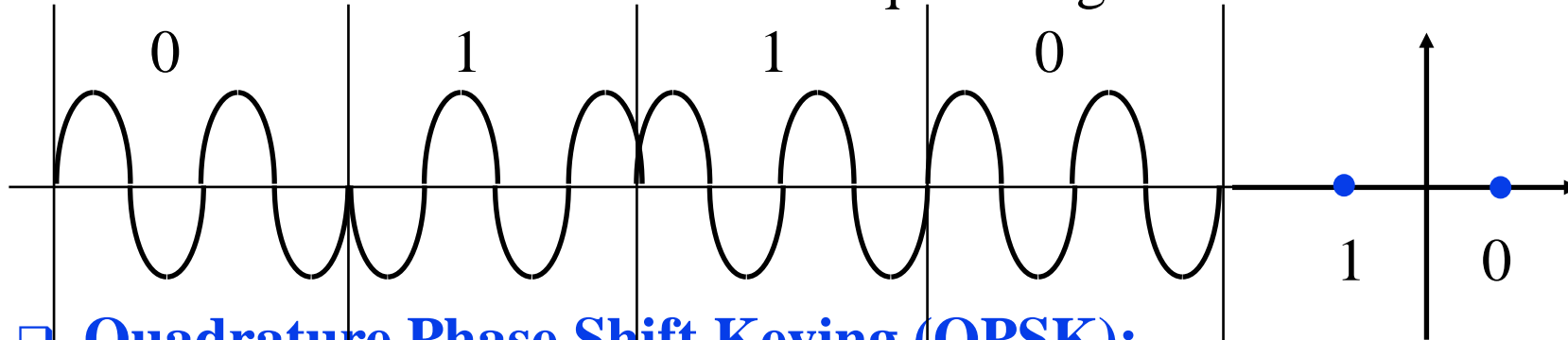

- **Quadrature Phase Shift Keying (QPSK):**

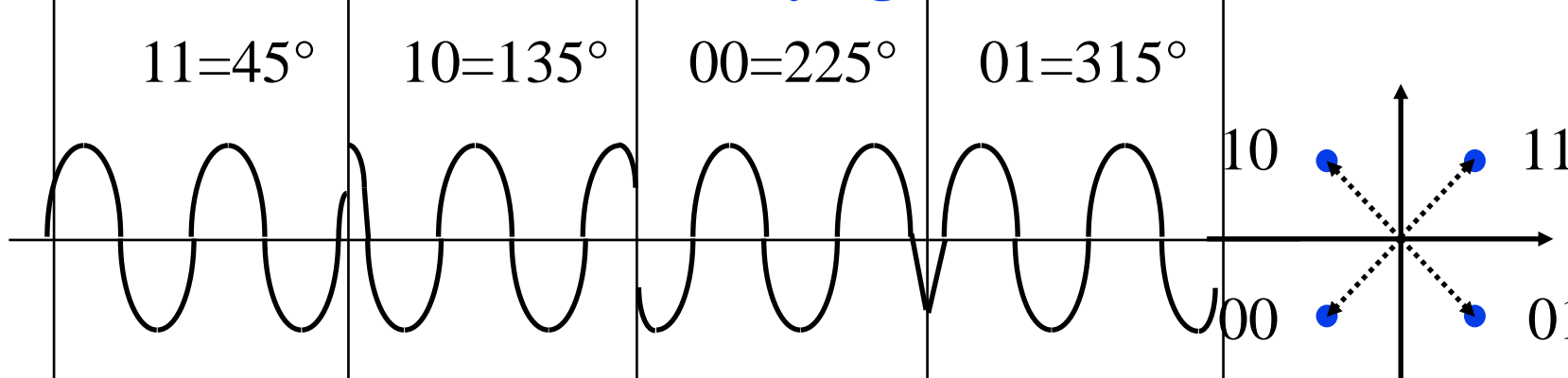

- In-phase (I) and Quadrature (Q) or 90° components are added

Ref: Electronic Design, "Understanding Modern Digital Modulation Techniques,"

<https://www.electronicdesign.com/communications/understanding-modern-digital-modulation-techniques>

<http://www.cse.wustl.edu/~jain/cse574-24/>

©2024 Raj Jain

Student Questions

- Please go over the QPSK. I am specifically confused on how you translate the wavelengths to the graphs on the right to depict the change in signal.

See Slide 3-4 for relationship between the waveform and the polar representation. QPSK uses 4 (Quad) different phases. BPSK use 2 (binary) phases.

- Could you explain the x-y coordinates of Differential BPSK?

Differential=>The difference between two consecutive signals is used to code the symbol. Here, 1=Change of Phase, 0=No change in phase.

- How are we able to create and send the non-continuous waveforms for QPSK?

Electronic circuits are used to generate sine waves, change their phases and transmit a different phase, frequency, or amplitude as needed.

- How do we make decisions for symbols at the receiver for QPSK modulation?

We measure the phase. We need to synchronize first.

- Comparing QPSK with others, there are some non-continuous points. How does it work, and will it influence recognition?

The media smooths out the transitions. But phase difference is recognized by proper calculations.

Modulation (Cont)

- ❑ **Differential BPSK:** Does not require original carrier

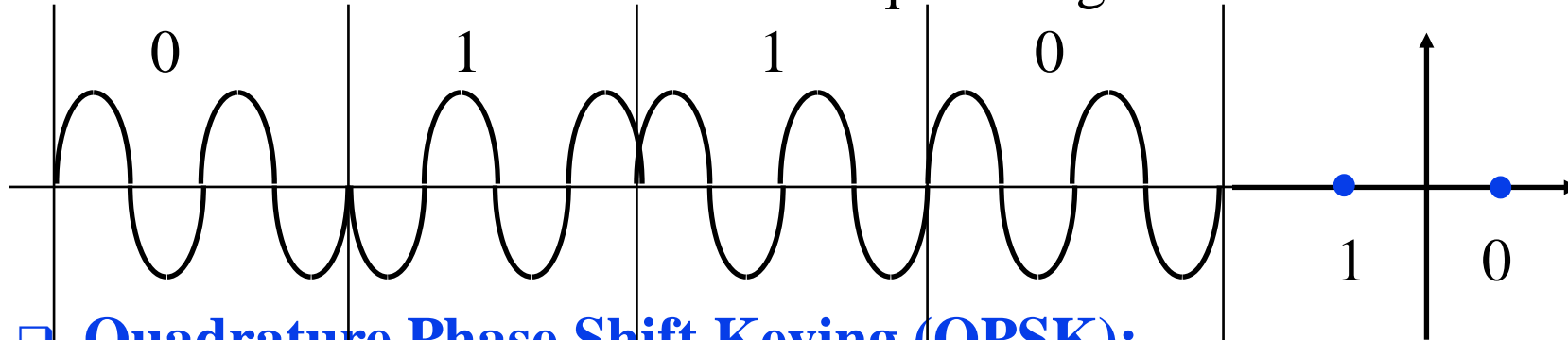

- ❑ **Quadrature Phase Shift Keying (QPSK):**

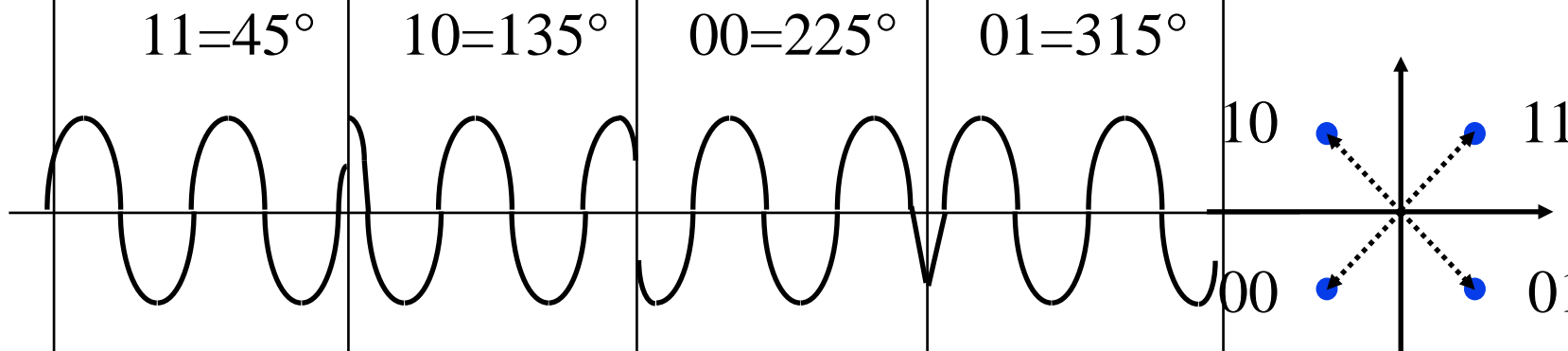

- ❑ In-phase (I) and Quadrature (Q) or 90° components are added

Ref: Electronic Design, "Understanding Modern Digital Modulation Techniques,"

<https://www.electronicdesign.com/communications/understanding-modern-digital-modulation-techniques>

<http://www.cse.wustl.edu/~jain/cse574-24/>

©2024 Raj Jain

Student Questions

- ❑ For the differential BPSK, if one of the signals gets lost, how can we determine whether the signal following the lost one has changed since we have no information about the previous signal to compare them?

You will be in sync after one bit.

- ❑ Is the first symbol in differential BPSK discarded when decoding? Since the first symbol does not have a previous symbol.

Yes.

- ❑ Why are Quadrature Phases 45° , 135° , 225° , and 315° Instead of 0° , 90° , 180° , and 270° ?

That is allowed, too.

Modulation (Cont)

- ❑ **Differential BPSK:** Does not require original carrier

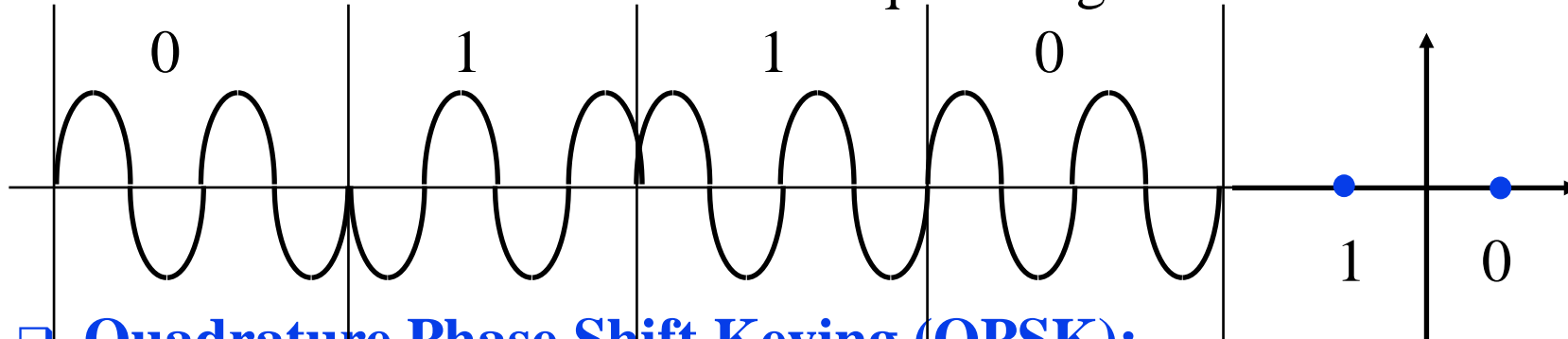

- ❑ **Quadrature Phase Shift Keying (QPSK):**

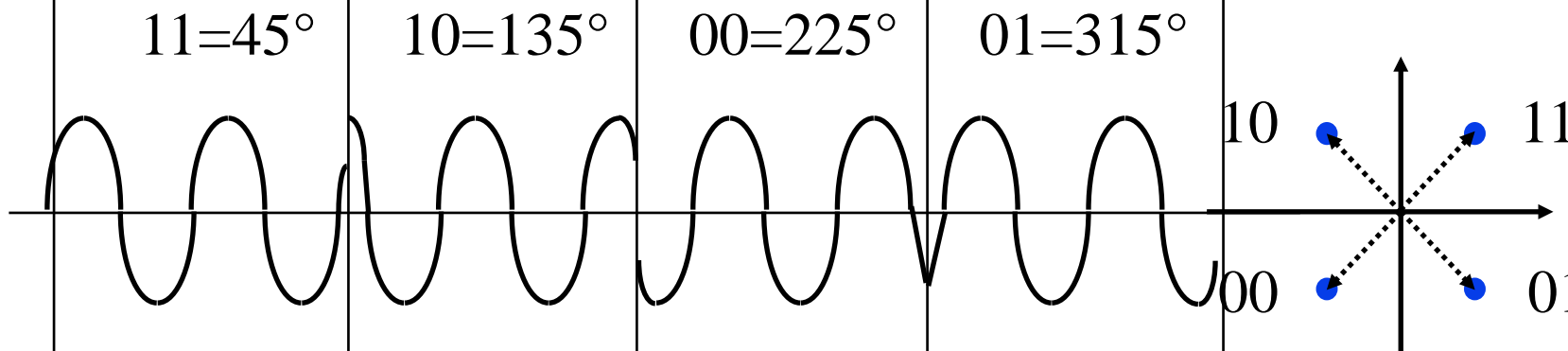

- ❑ In-phase (I) and Quadrature (Q) or 90° components are added

Ref: Electronic Design, "Understanding Modern Digital Modulation Techniques,"

<https://www.electronicdesign.com/communications/understanding-modern-digital-modulation-techniques>

<http://www.cse.wustl.edu/~jain/cse574-24/>

©2024 Raj Jain

Student Questions

- ❑ Since QPSK can represent 2 bits per symbol, while BPSK only represents 1 bit per symbol, does this mean that a signal using QPSK operates at a higher frequency?

No. There is only one frequency. The receiver has to be able to differentiate the phases.

QAM

- ❑ Quadrature Amplitude and Phase Modulation
- ❑ 4-QAM, 16-QAM, 64-QAM, 256-QAM
- ❑ Used in DSL and wireless networks

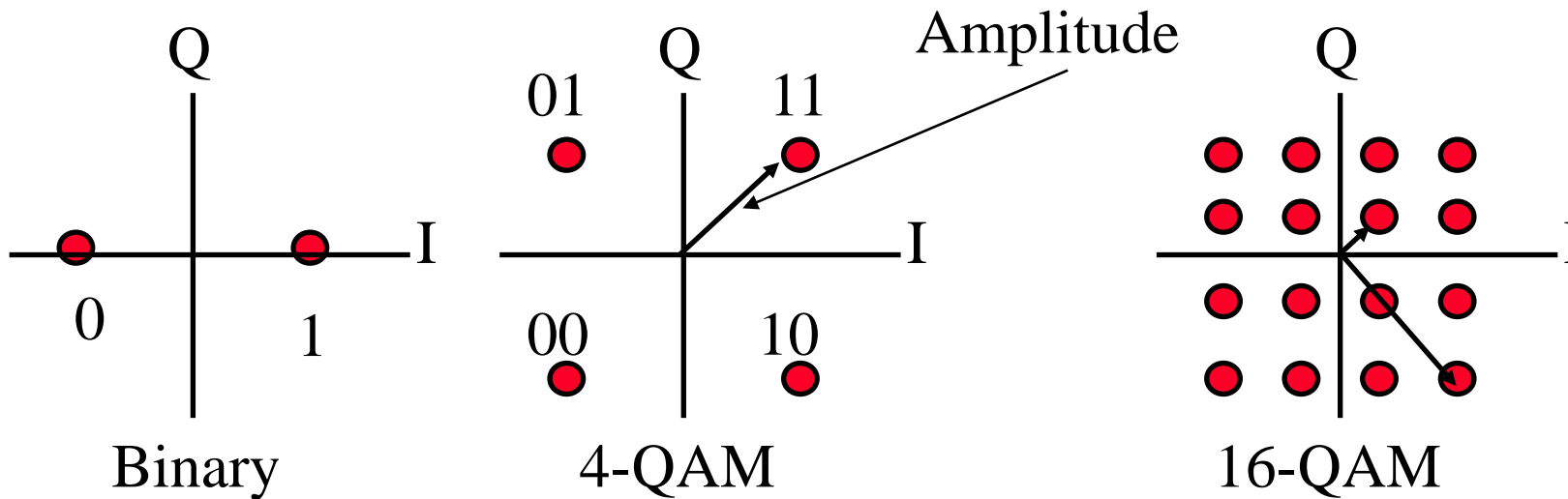

- ❑ 4-QAM \Rightarrow 2 bits/symbol, 16-QAM \Rightarrow 4 bits/symbol, ...

Student Questions

- ❑ Is QAM used in both wired and wireless networks?
Yes. QAM is very common in both wired and wireless networking.
- ❑ Is there a relationship between QAM, and ASK and QPSK modulation? and If QAM is an extension of QPSK, why the positions of 01 and 10 in QPSK are different from 4-QAM?

ASK uses only amplitude change. QAM uses both amplitude and phase as in 16-QAM shown. QPSK is same as 4-QAM.

- ❑ Are these graphs the result of Fourier transforms?
Yes, Fourier transforms are used to go from time domain to frequency domain and vice versa. EE students do all the math and design Layer 1. CS students work on Layer 2-7.

- ❑ How do we measure the amplitude in the figure?
By amplitude of the sine wave. All of this is done using Fourier transforms.

QAM

- ❑ Quadrature Amplitude and Phase Modulation
- ❑ 4-QAM, 16-QAM, 64-QAM, 256-QAM
- ❑ Used in DSL and wireless networks

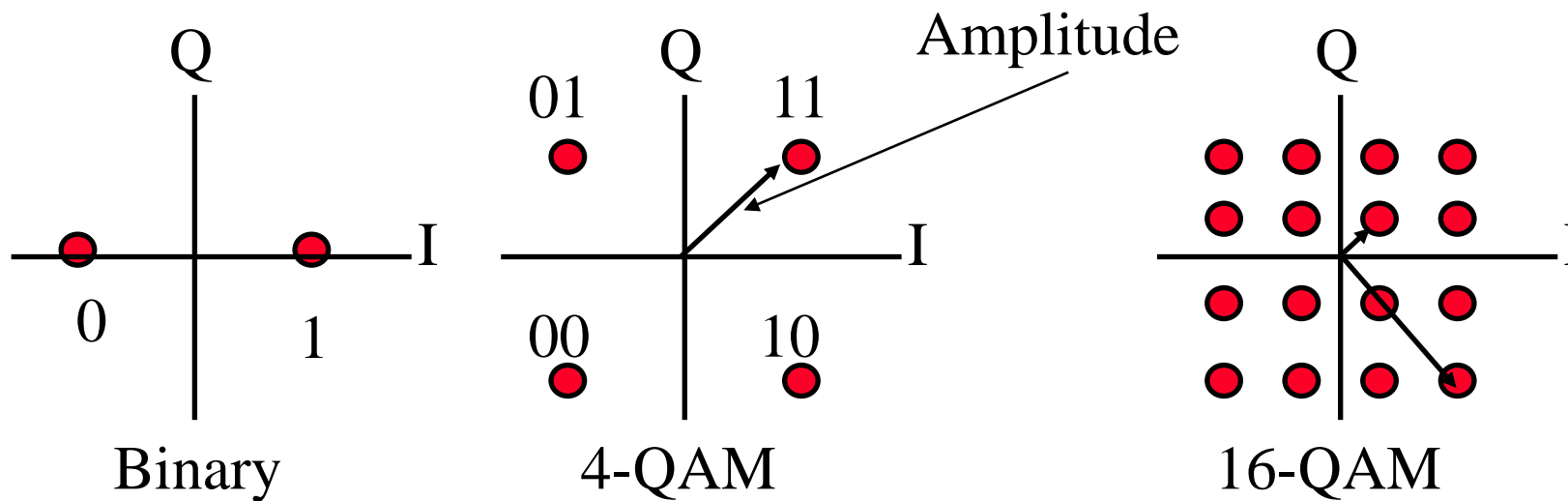

- ❑ 4-QAM \Rightarrow 2 bits/symbol, 16-QAM \Rightarrow 4 bits/symbol, ...

Student Questions

- ❑ What about 8-QAM?
Only even powers of 2 are used. This allows equal levels of the spread between phase and amplitude.
- ❑ Why do we need to change the amplitude?
For 16-QAM, we could increase the phase by 22.5 degrees for each code.
That would be phase modulation, not QAM.
- ❑ When you say bits/symbol, do you mean QAM rate?
*Rate = x/second
Bits/Symbol is not a rate. It is a ratio of bps and Baud.
"QAM rate" is a misnomer. The rate is independent of the modulation. You can send 16-QAM with a rate of 2/3, meaning you will first change 2 bits to three for error detection/correction.*

QAM

- ❑ Quadrature Amplitude and Phase Modulation
- ❑ 4-QAM, 16-QAM, 64-QAM, 256-QAM
- ❑ Used in DSL and wireless networks

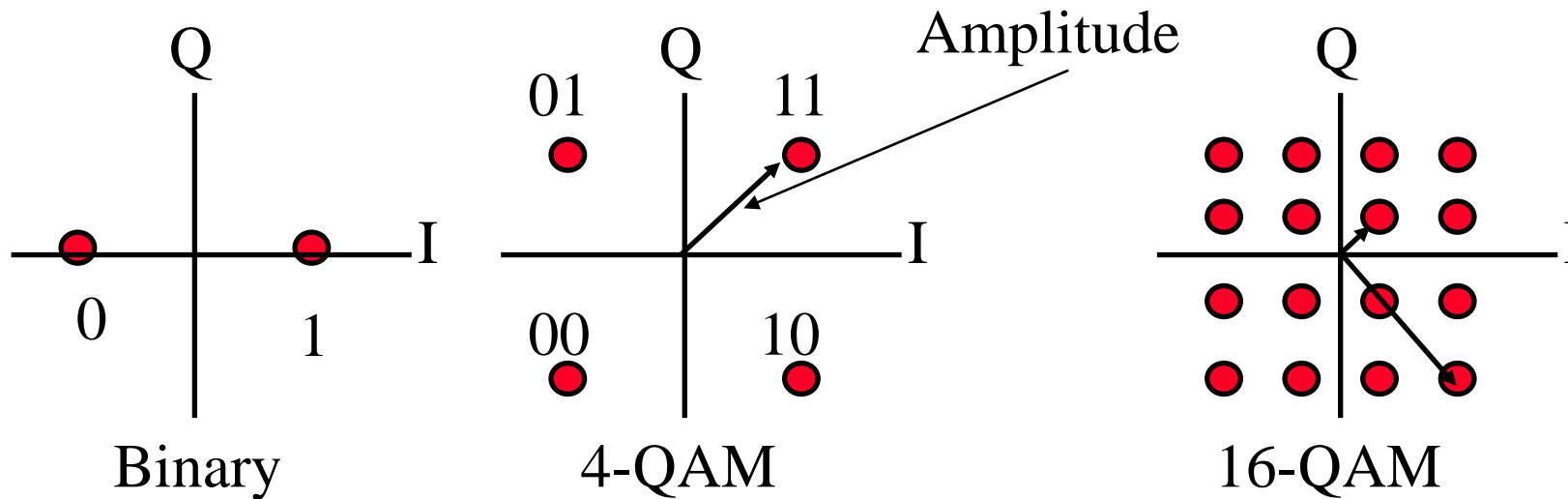

- ❑ 4-QAM \Rightarrow 2 bits/symbol, 16-QAM \Rightarrow 4 bits/symbol, ...

Student Questions

- ❑ What are the axes for QAM? I understand how it is a diagram of phase + amplitude, but I don't understand the labels Q and I.

Q = Quadrature = 90°

I = In phase = 0°

Channel Capacity

- Capacity = Maximum data rate for a channel
- Nyquist Theorem:** Bandwidth = B

$$\text{Data rate} \leq 2 B \times \log_2 M,$$

$$M = \text{Number of levels}$$
- Bi-level Encoding (M=2): $\text{Data rate} \leq 2 \times \text{Bandwidth}$

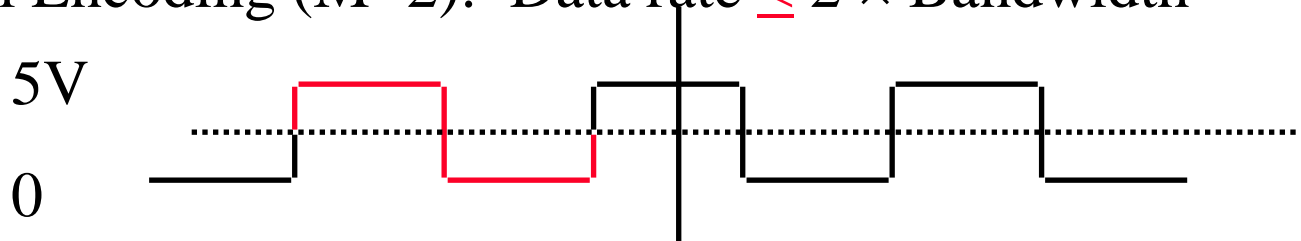

- Multilevel:

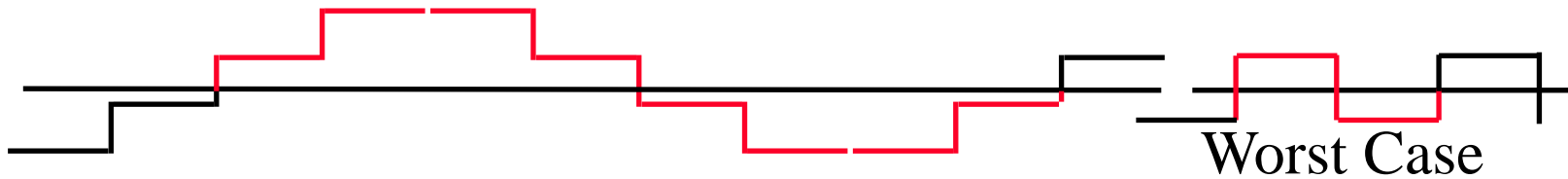

Example: M=4, Capacity = 4 × Bandwidth

Student Questions

- What does a level represent? A bit combination?
The level is the amplitude of the signal. The bottom left diagram has 4 levels -2, -1, 1, and 2. Other diagrams have only two levels -1, +1.
- Can you indicate the Baud length on the first diagram?
- In the first diagram, all elements have the same size. The red part indicates one cycle. If it is 1ms long, then each element is 0.5 ms and Baud rate is 2 kBaud.*
- When do the bit rate and Baud rate become equal?
When you use 1 bit/symbol.
- In the video, you said bit rate = 2 * Baud rate. Do you mean that Baud rate = bandwidth?
Bandwidth = Width of the frequency band used. Frequency is measured in Hertz. Bandwidth is measured in Hertz. Baud rate is measured in Bauds. Per second is implicit.
- I didn't understand what you mean by the worst case.
Consider all possible strings that one may want to send and the case that will result in the highest frequency.
- Can the worst case happen? In the worst case, you said that the bit rate is less or equal to 2B. If M=2, can the bit rate be 1.2 B?
If M=2, bps ≤ 2B. Yes, for some bit sequences (strings), it could be 1.2B. But it cannot be more than 2B. Yes, the worst case can happen. The worst case is the worst among all possible bit sequences.

Channel Capacity

□ Capacity = Maximum data rate for a channel

□ **Nyquist Theorem:** Bandwidth = B
Data rate $\leq 2 B \times \log_2 M$,
M = Number of levels

□ Bi-level Encoding (M=2): Data rate $\leq 2 \times$ Bandwidth

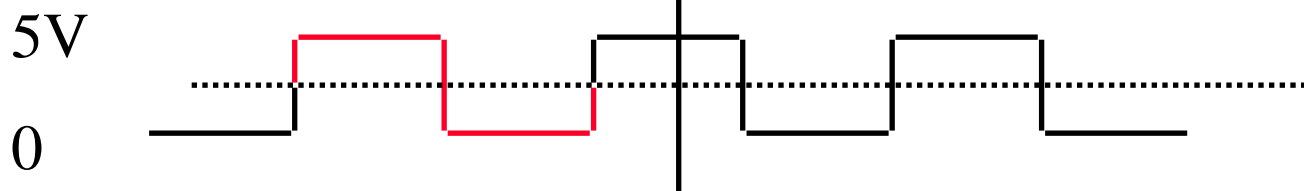

□ Multilevel:

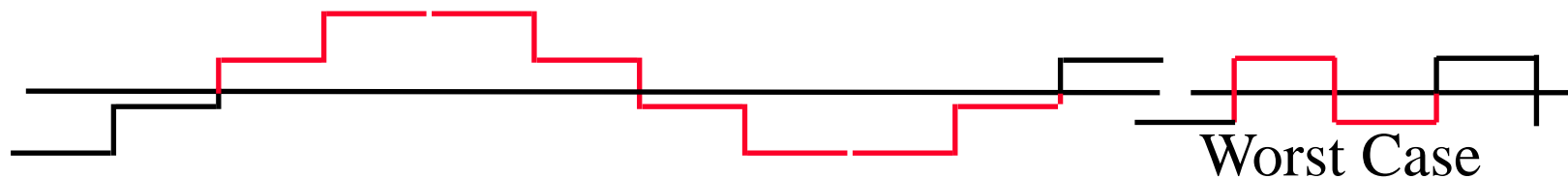

Example: M=4, Capacity = $4 \times$ Bandwidth

Student Questions

□ Why does the multilevel data rate equal $2 \times \text{bandwidth} \times \log_2 M$, not $4 \times \text{bandwidth} \times \log_2 M$?

Two come from the Nyquist theorem. You can change M if you want a higher rate.

❖ Is there any work being done for ternary instead of binary?

The powers of two are easy, as shown in the figure. Others are not worth the trouble.

□ Can you explain this slide again?

Sure.

❖ How does the level of a channel affect bits per second? Does each level represent a different bit?

Each level represents a different bit combination. For example, with 4-levels, each level represents two bits.

Channel Capacity

- Capacity = Maximum data rate for a channel
- Nyquist Theorem:** Bandwidth = B
Data rate $\leq 2 B \times \log_2 M$,
M = Number of levels
- Bi-level Encoding (M=2): Data rate $\leq 2 \times$ Bandwidth

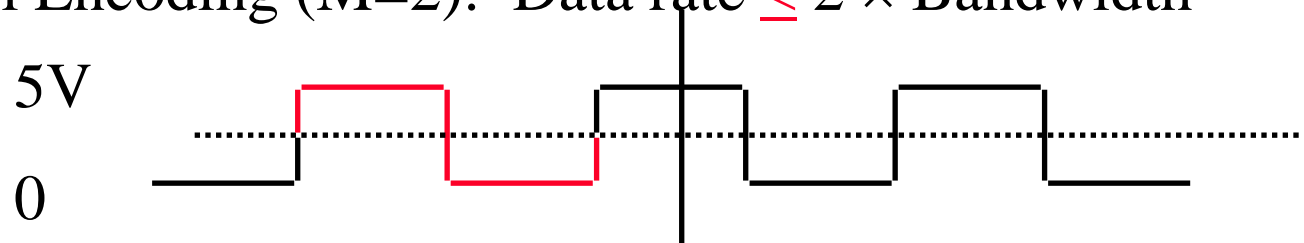

- Multilevel:

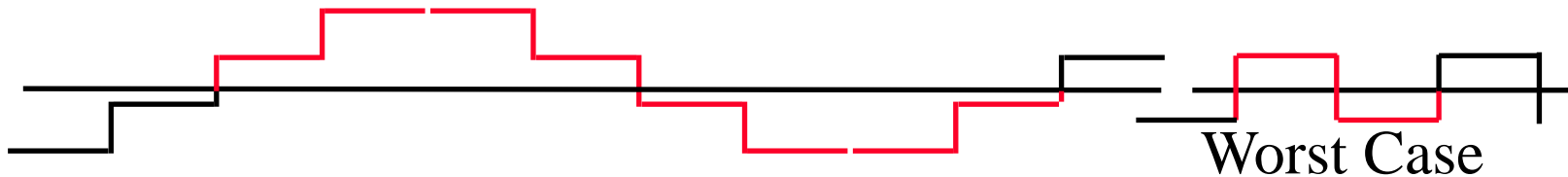

Example: M=4, Capacity = $4 \times$ Bandwidth

Student Questions

- ❖ The Nyquist Theorem indicates that the data rate must be less than or equal to twice the bandwidth. In the examples, the calculated data rate is always greater than or equal to the bandwidth. Which is correct?
 $x < 2y$ and $x > y$ can both be correct

Shannon's Theorem

- Bandwidth = B Hz
Signal-to-noise ratio = S/N ← In linear scale
- Maximum number of bits/sec = $B \log_2 (1+S/N)$
- Example: Phone wire bandwidth = 3100 Hz
 $S/N = 30 \text{ dB} \leftarrow \text{Log scale}$
 $10 \text{ Log}_{10} S/N = 30$
 $\text{Log}_{10} S/N = 3$
 $S/N = 10^3 = 1000 \leftarrow \text{In linear scale}$
Capacity = $3100 \log_2 (1+1000)$
 $= 30,894 \text{ bps}$

Student Questions

- What is the unit of the "S/N" when it is 1000? I know it is deciBel when it is 30.
Power is measured in Watts, mW, or micro-W. Watts can be added, subtracted, multiplied and divided. When converted to dB, the logs are only added or subtracted. dBs are not multiplied.
- My calculator calculated it to be 30898.4, I am not sure why it is different than your calculations.
My calculator is old. It used 32-bit real numbers and has only 4 digit precision.
- In the Shannon theorem, does the maximum data rate depend on channel type? How do we know we have achieved the maximum data rate on a specific media?
The maximum data rate depends upon the noise in the media. If you want a higher rate, change the noise level. Some media (e.g., electrical) has higher noise than others (e.g., optical).
- Can Shannon and Nyquist's theorems be combined? Are they two separate maxima for the data rate?
They are independent. One relates to noise. The other relates to coding. You need to find ways to reduce noise and ways to design better coding.

Shannon's Theorem

- Bandwidth = B Hz
Signal-to-noise ratio = S/N ← In linear scale
- Maximum number of bits/sec = $B \log_2 (1+S/N)$
- Example: Phone wire bandwidth = 3100 Hz
S/N = 30 dB ← Log scale
 $10 \log_{10} S/N = 30$
 $\log_{10} S/N = 3$
S/N = $10^3 = 1000$ ← In linear scale
Capacity = $3100 \log_2 (1+1000)$
= 30,894 bps

Student Questions

- You say that there can be three wires to denote three channels. How do we define channels in wireless?

Wireless Channel = Frequency Band = A range of frequency

Wi-Fi has 14 Channels, each 5 MHz wide:

Wi-Fi Ch1: 2412 MHz

Wi-Fi Ch2: 2417 MHz



Shannon's Theorem

- Bandwidth = B Hz
Signal-to-noise ratio = S/N ← In linear scale
- Maximum number of bits/sec = $B \log_2 (1+S/N)$
- Example: Phone wire bandwidth = 3100 Hz
S/N = 30 dB ← Log scale
 $10 \log_{10} S/N = 30$
 $\log_{10} S/N = 3$
S/N = $10^3 = 1000$ ← In linear scale
Capacity = $3100 \log_2 (1+1000)$
= 30,894 bps

Student Questions

- ❖ What is S/N being converted into before it is put into the equation?

Shannon's theorem uses Watts not dB.

- ❖ What's the formula for converting dB to Watts?

dB is a ratio, not Power. dB cannot be converted to Watts. dBm is the unit of power. If you take the ratio of power with 1mW, you get dBm.

$dBm = 10 \log_{10}(Power/1mW)$

Hamming Distance

□ Hamming Distance between two sequences
= Number of bits in which they disagree

□ Example: 011011
 110001

Difference 101010 \Rightarrow Distance = 3

Student Questions

Error Correction Example

- 2-bit words transmitted as 5-bit/word

<u>Data</u>	<u>Codeword</u>
00	00000
01	00111
10	11001
11	11110

Received = 00100 \Rightarrow Not one of the code words \Rightarrow Error

Distance (00100, 00000) = 1 Distance (00100, 00111) = 2

Distance (00100, 11001) = 4 Distance (00100, 11110) = 3

\Rightarrow Most likely, 00000 was sent. Corrected data = 00

b. Received = 01010 Distance(..., 00000) = 2 = Distance(..., 11110)

Error detected but cannot be corrected

c. Three-bit errors will not be detected. Sent 00000, Received 00111.

Student Questions

- Do we always use extended codewords to detect errors, or are there low-noise applications where we don't need to worry about error correction?

Yes, extra bits are required for error detection. Error correction requires even more extra bits.

- What is the *ratio* of the acceptable Hamming distance such that we can correct it? In our example, we had 5 bits, and you said we could correct up to 2-bit errors. I think it depends on the size and nature of code words.

Data bits and code bits are different. We have two data bits and five code bits. Yes, the detection and correction capabilities are determined by the coding, or nature of code words. Coding theory is still a research topic.

- What if the error was "11100"? Wouldn't that be detected?

No, because its distances from 10 and 11 are both 2.

Error Correction Example

- 2-bit words transmitted as 5-bit/word

<u>Data</u>	<u>Codeword</u>
00	00000
01	00111
10	11001
11	11110

Received = 00100 \Rightarrow Not one of the code words \Rightarrow Error

Distance (00100, 00000) = 1 Distance (00100, 00111) = 2

Distance (00100, 11001) = 4 Distance (00100, 11110) = 3

\Rightarrow Most likely, 00000 was sent. Corrected data = 00

b. Received = 01010 Distance(..., 00000) = 2 = Distance(..., 11110)

Error detected but cannot be corrected

c. Three-bit errors **may** not be detected. Sent 00000, Received 00111.

Student Questions

- As three-bits error will not be detected, how it is useful for error correction?

This code corrects one bit errors.

They are most likely. Probability of n bit errors is p^n , where p is the probability of one bit errors.

- What about 00000 error 11100, wouldn't that be detected but set to the wrong correct word.

11100 has a distance of 1 from 11 but a distance of 3 from 00. So it will be corrected to 11. The probability of 11100 from 11 is p and the probability of 11100 from 00 is p^3 , which is very small.

Multiple Access Methods



Time Division Multiple Access



Code Division Multiple Access

Student Questions

- How about FDMA (Frequency Division Multiple Access)?
Men and women have different frequencies. One person can talk to people with different frequencies and still be ok. But it isn't easy to show it in a picture without musical notes.

Frequency Hopping Spread Spectrum

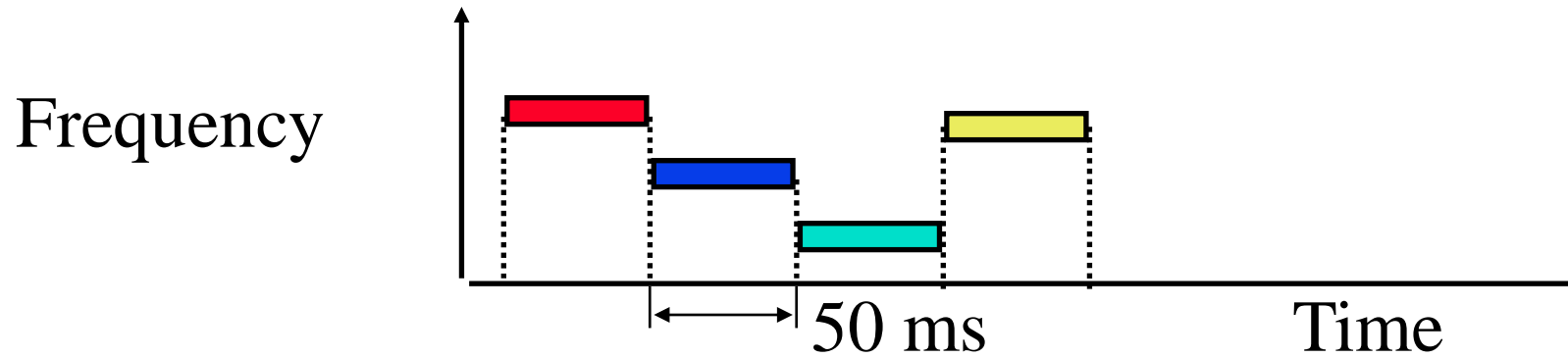

- ❑ Pseudo-random frequency hopping
- ❑ Spreads the power over a wide spectrum
⇒ Spread Spectrum
- ❑ Developed initially for military
- ❑ Patented by actress Hedy Lamarr
- ❑ Narrowband interference can't jam

Student Questions

- ❑ Do we then listen to each frequency for the same period of time (50ms for each frequency in this example)?
Yes, we tune to a different frequency every 50 ms.
- ❑ For the "seed" in the random number generator, is it random or a certain number like the current frequency?

It is generated by one party and sent to the other party during setup.

- ❑ In FHSS, do we use QAM for modulation and the selected frequency as the carrier?

Spreading and modulation are independent. You can use any spreading with any modulation.

- ❑ How does Frequency Hopping Spread Spectrum (FHSS) improve security in wireless communication?

If you don't know the random number generator, you cannot determine the next hop frequency.

Spectrum

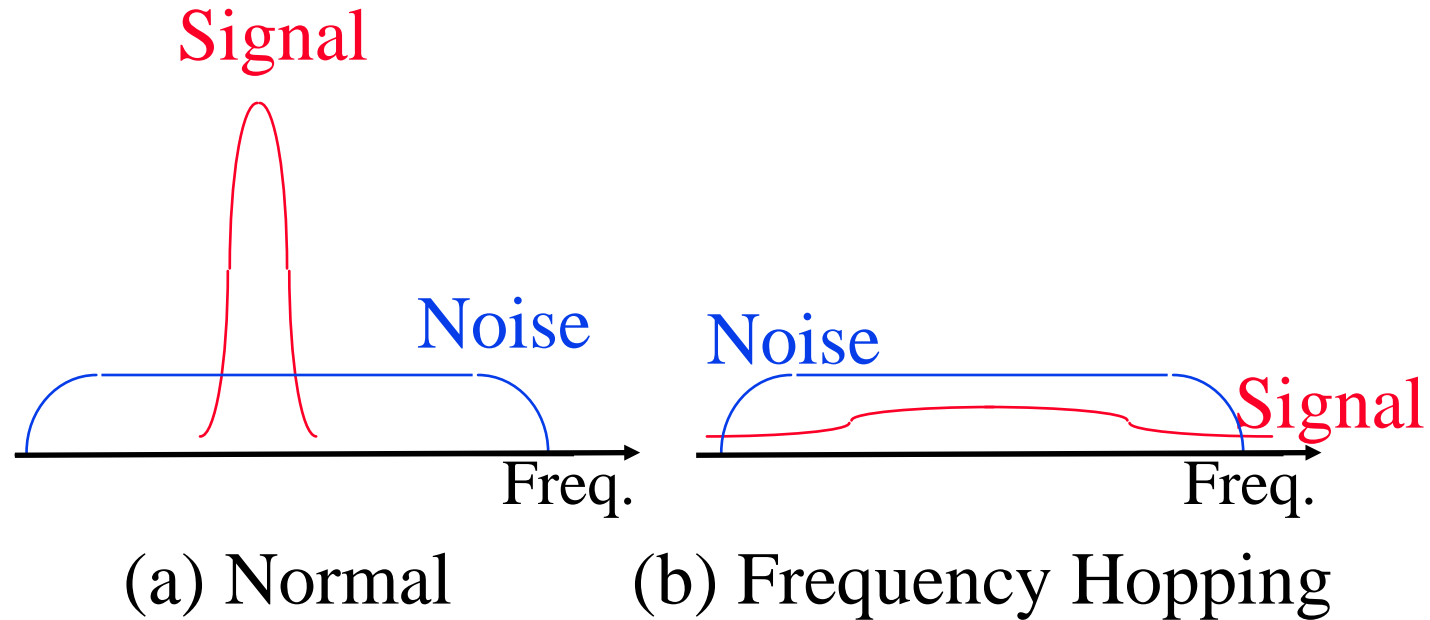

Student Questions

- Is there any daily situation where we use the normal spectrum?

Yes, that is the situation without frequency hopping.

- In Figure b, why the signal power is less than the noise? How could we distinguish our signal from background noise?

That's the beauty of frequency hopping. The signal is so random that the average signal becomes less than the average noise.

-
- Why is the signal below noise with frequency hopping?

Because the power is distributed over a large frequency band, the average power in any one frequency is very low.

Direct-Sequence Spread Spectrum

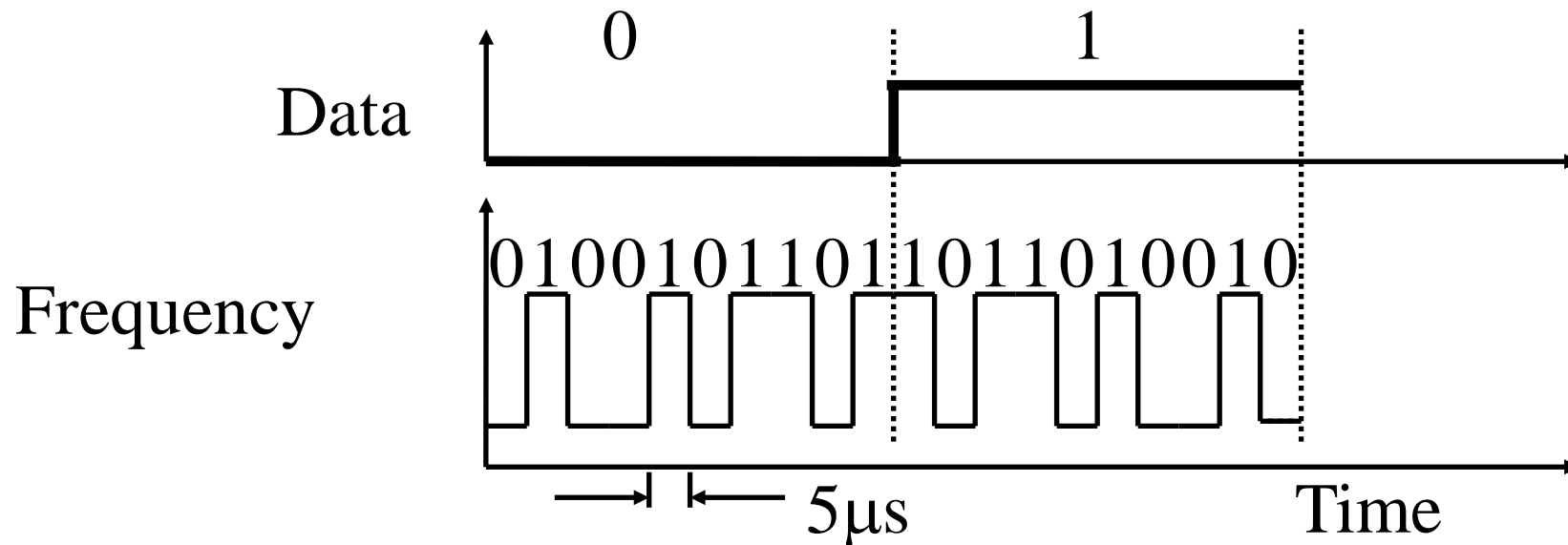

- ❑ Spreading factor = Code bits/data bit, 10-100 commercial (Min 10 by FCC), 10,000 for military
- ❑ Signal bandwidth $>10 \times$ data bandwidth
- ❑ Code sequence synchronization
- ❑ Correlation between codes \Rightarrow Interference Orthogonal

Student Questions

- ❑ Could you compare the DS spread spectrum with the frequency hopping spread spectrum?
In DSSS, frequency is high, but it is constant. In FHSS, frequency changes every element.
- ❑ If we reject the received code based solely on the pattern, what if it is directed to us with an error? How do we differentiate the error from noise?
Errors are caused by noise. If the coding cannot correct an error, the sequence is discarded, or other methods to correct it are used.
- ❑ If DSSS has code sequence synchronization, do we call the sync in FHSS - frequency synchronization?
In FHSS, seed exchange is implicit "frequency synchronization."
- ❑ The slide says there are 10 -100 code bits/data bits for commercial and 10,000 for the military. Does this mean the time to transmit a bit would be significantly longer for a military message than a commercial one?

Yes.

Direct-Sequence Spread Spectrum

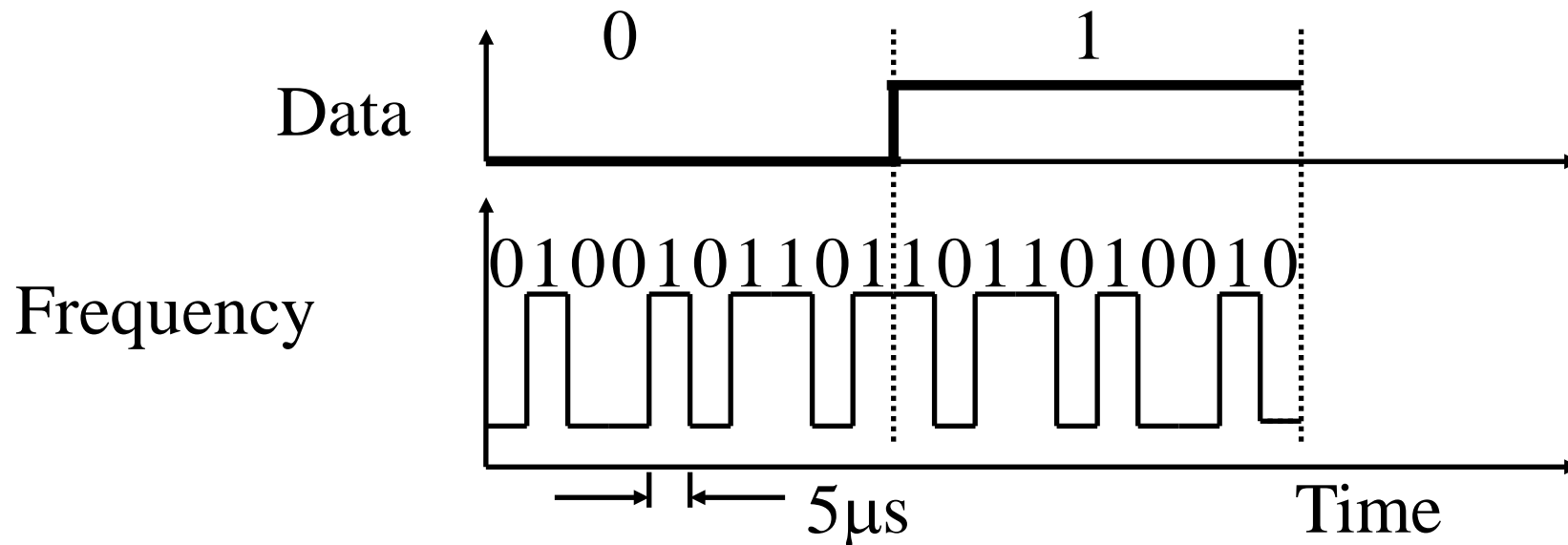

- ❑ Spreading factor = Code bits/data bit, 10-100 commercial (Min 10 by FCC), 10,000 for military
- ❑ Signal bandwidth $>10 \times$ data bandwidth
- ❑ Code sequence synchronization
- ❑ Correlation between codes \Rightarrow Interference Orthogonal

Student Questions

- ❖ So does the receiver listen to multiple frequencies at the same time, and if is 0 at one frequency and 1 in another at different times and that pattern matches then interpret it as a data bit?

No. The receiver listens at only one frequency—the current coding frequency, which is fixed at any one time but randomly varied after some interval.

DS Spectrum

Time Domain

Frequency Domain

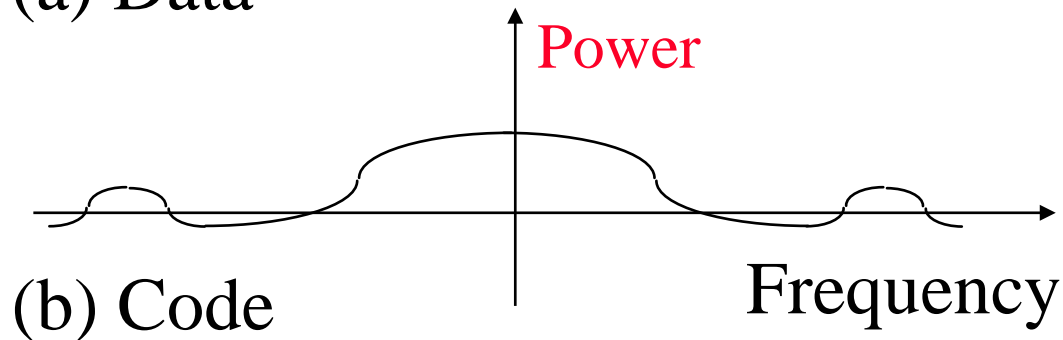
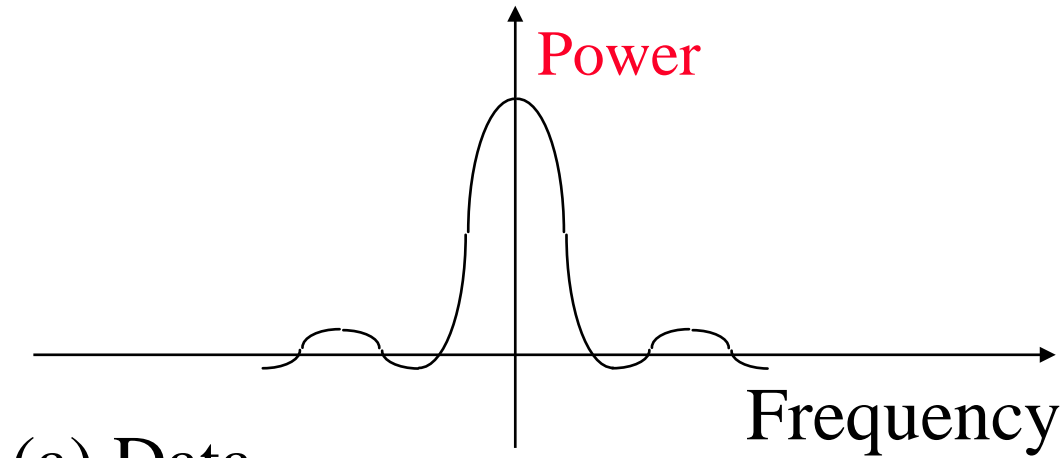
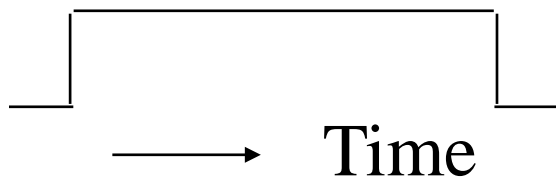

Student Questions

- ❖ What does the y-axis represent in the Frequency Domain graph?
In both domains, the y axis represents power.

Doppler Shift

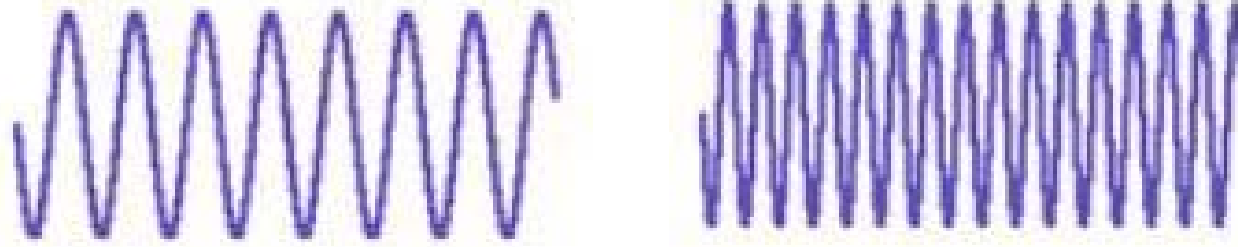

- ❑ If the transmitter or receiver or both are mobile, the frequency of the received signal changes
- ❑ Moving towards each other \Rightarrow Frequency increases
- ❑ Moving away from each other \Rightarrow Frequency decreases

$$\text{Frequency difference} = \text{Velocity/Wavelength} = v f / c$$

Example: $2.4 \text{ GHz} \Rightarrow \lambda = 3 \times 10^8 / 2.4 \times 10^9 = .125 \text{ m}$

$$120 \text{ km/hr} = 120 \times 1000 / 3600 = 33.3 \text{ m/s}$$

$$\text{Freq diff} = 33.3 / .125 = 267 \text{ Hz}$$

Student Questions

- ❑ In the example, "l" should be edited to indicate the wavelength " λ ".
Yes. You are right. PowerPoint often loses the font between copies.
- ❑ Does the velocity v mean the receiver velocity relative to the moving source?
Yes. The sum or difference of receiver and source velocity is used if both are moving.
- ❑ To calculate the wavelength, should we use emitted frequency or shifted frequency at the receiver?
Shifted frequency.

Doppler Spread and Coherence Time

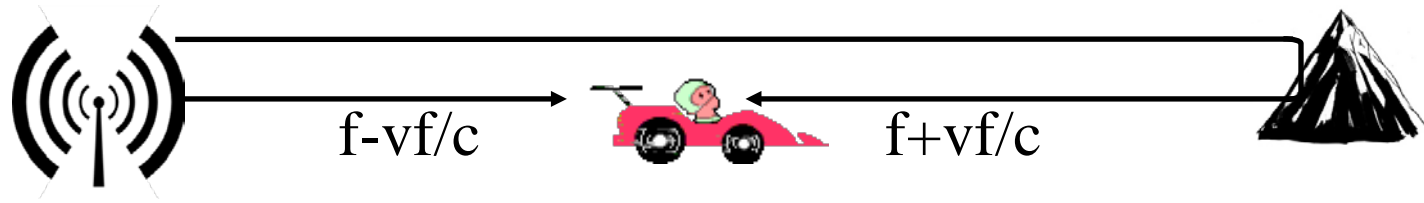

- ❑ Two rays will be received
- ❑ **Doppler Spread** = $2vf/c = 2 \times$ Doppler shift
- ❑ They will add or cancel out each other as the receiver moves
- ❑ **Coherence time**: Time during which the channel response is the same = $1/\text{Doppler spread}$

Student Questions

- ❑ Do the two rays switch between adding and canceling in a periodic way as the receiver moves?

Depending upon the phase, two signals can add or subtract. The two rays are at different frequencies. So analog computation would be pretty complicated. However, Fourier transforms make it easy.

- ❑ Will Doppler spread differ given different geographic areas, e.g., not two rays?
Yes. In general, there are many rays depending upon geography.

- ❑ Can you explain what constant channel response is again.
Channel response function determines the relationship between input and output signal.

$$\text{Signal}_{out} = H(\text{Signal}_{in})$$

Doppler Spread and Coherence Time

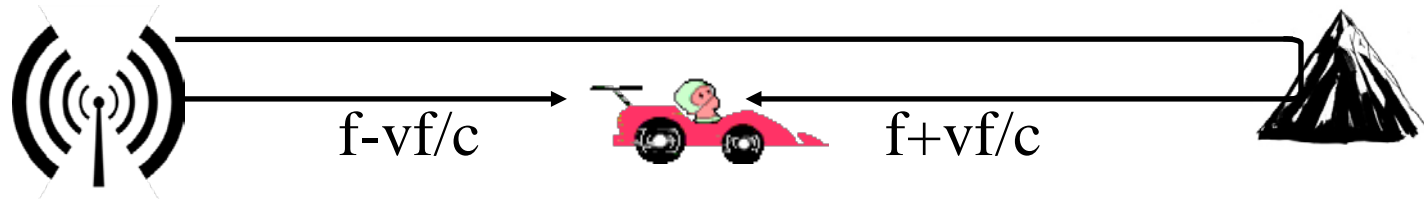

- ❑ Two rays will be received
- ❑ **Doppler Spread** = $2v f / c = 2 \times$ Doppler shift
- ❑ They will add or cancel out each other as the receiver moves
- ❑ **Coherence time**: Time during which the channel response response is the same = $1/\text{Doppler spread}$

Student Questions

❖ What does channel response is constant mean?

The channel is modeled by a formula. That formula remains constant during coherence time.

Duplexing

- ❑ Duplex = Bi-Directional Communication
- ❑ Frequency division duplexing (FDD) (Full-Duplex)

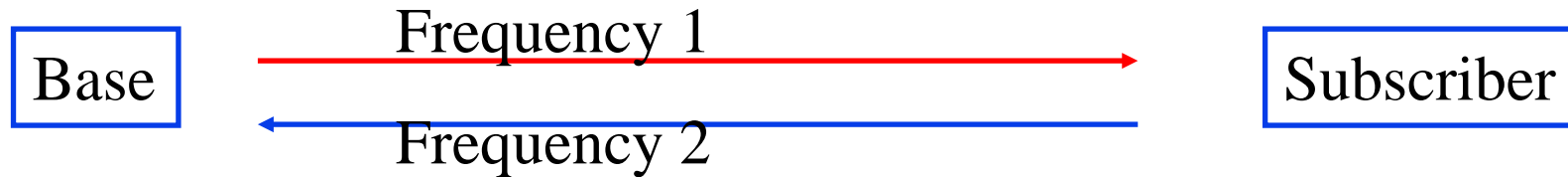

- ❑ Time division duplex (TDD): Half-duplex

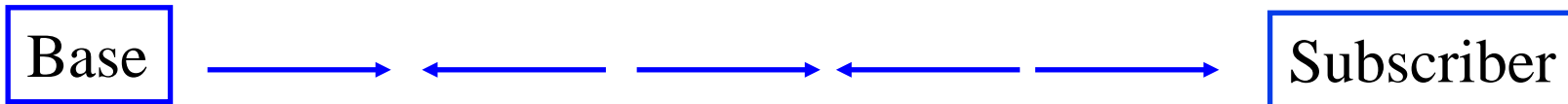

- ❑ Many LTE deployments will use TDD.
 - Allows more flexible sharing of DL/UL data rate
 - Does not require paired spectrum
 - Easy channel estimation \Rightarrow Simpler transceiver design
 - Con: All neighboring BS should time synchronize

Student Questions

- ❑ Does half duplex mean only one frequency go and come?

It is about the direction. In half-duplex, only one side at a time can transmit. Depending upon the coding, one or more frequency may be used even in one bit.

- ❑ With TDD, does the time interval stay the same once it is decided? For example, if the interval between sending and receiving is set to 50s, does it always stay the same, or can it change on the go?

You can change it on the go. It is the system designer's choice.

- ❖ Why is TDD more flexible for sharing DL/UL data rates?

It is easy to dynamically change time allocations for DL vs. UL compared to frequency allocations.

- ❖ I wonder why TDD is more popular than FDD as FDD enables full-duplex communication, i.e., simultaneous transmission and reception, whereas TDD is only half-duplex.

TDD allows using the entire band. FDD divides the band. It is a tradeoff.

Duplexing

- ❑ Duplex = Bi-Directional Communication
- ❑ Frequency division duplexing (FDD) (Full-Duplex)

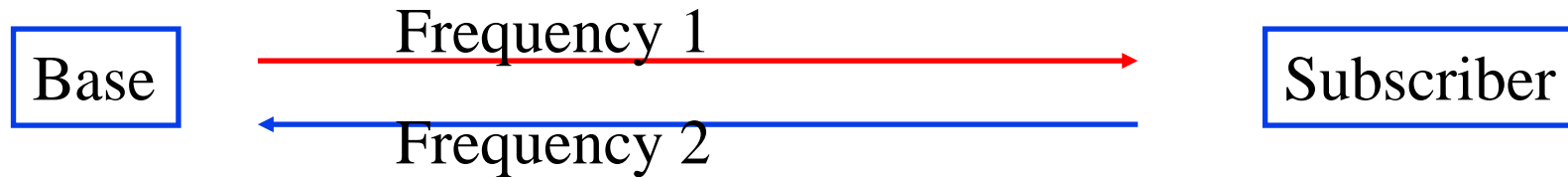

- ❑ Time division duplex (TDD): Half-duplex

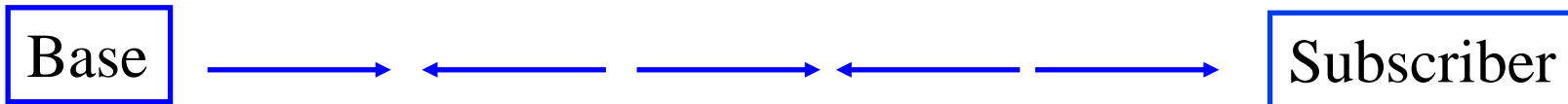

- ❑ Many LTE deployments will use TDD.
 - Allows more flexible sharing of DL/UL data rate
 - Does not require paired spectrum
 - Easy channel estimation \Rightarrow Simpler transceiver design
 - Con: All neighboring BS should time synchronize

Student Questions

- ❑ For TDD in calling, is the time slice changing the data direction so quickly that we cannot notice any interruption in the voice?
No. You speak, stop, listen. E.g., in this class, two people must not speak together.

Summary

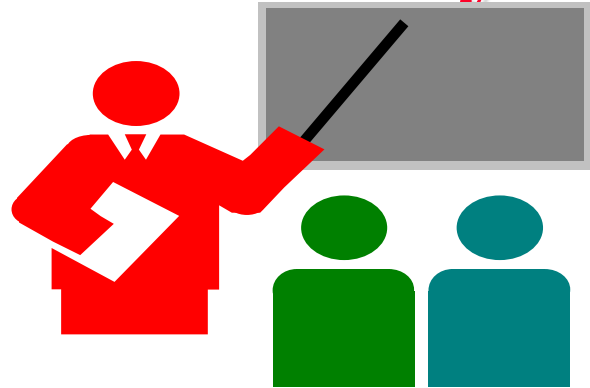

1. Electric, Radio, Light, and X-Rays, are all electromagnetic waves
2. Wireless radio waves travel at the speed of light, $300 \text{ m}/\mu\text{s}$
Wavelength $\lambda = c/f$
3. 16-QAM uses 16 combinations of amplitude and phase using 4 bits per symbol.
4. Hertz and Bit rate are related by Nyquist and Shannon's Theorems
5. Frequency hopping and Direct Sequence are two methods of code division multiple access (CDMA).

Student Questions

Homework 3

- A. What is the wavelength of a signal at 60 GHz?
- B. How many Watts of power is 30dBm?
- C. A telephone line is known to have a loss of 20 dB. The input signal power is measured at 1 Watt, and the output signal noise level is measured at one mW. Using this information, calculate the output signal-to-noise ratio in dB.
- D. What is the maximum data rate that can be supported on a 10 MHz noise-less channel if the channel uses eight-level digital signals?
- E. What signal-to-noise ratio (in dB) is required to achieve 10 Mbps through a 5 MHz channel?
- F. Compute the average Doppler frequency shift at 36 km/hr using a 3-GHz band. Doppler spread is twice the Doppler shift. What is the channel coherence time?

Student Questions

- On Slide 9: Do you mean the total system loss by attenuation? This includes adding the wire loss and noise at the receiver.

Attenuation is the “power loss” across the measurement points. Noise may not reduce power. In Part C, you need to compute the output power given the input power and attenuation. Then compare it with noise to get the SNR.

- Do you need just the final answers or full solutions.?

50% marks for the method and 50% for a final answer in all homework that requires computation.

-
- What is the attenuation we should assume for HW3 Q2 to find the watts of power?

There is no need for attenuation. You are given dBm and need to convert it to Watts. Both are units of power.

Reading List

- ❑ Electronic Design, “Understanding Modern Digital Modulation Techniques,”
<https://www.electronicdesign.com/communications/understanding-modern-digital-modulation-techniques>
- ❑ Jim Geier, "Designing and Deploying 802.11 Wireless Networks: A Practical Guide to Implementing 802.11n and 802.11ac Wireless Networks, Second Edition," Cisco Press, May 2015, 600 pp., ISBN:1-58714-430-1 (Safari Book), Chapter 2.
- ❑ Jim Geier, "Wireless Networks first-step," Cisco Press, August 2004, 264 pp., ISBN:1-58720-111-9 (Safari Book), Chapter 3.
- ❑ Steve Rackley, “Wireless Networking Technology," Newnes, March 2007, 416 pp., ISBN:0-7506-6788-5 (Safari Book), Chapter 4.

Student Questions

Wikipedia Links

- ❑ <https://en.wikipedia.org/wiki/Frequency>
- ❑ <https://en.wikipedia.org/wiki/Wavelength>
- ❑ [https://en.wikipedia.org/wiki/Phase_\(waves\)](https://en.wikipedia.org/wiki/Phase_(waves))
- ❑ https://en.wikipedia.org/wiki/Quadrature_phase
- ❑ https://en.wikipedia.org/wiki/Frequency_domain
- ❑ https://en.wikipedia.org/wiki/Time_domain
- ❑ https://en.wikipedia.org/wiki/Fourier_transform
- ❑ https://en.wikipedia.org/wiki/Electromagnetic_spectrum
- ❑ <https://en.wikipedia.org/wiki/Decibel>
- ❑ <https://en.wikipedia.org/wiki/DBm>
- ❑ <https://en.wikipedia.org/wiki/Modulation>
- ❑ https://en.wikipedia.org/wiki/Amplitude-shift_keying
- ❑ https://en.wikipedia.org/wiki/Phase-shift_keying
- ❑ https://en.wikipedia.org/wiki/Frequency-shift_keying
- ❑ https://en.wikipedia.org/wiki/Quadrature_phase-shift_keying

Student Questions

Wikipedia Links (Cont)

- ❑ https://en.wikipedia.org/wiki/Differential_coding
- ❑ https://en.wikipedia.org/wiki/Quadrature_amplitude_modulation
- ❑ https://en.wikipedia.org/wiki/Shannon%E2%80%93Hartley_theorem
- ❑ https://en.wikipedia.org/wiki/Channel_capacity
- ❑ https://en.wikipedia.org/wiki/Hamming_distance
- ❑ https://en.wikipedia.org/wiki/Channel_access_method
- ❑ https://en.wikipedia.org/wiki/Time_division_multiple_access
- ❑ https://en.wikipedia.org/wiki/Frequency-division_multiple_access
- ❑ <https://en.wikipedia.org/wiki/CDMA>
- ❑ https://en.wikipedia.org/wiki/Spread_spectrum
- ❑ https://en.wikipedia.org/wiki/Direct-sequence_spread_spectrum
- ❑ https://en.wikipedia.org/wiki/Frequency-hopping_spread_spectrum
- ❑ https://en.wikipedia.org/wiki/Doppler_effect
- ❑ [https://en.wikipedia.org/wiki/Duplex_\(telecommunications\)](https://en.wikipedia.org/wiki/Duplex_(telecommunications))
- ❑ https://en.wikipedia.org/wiki/Time-division_duplex
- ❑ http://en.wikipedia.org/wiki/Frequency_division_duplex

Student Questions

Optional Listening Material

Those not familiar with modulation, coding, CRC, etc may want to listen to the following lectures from CSE473S:

- ❑ Transmission Media,
http://www.cse.wustl.edu/~jain/cse473-11/i_1cni.htm
- ❑ Signal Encoding Techniques,
http://www.cse.wustl.edu/~jain/cse473-05/i_5cod.htm
- ❑ Digital Communications Techniques,
http://www.cse.wustl.edu/~jain/cse473-05/i_6com.htm

Student Questions

Acronyms

- ❑ ASK Amplitude Shift Keying
- ❑ BPSK Binary Phase Shift Keying
- ❑ BS Base Station
- ❑ CDMA Code division multiple access
- ❑ CRC Cyclic Redundancy Check
- ❑ dB Decibel
- ❑ dBm Decibel milliWatt
- ❑ DL Downlink
- ❑ DS Direct Sequence
- ❑ DSL Digital Subscriber Line
- ❑ FCC Federal Communications Commission
- ❑ FDD Frequency Division Duplexing
- ❑ FSK Frequency Shift Keying
- ❑ GHz Giga Hertz
- ❑ LAN Local Area Network
- ❑ MHz Mega Hertz

Student Questions

Acronyms (Cont)

- ❑ mW milli Watt
- ❑ OFDM Orthogonal Frequency Division Multiplexing
- ❑ PSK Phase Shift Keying
- ❑ QAM Quadrature Amplitude Modulation
- ❑ QPSK Quadrature Phase Shift Keying
- ❑ SS Subscriber Station
- ❑ TDD Time Division Duplexing
- ❑ UL Uplink

Student Questions

Scan This to Download These Slides



Raj Jain

<http://rajjain.com>

Student Questions

http://www.cse.wustl.edu/~jain/cse574-24/j_03phy.htm

Related Modules



CSE567M: Computer Systems Analysis (Spring 2013),
https://www.youtube.com/playlist?list=PLjGG94etKypJEKjNAa1n_1X0bWWNyZcof

CSE473S: Introduction to Computer Networks (Fall 2011),
https://www.youtube.com/playlist?list=PLjGG94etKypJWOSPMh8Azcg5e_10TiDw



Advances in Networking (Spring 2013),
<https://www.youtube.com/playlist?list=PLjGG94etKypLHyBN8mOgwJLHD2FFIMGq5>

CSE571S: Network Security (Fall 2011),
<https://www.youtube.com/playlist?list=PLjGG94etKypKvzfVtutHcPFJXumyyg93u>



Video Podcasts of Prof. Raj Jain's Lectures,
<https://www.youtube.com/channel/UCN4-5wzNP9-ruOzQMs-8NUw>

Student Questions