

Introduction to Cellular Networks: 1G/2G/3G

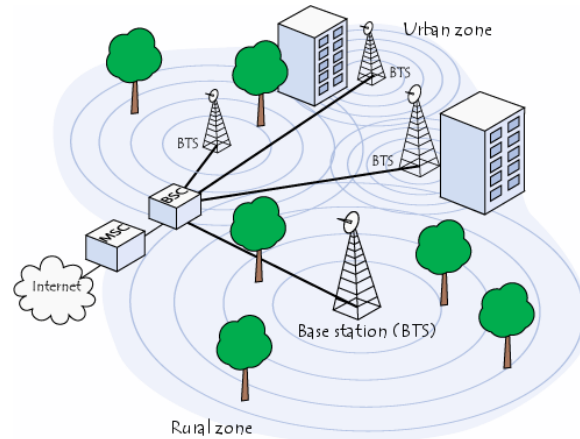

Raj Jain

Washington University in Saint Louis

Saint Louis, MO 63130

Jain@cse.wustl.edu

Audio/Video recordings of this class lecture are available at:

<http://www.cse.wustl.edu/~jain/cse574-24/>

Student Questions



1. Cellular Telephony
2. Cellular Frequency Reuse
3. 2G: GSM
4. 2.5G: GPRS, EDGE
5. 3G: W-CDMA
6. 3.5G: High-Speed Packet Access (HSPA)

Note: This is the 1st lecture in a series of lectures on 1G to 5G. 4G, 4.5G, and 5G are covered in subsequent modules.

Student Questions

Cellular Network Beginnings

- ❑ AT&T Bell Labs designed a cellular structure to reuse frequency. No two adjacent cells use the same frequency.
- ❑ 1977: FCC authorized two commercial deployments
 - Chicago: Illinois Bell
 - Washington, DC: American Radiotelephone Service
 - Both services started in 1983

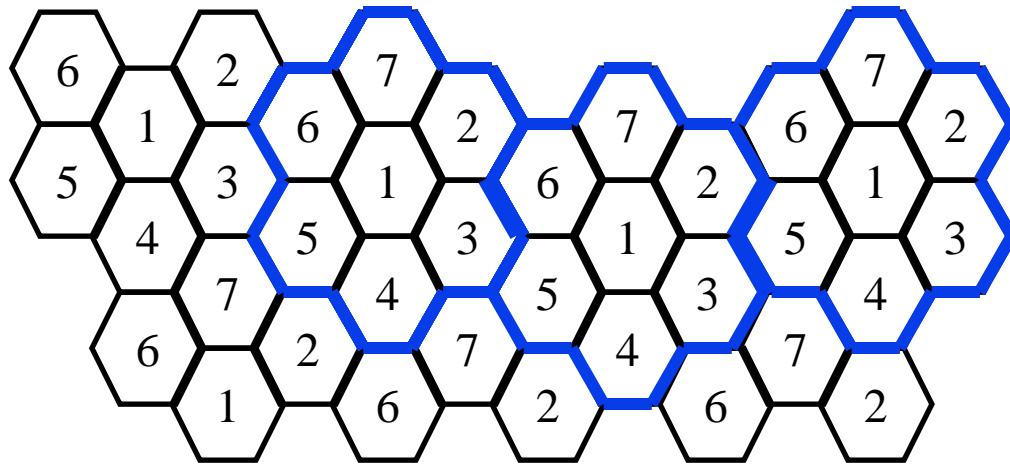

Student Questions

- ❑ Were they cells actually hexagonal? Why was that shape chosen?

In theory, any shape close to a circle will work. Pentagon and hexagon are closer to a circle than a square.

Hexagon is easier to draw than pentagon.

In practice, a survey is done to find the contours that have the same signal strength. These contours are not circular or hexagonal.

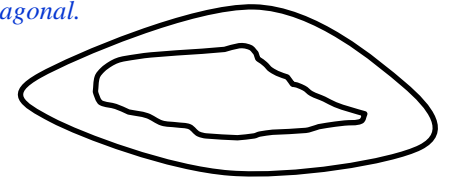

Initial Cellular System in US

- ❑ US was divided into
 - 306 metropolitan service areas (MSAs)
75% of the US population, 20% of the area
Densely populated \Rightarrow Small cell size
 - 428 rural service areas (RSAs)
Less populated \Rightarrow Larger cell size
- ❑ Each area was initially allowed two competing carriers: A, B
 - Bell (B)
 - Alternative (A)
- ❑ 832 channel pairs in each area. 416 pairs per carrier.
45 MHz between transmit and receive frequencies
30 kHz per channel
1:7 Frequency reuse with hexagonal cells
- ❑ Too many applicants \Rightarrow FCC started a lottery system
- ❑ At least one system in every market by 1990

Student Questions

- ❑ 1. What does it mean by larger cell size? Is it bigger hexagon sizes?

Yes.

- ❑ 2. What is the advantage of small cell? Would the speed be faster?

Yes.

- ❑ Why is the frequency reuse limited to hexagonal cells? Is there a downside to having too many sides?

No. See contour discussion on the previous slide.

- ❑ Does the 3rd bullet mean that the TX and RX frequencies are 45MHz apart?

Yes.

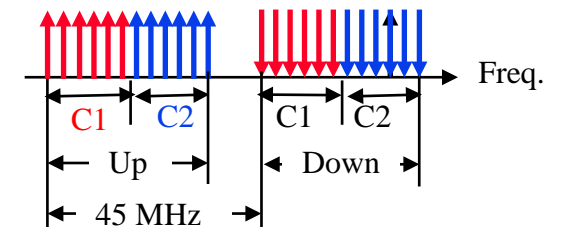

Cell Sites

- ❑ On towers, rooftops, water tanks, utility poles, ...
 - Good source of income for utility companies, cities, schools, churches, hotels, ...
 - With a base station for electronics
 - NIMBY (Not in my backyard)
 - ⇒ Mostly hidden, shared towers



Student Questions

- ❑ What is the effect of having a nearby BTS on our health?

This is a point of debate.

Cells on Wheels (CoWs)

- ❑ Used for a temporary surge in traffic, e.g., games, fares, ...

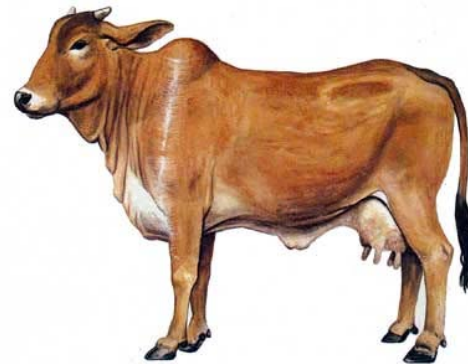

Student Questions

- ❑ Whenever I am in a very crowded place, my cell phone loses signal. What is happening here? Is my signal lost due to interference between other devices, or is this simply caused by a overloaded cell tower?

Both interference and tower overload can result in timeouts.

- ❑ Do we have mobile cells today?

Yes.

Macro, Micro, Pico, Femto Cells

- ❑ Macro: Sections of a city, more than a 1 km radius
- ❑ Micro: Neighborhoods, less than 1 km
- ❑ Pico: Busy public areas: Malls, airports, ..., 200 m
- ❑ Femto: Inside a home, 10 m

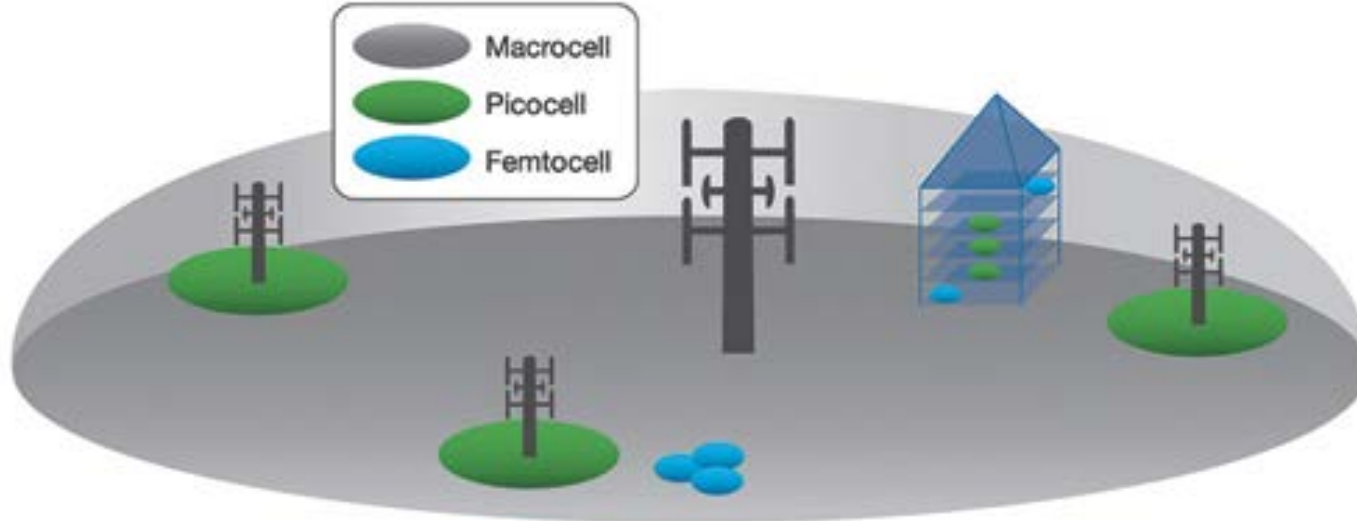

Student Questions

Ref: <http://www.microwavejournal.com/articles/print/22784-high-efficiency-amplifier-for-picocells>

Washington University in St. Louis

<http://www.cse.wustl.edu/~jain/cse574-24/>

©2024 Raj Jain

Cellular Frequency Reuse

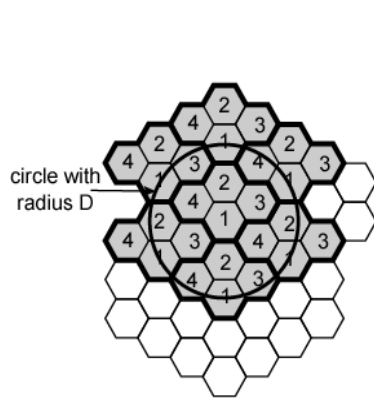

Cluster Size = 4

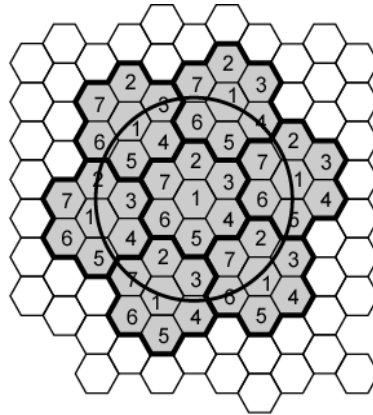

Cluster Size = 7

(a) Frequency reuse pattern for $N = 4$

(b) Frequency reuse pattern for $N = 7$

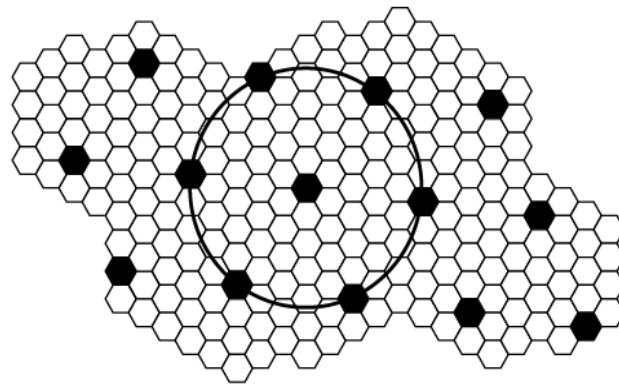

Cluster Size = 19

(c) Black cells indicate a frequency reuse for $N = 19$

Student Questions

Characterizing Frequency Reuse

- ❑ D = minimum distance between centers of cells that use the same band of frequencies (called co-channels)
- ❑ R = radius of a cell
- ❑ d = distance between centers of adjacent cells ($d = R\sqrt{3}$)
- ❑ N = number of cells in repetitious pattern (**Cluster**)
 - Reuse factor
 - Each cell in the pattern uses a unique band of frequencies
- ❑ Hexagonal cell pattern, following values of N possible
 - $N = I^2 + J^2 + (I \times J)$, $I, J = 0, 1, 2, 3, \dots$
- ❑ Possible values of N are 1, 3, 4, 7, 9, 12, 13, 16, 19, 21, ...
- ❑ Reuse Ratio = Distance/Radius = $D/R = \sqrt{3N}$
- ❑ $D/d = \sqrt{3N}$

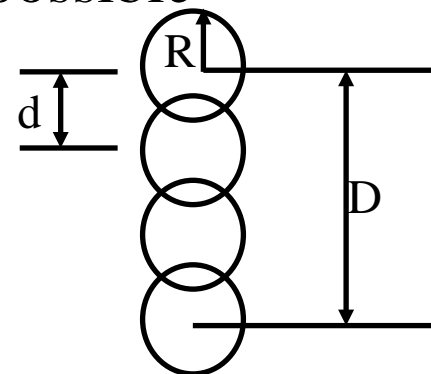

Ref: C. Siva Ram Murthy; B. S. Manoj, "Ad Hoc Wireless Networks Architectures and Protocols," Prentice Hall, 2004, ISBN: 013147023X, 880 pp., Safari Book, Section 3.2.

Washington University in St. Louis

<http://www.cse.wustl.edu/~jain/cse574-24/>

©2024 Raj Jain

Student Questions

- ❑ Does N refers to the size of the cluster?
Yes, see the previous slide.
- ❑ What does the radius refer to since the cells are hexagonal? Is it the inscribed radius or the circumscribed radius?
Circumscribed radius.

Frequency Reuse Example

What would be the minimum distance between the centers of two cells with the same band of frequencies if the cell radius is 1 km and the reuse factor is 12?

$$D/R = \sqrt{3N}$$

$$\begin{aligned} D &= (3 \times 12)^{1/2} \times 1 \text{ km} \\ &= 6 \text{ km} \end{aligned}$$

Student Questions

Homework 16A

- The distance between cell centers with the same frequency band is required to be more than 6 km. What is the cell radius for the cluster size of 12?

Student Questions

Frequency Reuse Notation

- $N \times S \times K$ frequency reuse pattern
- N = Number of cells per cluster
- S = Number of sectors in a cell
- K = Number of frequency allocations per cell

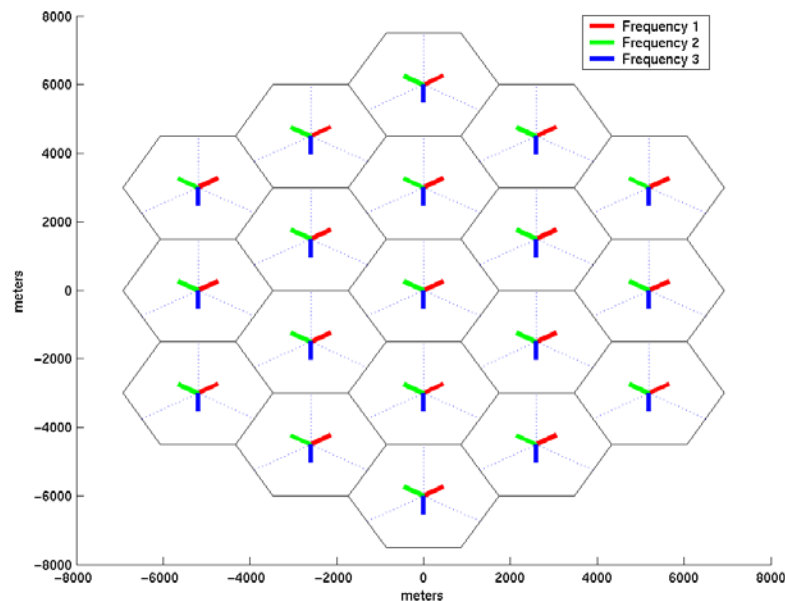

1X3X3

Student Questions

- What is cluster? Is it small hexagon in this figure?
The cluster is a group of hexagons. The same frequency reuse pattern is repeated in each cluster. The next slides shows some clusters with more than one hexagon in one cluster.

Frequency Reuse Notation (Cont)

1x3x1

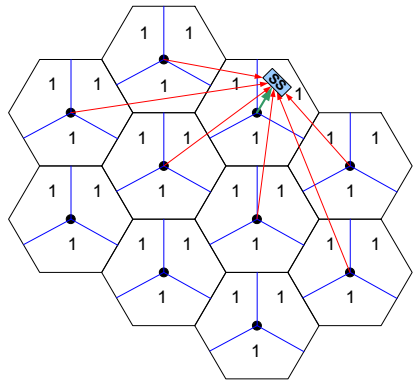

1x3x3

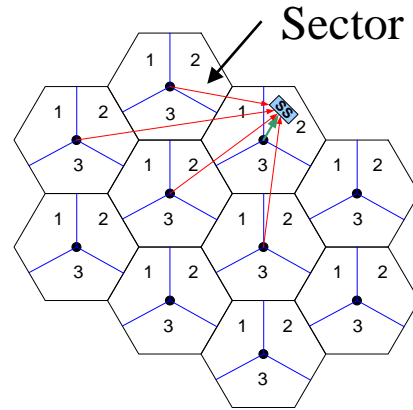

1x1x1

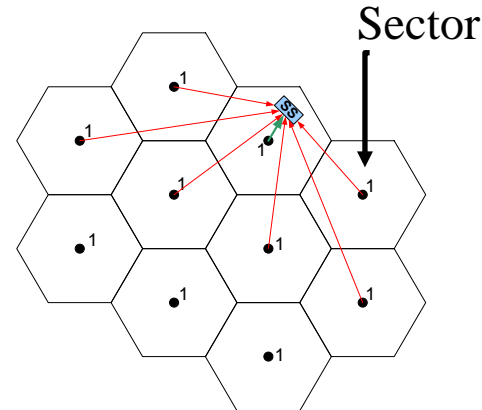

3x1x1

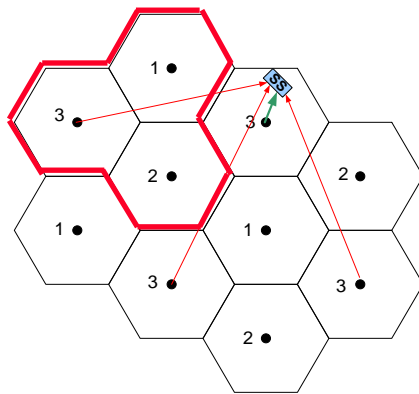

3x3x1

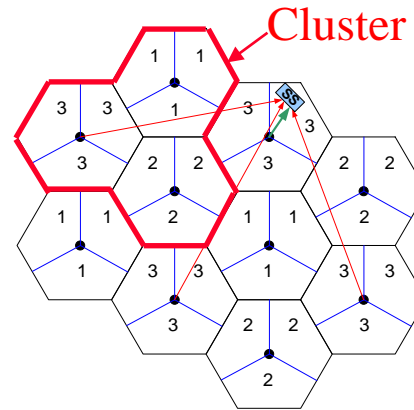

3x3x3

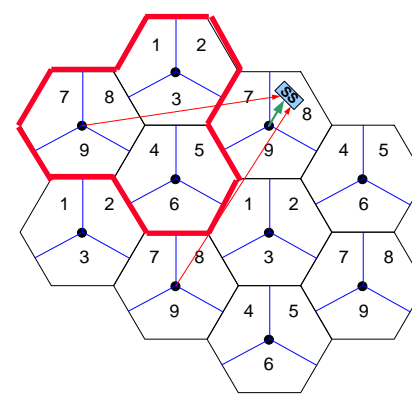

Student Questions

- ❑ "What would 1x1x3 look like?"

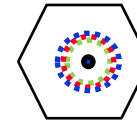

- ❑ What does the sector represent?
Sector is a part of the cell. One tower can serve many sectors (generally in many directions. The top right figure has one sector per cell. While the bottom right has 3 sectors/cell.

- ❑ In 3x3x3, can we use 1, 2, 3, 1, 2, 3, 1, 2, 3 frequency rather than 1-9 in one cluster?

No. In a 3x3x3, the cluster size is 3. You can not repeat any frequency in the cells inside the cluster.

- ❑ If not, does it mean we cannot use the same frequency in a different cell in one cluster?
Yes, each cell in a cluster must have a different frequency.

Frequency Reuse Notation (Cont)

Sector
↓

1x3x1

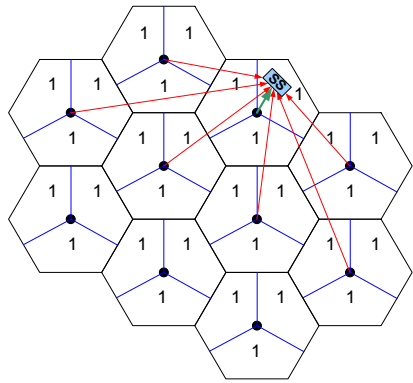

1x3x3

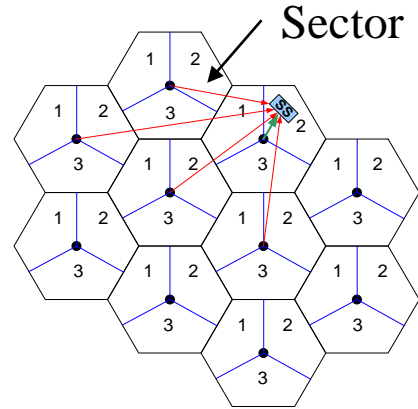

1x1x1

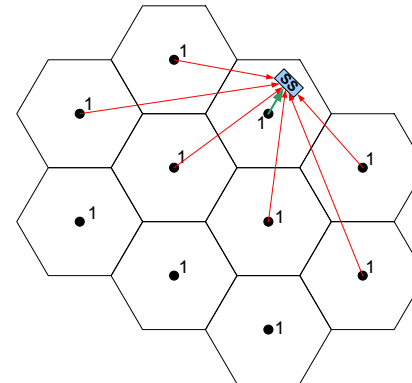

3x1x1

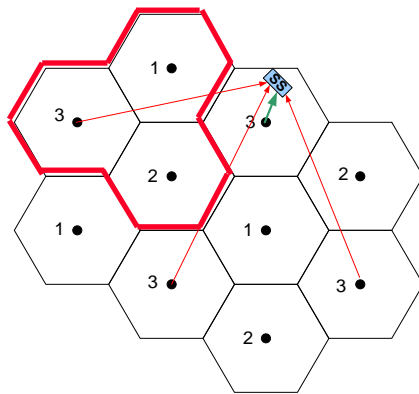

3x3x1

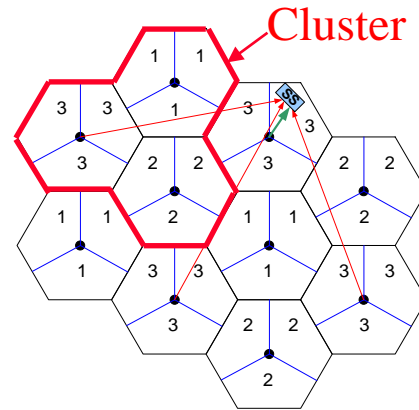

3x3x3

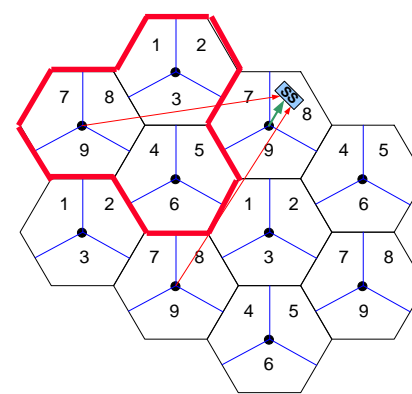

Student Questions

- ❑ What is the meaning of having >1 sector but 1 frequency across all sectors?

The directional antennae divide the cell into different sectors.

- ❑ When a user is at the cell boundary (for example, 1x3x3), could it use both frequencies simultaneously to improve the upload rate?

Yes, if it has two transmit circuits and antennae, like two nodes in one box.

- ❖ Which configuration is better in terms of bandwidth efficiency and system capacity?

More reuse ⇒ More bits/Hz and More cost

Fractional Frequency Reuse

- ❑ Users close to the BS use all frequency subchannels
- ❑ Users at the cell boundary use only a fraction of available subchannels

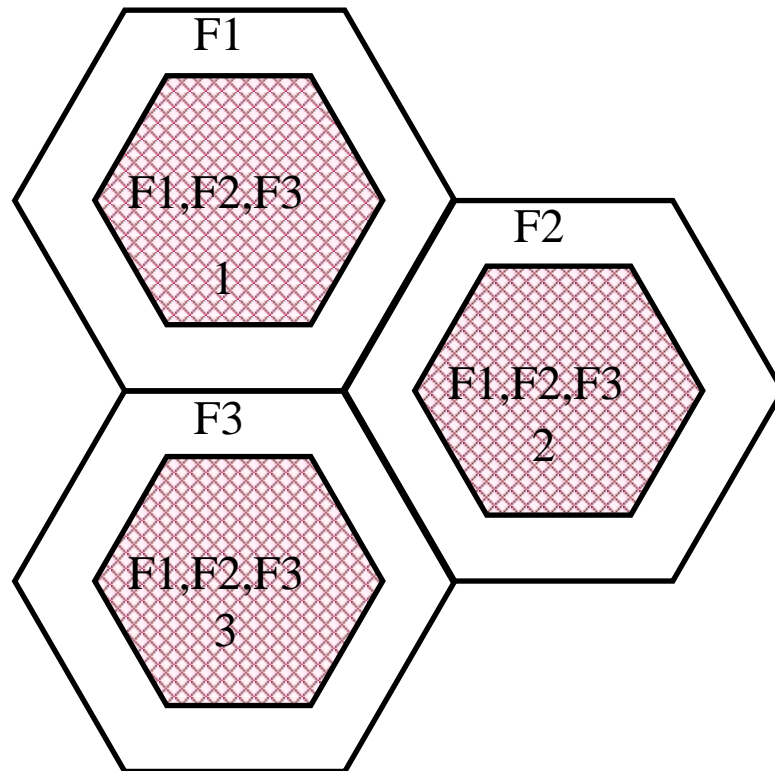

Student Questions

- ❑ Can you go over this slide again? I don't understand how boundary cells do not interfere with adjacent cells.

Tower 1 adjusts its transmission so that only F1 is high in its boundary cell. Tower 2 uses F2 for its boundary. Therefore they do not interfere even though they both use F1, F2, F3 in their core cells.

- ❑ Why are the cells hexagonal? Is this an approximation for an omnidirectional signal?

Yes.

- ❑ Can the cell boundary use more than 1 frequency, e.g., F1 and F2?

Only if you have enough frequencies not to cause a clash at the boundary. Not possible in the 3-cell cluster with 3 frequencies.

Homework 16B

- Label the frequency reuse patterns below.

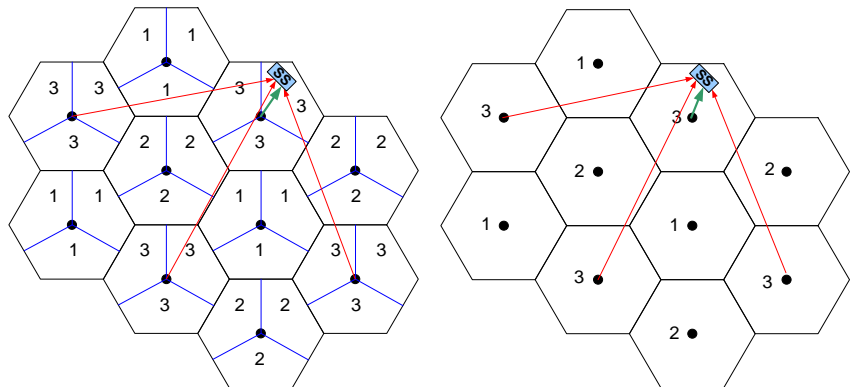
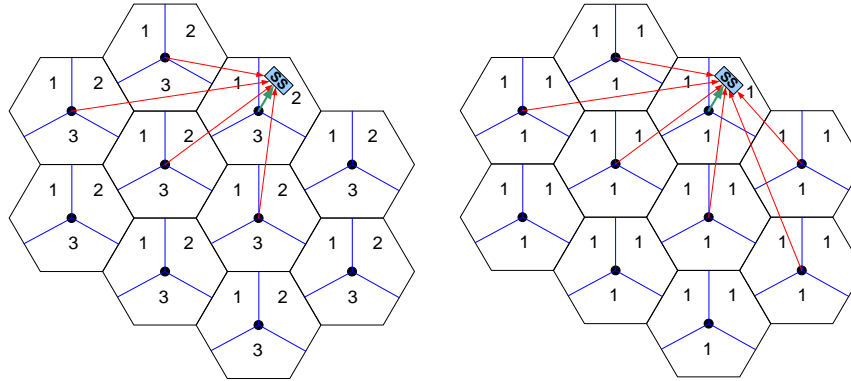

Student Questions

Cellular Telephony Generations

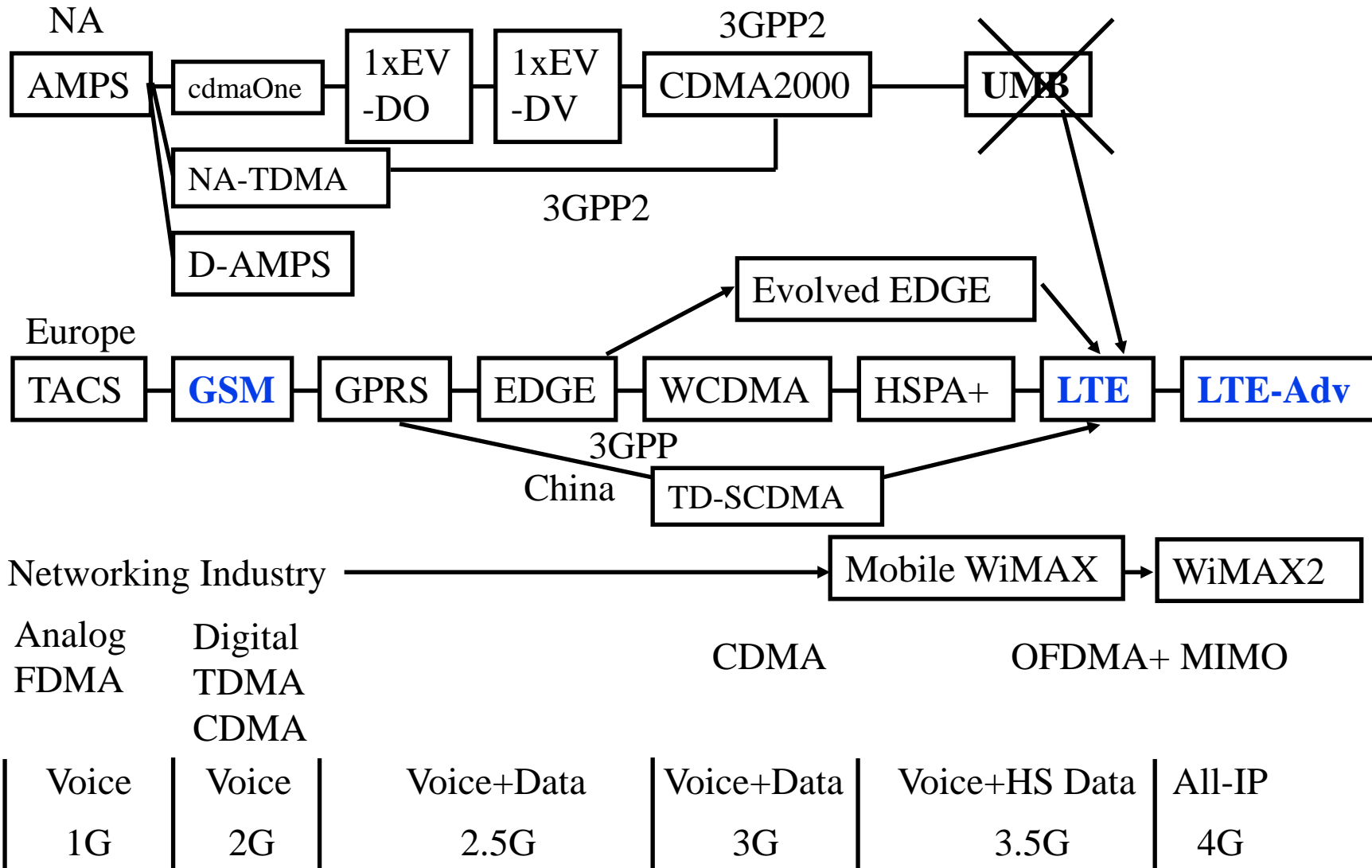

Student Questions

- ❑ Why is there X mark on UMB?
It was abandoned after some development. North America decided to go with the rest of the world.
- ❑ So, NA phones in the 1990s did not use GSM/GPRS/etc. But is that what they use now?
Yes. AT&T and T-Mobile use GSM. Verizon does not.
- ❖ Are mobile phones backward compatible?
To a certain extent. Most phones today will not work on 1G. Some will not work on 2G/GSM. Some will not work on different versions of 3G.

Cellular Generations (Cont)

❑ 1G: Analog Voice. FDMA. 1980s

- AMPS: Advanced Mobile Phone System
- TACS: Total Access Communications System

❑ 2G: Digital Voice. TDMA. 1990

- cdmaOne: Qualcomm. International Standard IS-95.
- NA-TDMA
- Digital AMPS (D-AMPS)
- **GSM**: Global System for Mobile Communications

❑ 2.5G: Voice + Data. 1995.

- 1xEV-DO: Evolution-Data Optimized
- 1xEV-DV: Evolution Data and Voice
- General Packet Radio Service (GPRS)
- Enhanced Data Rate for GSM Evolution (EDGE)

Student Questions

- ❑ Why did we evolve from analog->digital instead of starting with digital? Was analog significantly easier to implement?

Yes. Analog is an old technology. Initially, the music records were analog. All sound was analog. Now everything is digital.

Cellular Generations (Cont)

□ 3G: Voice + High-speed data. All CDMA. 2000.

- CDMA2000: Qualcomm. International Standard IS-2000.
- W-CDMA: Wideband CDMA
- TD-SCDMA: Time Division Synchronous Code Division Multiple Access (Chinese 3G)
- 384 kbps to 2 Mbps

□ 3.5G: Voice + Higher-speed data

- EDGE Evolution
- High-Speed Packet Access (HSPA)
- Evolved HSPA (HSPA+)
- Ultra Mobile Broadband (UMB)

Student Questions

Cellular Generations (Cont)

- ❑ Two Tracks for 1G/2G/3G:
 - Europe 3GPP (3rd Generation Partnership Project)
 - North America 3GPP2
- ❑ **3.9G: High-Speed Data. VOIP. OFDMA.**
 - WiMAX 16e (Worldwide Interoperability for Microwave Access)
 - Long Term Evolution (LTE)
- ❑ **4G: Very High-Speed Data. 2013.**
 - WiMAX 16m or WiMAX2
 - LTE-Advanced
 - 100 Mbps – 1 Gbps
- ❑ **5G: Ultra High-Speed Data. 2020.**
 - IP based

Student Questions

3.9G vs. 4G

- ❑ 3G = International Mobile Communications 2000 (IMT-2000)
= W-CDMA, CDMA2000
- ❑ 4G = IMT-Advanced
= LTE-Advanced, IEEE 802.16m
- ❑ WiMAX forum officially declared WiMAX to be 3G technology so they can use spectrum allocated to 3G.
- ❑ WiMAX and LTE are at most 3.9G or “near-4G.”
Some telecom companies are selling them as 4G

Student Questions

GSM

- ❑ Global System for Mobile Communications
- ❑ Implemented in 90% of cell phones worldwide.
- ❑ 1990 Technology using Time-Division Multiple Access (**TDMA**) instead of Frequency Division Multiple Access (FDMA) used in 1G
- ❑ 850/900/1800/1900 MHz (quad-band)
- ❑ **Subscriber Identity Module (SIM)** card contained user data. Users could use any phone with their SIM card

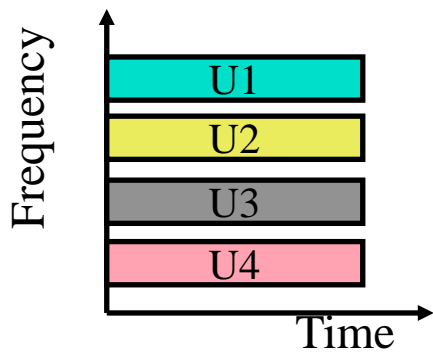

(a) FDMA

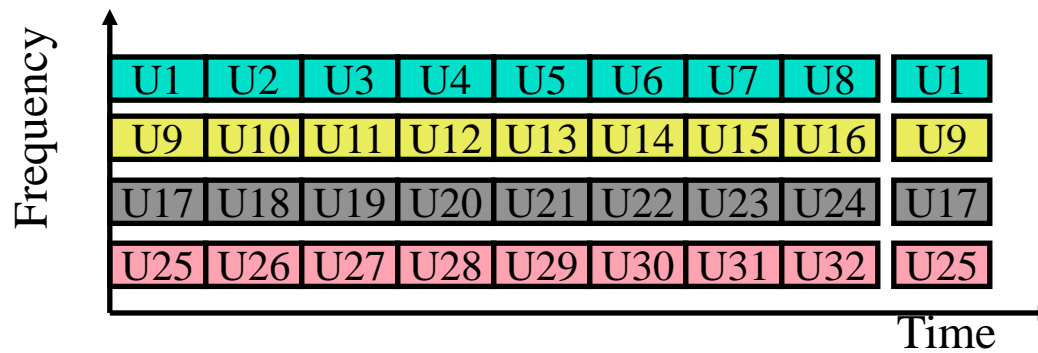

(B) TDMA

Student Questions

- ❑ It seems that some companies are stopping providing 3G services. Is GSM based on 2G still alive?

Yes.

GSM Cellular Architecture

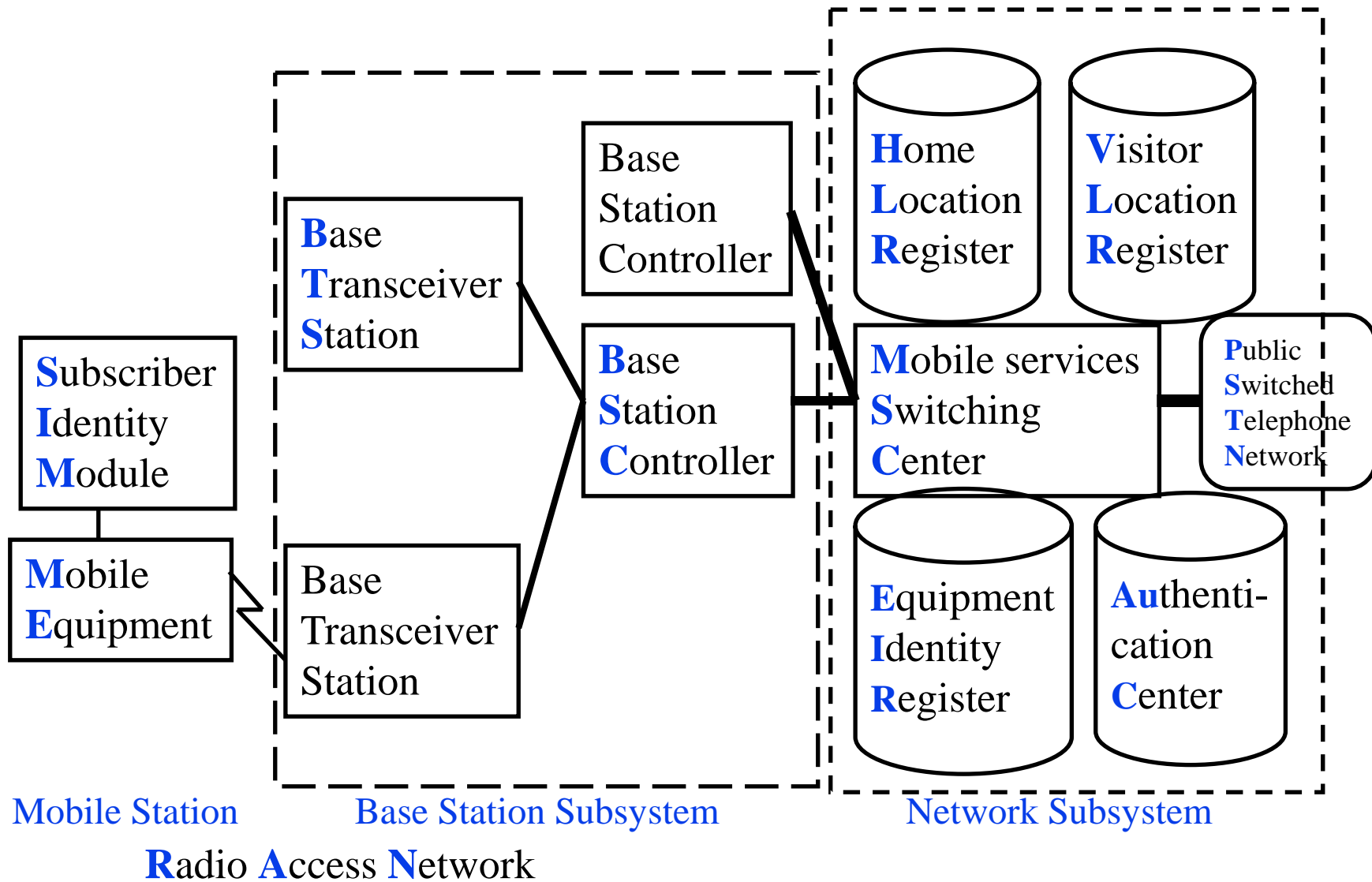

Student Questions

- ❑ What exactly is RAN again? Is it Mobile Station + Base Station Subsystem?

The left dashed rectangle is RAN. Basically there are two parts: one in the central office and the other (towers) in the field. Some of the electronics is on the top of the tower, the rest is in a hut/box at the bottom of the tower.

- ❖ Where is the most important component of the network? - The billing block?

Operations are generally in one centralized location. Not shown here.

Cellular Architecture (Cont)

- ❑ One Base transceiver station (BTS) per cell.
- ❑ One Base Station Controller (BSC) can control multiple BTS.
 - Allocates radio channels among BTSs.
 - Manages call handoffs between BTSs.
 - Controls handset power levels
- ❑ Mobile Switching Center (MSC) connects to PSTN and switches calls between BSCs. Provides mobile registration, location, and authentication. Contains Equipment Identity Register.

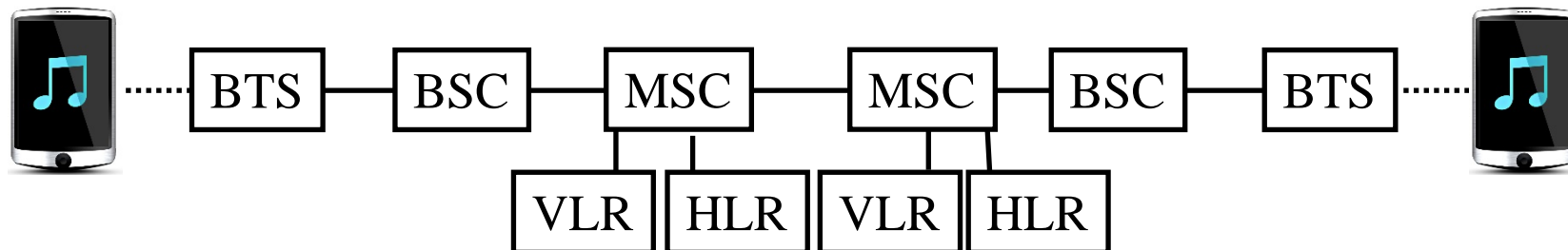

Student Questions

Cellular Architecture (Cont)

- ❑ **Home Location Register (HLR)** and Visitor Location Register (VLR) provide the call routing and roaming
- ❑ VLR+HLR+MSC functions are generally in one equipment
- ❑ Equipment Identity Register (EIR) contains a list of all valid mobiles.
- ❑ Authentication Center (AuC) stores the secret keys of all SIM cards.
- ❑ Each handset has an International Mobile Equipment Identity (IMEI) number.

Student Questions

- ❑ What is the difference between VLR and HLR? Why have both?

V=Visitors

H=Home

Everyone treats visitors differently than locals.

- ❖ Shouldn't EIR and AuC be part of BTS (at the point of entry)?

EIR and AuC are kept in the central office, which is weather-protected and secure.

GSM Radio Link

Slow Associated
Control
Channel (SACCH)

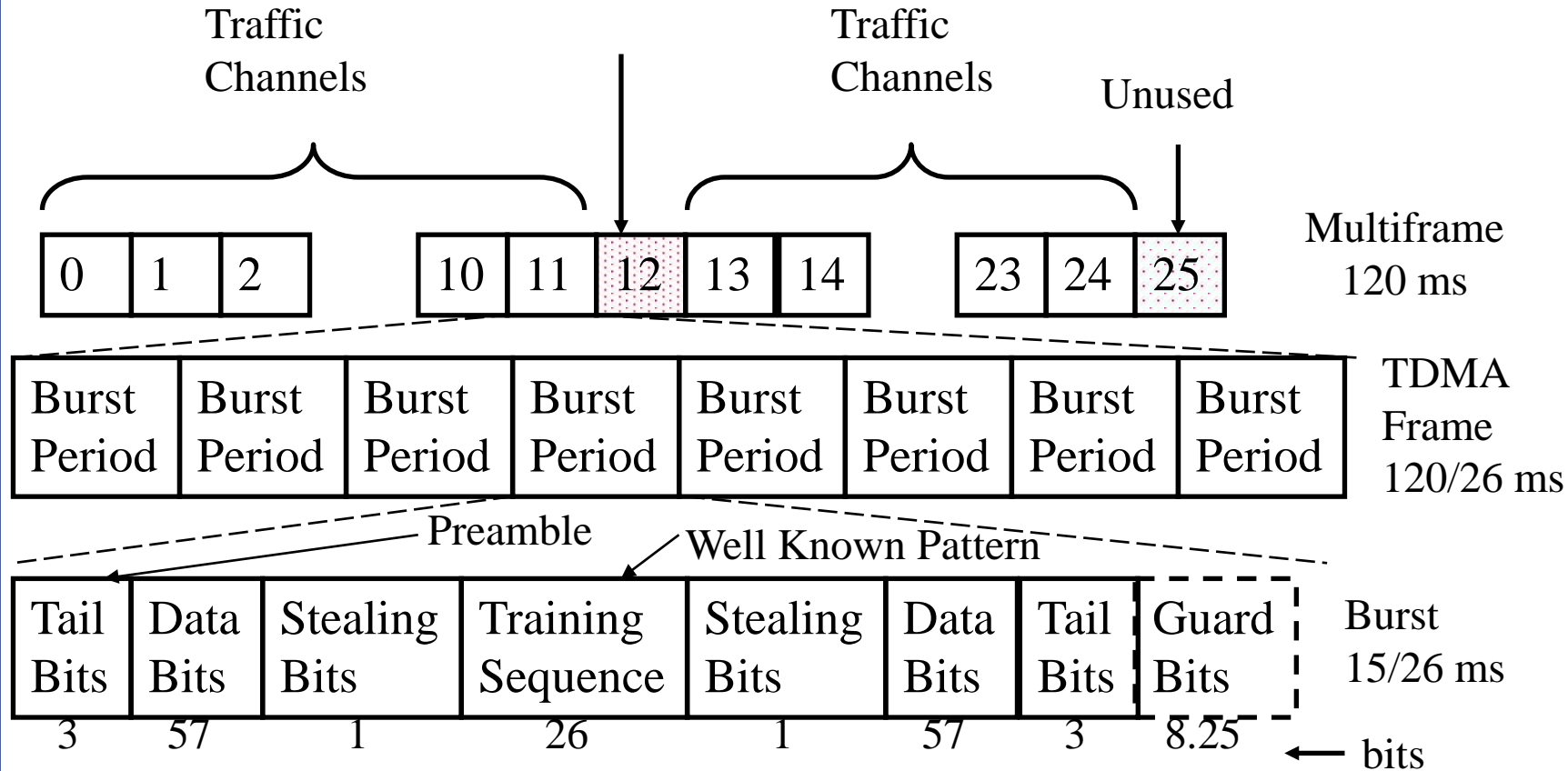

Student Questions

- Does FACCH steal the stealing bit, or some of the burst periods?

Just the bit.

- Why are the 2 stealing bits separate by the Training Sequence and not just a two bit section?

Each stealing bit causes a bit of distortion in sound and so distributing them lessens the effect.

- Does one "Multiframe" correspond to one frequency channel?

Yes. This is TDMA.

- Are the 26 slots in the time domain? In the slide they are also labeled as channels.

Yes, this is TDMA.

- Is "120/26 ms" 26 slots in 120 ms? *Yes.*
- Why are there two Tail-Data-Stealing Bits separated by "Training Sequence"?

The training sequence is like "pilots." It is used to determine the quality.

- Still unsure about the name stealing bits. Are they stolen from the user? Doesn't the user only send data bits?

Control bits are supposed to be in control channels. The stealing bits indicate whether control bits use the data channels in that burst. Causes mix-up of data plane and control plane.

Ref: Martin Sauter, "From GSM to LTE-Advanced: An Introduction to Mobile Networks and Mobile Broadband, Revised Second Edition," John Wiley & Sons, August 2014, 456 pp., ISBN:978-1-118-86195-0 (Safari Book).

GSM Radio Link (Cont)

- ❑ 890-915 MHz uplink, 935-960 MHz downlink
- ❑ 25 MHz \Rightarrow $125 \times 200\text{kHz}$ frequency channels
- ❑ Each frequency channel is TDMA with a burst (slot) period of 15/26 ms.
- ❑ Eight burst periods = TDMA frame of 120/26 ms.
- ❑ One user channel = one burst period per TDMA frame.
- ❑ 26 TDMA frames \Rightarrow one multiframe
24 are used for traffic, 1 for control and 1 is unused.
Slow Associated Control Channel (SACCH)
If SACCH does not have sufficient capacity, Fast Associated Control Channel (FACCH) is used by stealing $\frac{1}{2}$ of some bursts.
- ❑ **Stealing bits** identify whether the 1/2-slot carries data or control
- ❑ 200 kHz = 270.8 kbps over 26 slots
 \Rightarrow 9.6 kbps/user after encryption and FEC overhead

Student Questions

- ❑ I didn't fully understand the purpose of the stealing bits. Could you go over them again?

Control channels need bits. Some control channels with very low data rate need so few bits that they decided to share some bits for both user and control. This was done at a time when links were low speed (and bits were expensive). This kind of complexity is avoided in newer higher speed datalinks.

- ❑ Why do "Traffic Channels" here mean one burst period but indicate one TDMA frame in the previous slide?

One traffic channel = one-time slot = One TDMA frame = 8 burst periods = 8 user channels

❖ How did we get 270.8 kbps?
By multiplying by the b/Hz and taking care of the overhead. The details are not available. However, divided by 26, it produces 9.6 kbps for the users.

GSM Specs

- ❑ Full rate vocoders \Rightarrow Voice is sampled at 64 kbps compressed to 16 kbps.
- ❑ Subscriber Identify Module (SIM) contains a microcontroller and storage. It contains authentication, encryption, and accounting info.
Owners need a 4-digit PIN.
- ❑ SIM cards can contain additional info, such as emergency medical info.
- ❑ Mobile Assisted Handoff: Mobile sends identities of six candidate base stations for handoff. MSC selects.
- ❑ Short Message Service (SMS)
 - Up to 160 characters
 - Sent over a control channel
 - Unicast or broadcast

Student Questions

Cellular System Capacity Example

- A particular cellular system has the following characteristics: cluster size = 7, uniform cell size, user density = 100 users/sq km, allocated frequency spectrum = 900-949 MHz, bit rate required per user = 10 kbps uplink and 10 kbps downlink, and modulation code rate = 1 bps/Hz.

A. Using FDMA/FDD:

1. How much bandwidth is available per cell using FDD?
2. How many users per cell can be supported using FDMA?
3. What is the cell area?
4. What is the cell radius assuming circular cells?

B. If the available spectrum is divided into 35 channels and TDMA is employed within each channel:

1. What is the bandwidth and data rate per channel?
2. How many time slots are needed in a TDMA frame to support the required number of users?
3. If the TDMA frame is 10ms, how long is each user slot in the frame?
4. How many bits are transmitted in each time slot?

Student Questions

Cellular System Capacity (Cont)

- ❑ A particular cellular system has the following characteristics: cluster size =7, uniform cell size, user density=100 users/sq km, allocated frequency spectrum = 900-949 MHz, bit rate required per user = 10 kbps uplink and 10 kbps downlink, and modulation code rate = 1 bps/Hz.
- ❑ A. Using FDMA/FDD:
 1. How much bandwidth is available per cell using FDD?
 $49 \text{ MHz}/7 = 7 \text{ MHz/cell}$
FDD \Rightarrow 3.5 MHz/uplink or downlink
 2. How many users per cell can be supported using FDMA?
 $10 \text{ kbps/user} = 10 \text{ kHz} \Rightarrow 350 \text{ users per cell}$
 3. What is the cell area?
 $100 \text{ users/sq km} \Rightarrow 3.5 \text{ Sq km/cell}$
 4. What is the cell radius assuming circular cells?
 $\pi r^2 = 3.5 \Rightarrow r = 1.056 \text{ km}$

Student Questions

Cellular System Capacity (Cont)

B. If the available spectrum is divided into 35 channels and TDMA is employed within each channel:

1. What is the bandwidth and data rate per channel?

$$3.5 \text{ MHz}/35 = 100 \text{ kHz/Channel} = 100 \text{ kbps}$$

2. How many time slots are needed in a TDMA frame to support the required number of users?

$$10 \text{ kbps/user} \Rightarrow 10 \text{ users/channel}$$

3. If the TDMA frame is 10ms, how long is each user slot in the frame?

$$10 \text{ ms}/10 = 1 \text{ ms}$$

4. How many bits are transmitted in each time slot?

$$1 \text{ ms} \times 100 \text{ kbps} = 100 \text{ b/slot}$$

Student Questions

- B.2 seems to ask how many users can be supported in a TDMA frame instead of how many time slots.

Although GSM is TDMA, this example is about TDMA in general. Not GSM. Here each 100 kbps channel can support ten 10-kbps users. Each user is given a slot in the channel. That would be one user per "Traffic Channel" or TDMA frame in GSM terminology.

Homework 16C

- ❑ A particular cellular system has the following characteristics:
Cluster size = 9, uniform cell size, user density = 100 users/sq km, allocated frequency spectrum = 900-945 MHz, bit rate required per user = 10 kbps uplink and 10 kbps downlink, and modulation code rate = 2 bps/Hz.
- ❑ A. Using FDMA/FDD:
 - 1. How much bandwidth is available per cell using FDD?
 - 2. How many users per cell can be supported using FDMA?
 - 3. What is the cell area
 - 4. What is the cell radius assuming circular cells?
- B. If the available spectrum is divided into 100 channels and TDMA is employed within each channel:
 - 1. What is the bandwidth and data rate per channel?
 - 2. How many time slots are needed in a TDMA frame to support the required number of users?
 - 3. If the TDMA frame is 10ms, how long is each user slot in the frame?
 - 4. How many bits are transmitted in each time slot?

Student Questions

- ❖ Can you explain Question B.1?
 $\text{Bandwidth/channel} = \text{Total bandwidth from A.1} / \# \text{ of channels}$
 $\text{Data rate} = \text{bandwidth/channel} * (\text{b/Hz})$
-

GPRS

- ❑ General Packet Radio Service (GPRS). 2.5G Technology
- ❑ Standard GSM has 8 slots per **TDMA frame**
One slot/user \Rightarrow 9.6 kbps data/user
- ❑ GPRS allows any number of slots to a user
 - 4 different codings used depending upon channel condition
 - 9.6 kbps to 21.4 kbps per slot
 - 76-171 kbps using all 8 slots.
- ❑ GPRS users can hop frequency channels

G_i = GSM User

G_{pi} = GPRS User

	t_0	t_1	t_2	t_3	t_4	t_5	t_6	t_7	t_0	t_1	t_2
Uplink 1	G1		G2		GP2			GP1	G1		G2
Uplink 2				GP1			GP2				
Downlink 1	G1	GP1	G2		GP2			GP1	G1		G2
Downlink 2	GP1				GP1					GP2	

Student Questions

- ❑ Why is it not 26 slots per 200 kHz channel?
Corrected.

GPRS (Cont)

- ❑ Supports intermittent and bursty data transfers
Point-to-multipoint also supported
- ❑ Need to add two new elements to GSM networks:
 - **Service** GPRS support node (SGSN)
 - Security, Mobility, and Access control for data packet
 - **Gateway** GPRS support node (GGSN)
 - Connects to external packet-switched networks
- ❑ Standardized by ETSI

Student Questions

GSM/GPRS Network Architecture

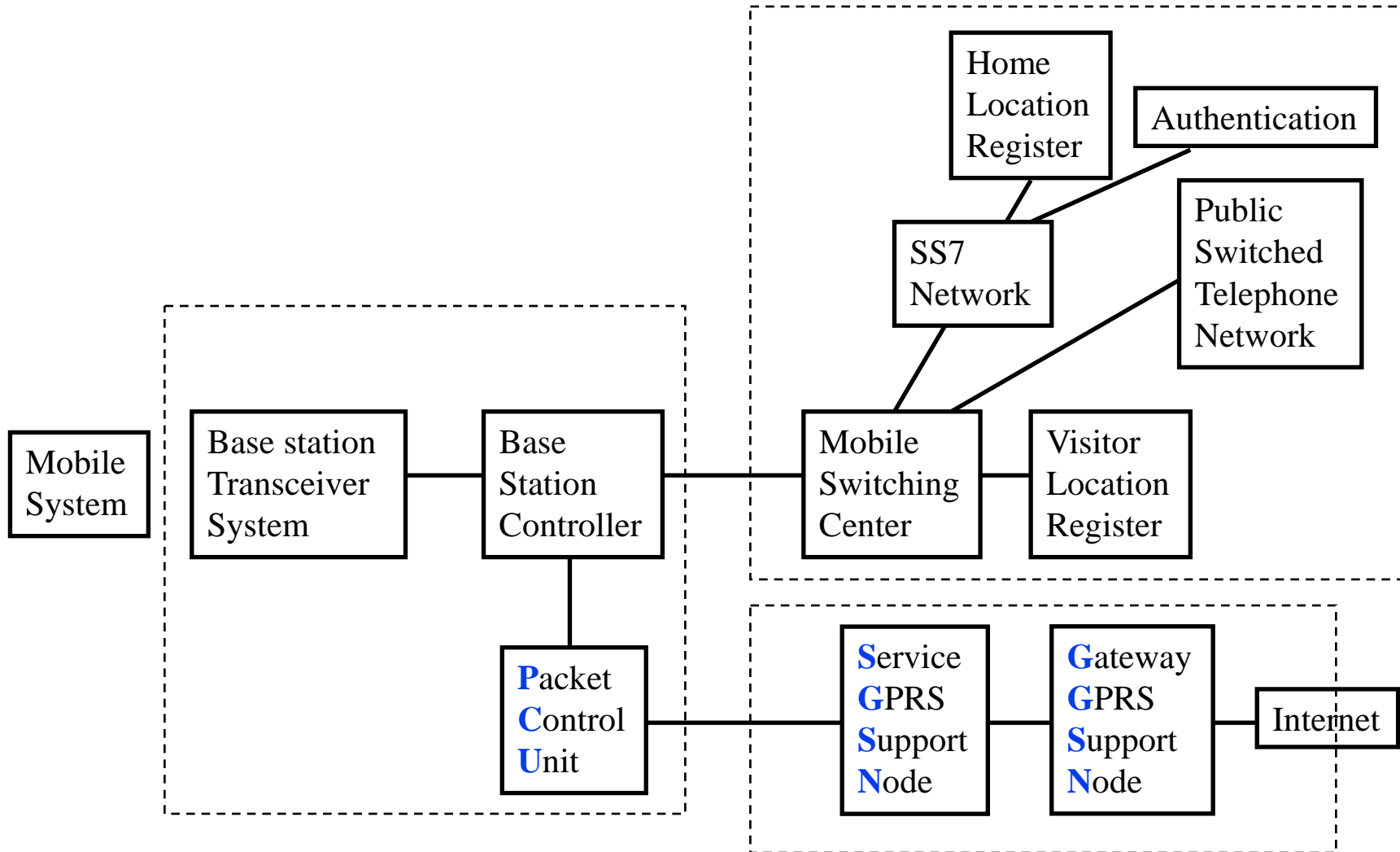

Student Questions

Ref: A. Ghosh, J. Zhang, J. G. Andrews, R. Muhamed, "Fundamentals of LTE," Prentice Hall, 2010, ISBN: 0137033117 464 pp. Safari book.

EDGE

- ❑ Enhanced Data Rates for GSM Evolution (EDGE)
- ❑ Standard GSM uses Gaussian Minimum Shift Keying (GMSK) modulation.
 - Data stream is shaped with a Gaussian filter before frequency modulation
- ❑ EDGE changes to 8-PSK modulation \Rightarrow 3 bps/Hz
- ❑ GPRS+EDGE \Rightarrow 384 kbps
- ❑ Need better radio signal quality
- ❑ GSM-EDGE Radio Access Network (GERAN)

Student Questions

- ❑ What is the purpose of applying Gaussian filter?
Makes the signal smoother. Reduces the harmonics.

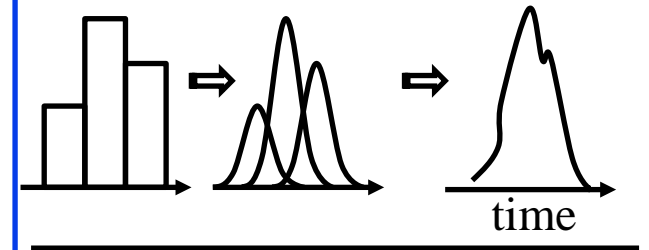

W-CDMA

- ❑ Wideband Code Division Multiple Access
- ❑ European 3G
- ❑ Aka Universal Mobile Telecommunications System (UMTS)
- ❑ Uses Direct Sequence Spread Spectrum over two 5 MHz FDD channels
- ❑ Radio access network is called “UMTS Terrestrial Radio Access Network (UTRAN).”
- ❑ Air interface is called “UMTS Terrestrial Radio Access (UTRA).”

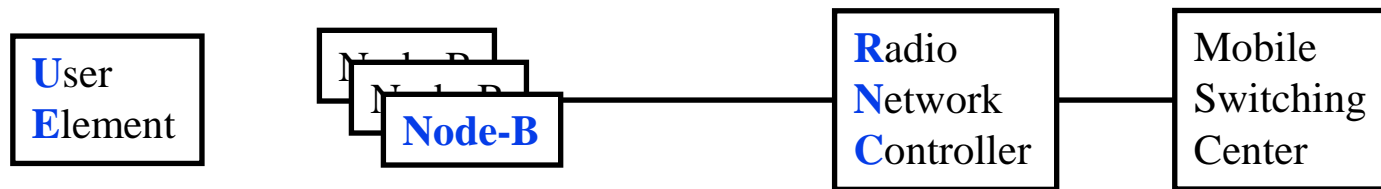

Student Questions

- ❑ What is Air interface?
Mobile-tower communication
= wireless communication
= Radio part of the system
as opposed to the central system
-

High-Speed Packet Access (HSPA)

- ❑ Evolution (extension) of W-CDMA
- ❑ High-Speed Downlink **Packet** Access (HSDPA):
 - Adaptive modulation and coding
 - Channel-dependent scheduling
 - Higher order modulations, e.g., 16-QAM
- ❑ High-Speed Uplink Packet Access (HSUPA):
 - Parallel transmissions from multiple users
- ❑ HSPA = HSDPA+HSUPA
 - Up to 64-QAM
- ❑ HSPA+: Evolution of HSPA. Up to 168 Mbps down, 22 Mbps up using MIMO and multiple carriers

Student Questions

Evolved Packet System (EPS)

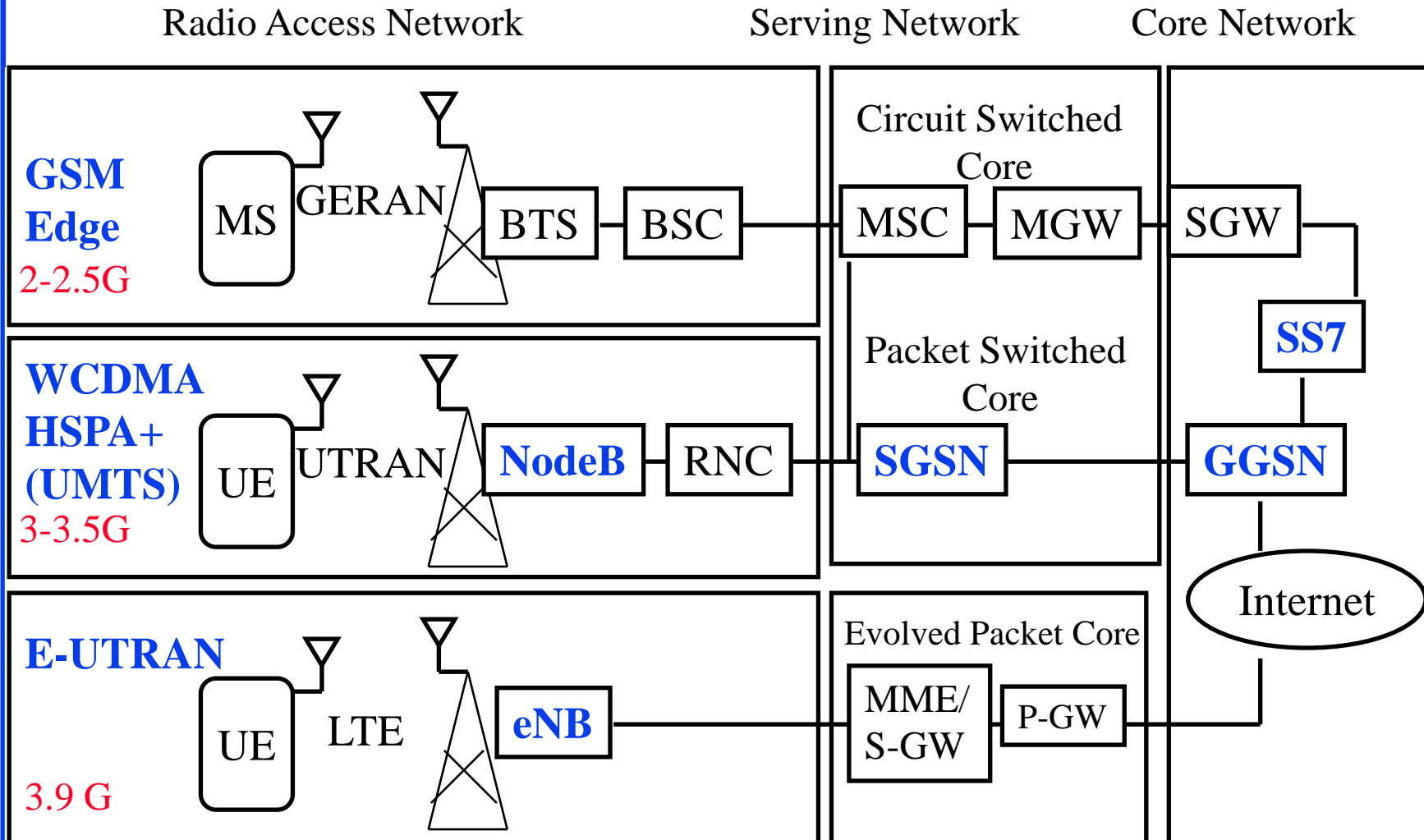

Student Questions

Evolved Packet System (Cont)

- ❑ CS = Circuit Switched
- ❑ EPC = Evolved Packet Core
- ❑ EPS = Evolved Packet System
- ❑ GERAN = GSM Enhanced Radio Access Network
- ❑ GGSN = Gateway GPRS Support Node
- ❑ LTE = Long Term Evolution
- ❑ MGW = Media Gateway
- ❑ MME = Mobility Management Utility
- ❑ MSC = Mobile Switching Center
- ❑ P-GW = Packet Gateway
- ❑ PS = Packet Switched
- ❑ RNC = Radio Network Control
- ❑ S-GW = Serving Gateway
- ❑ SGSN = Service GPRS Support Node
- ❑ SS7 = Signaling System 7
- ❑ eNB = Evolved NodeB

Student Questions

Summary

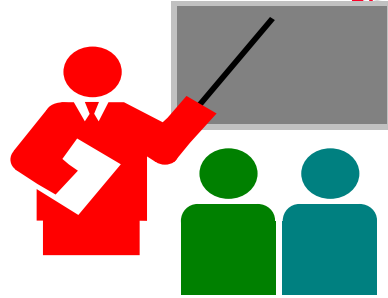

1. In a cellular cluster of size N , the same distance between cells with the same frequencies is $D = R \sqrt{3N}$. Here R is the cell radius.
2. 1G was an analog voice system with FDMA
3. 2G was a digital voice system with TDMA. Most widely implemented 2G is GSM. Data rate was improved by GPRS and EDGE.
4. 3G was voice+data system with CDMA. Most widely implemented 3G is W-CDMA using two 5 MHz FDD channels.
5. Data rate was improved later using HSPA and HSPA+.

Student Questions

Reading List

- ❑ Martin Sauter, "From GSM to LTE-Advanced: An Introduction to Mobile Networks and Mobile Broadband, Revised Second Edition," John Wiley & Sons, August 2014, 456 pp., ISBN:978-1-118-86195-0 (Safari Book).
- ❑ C. Siva Ram Murthy; B. S. Manoj, "Ad Hoc Wireless Networks Architectures and Protocols," Prentice Hall, 2004, ISBN: 013147023X, 880 pp., Safari Book.

Student Questions

Wikipedia Links

- ❑ http://en.wikipedia.org/wiki/Advanced_Mobile_Phone_System
- ❑ <http://en.wikipedia.org/wiki/CDMA>
- ❑ <http://en.wikipedia.org/wiki/IS-2000>
- ❑ <http://en.wikipedia.org/wiki/IS-95>
- ❑ <http://en.wikipedia.org/wiki/W-CDMA>
- ❑ http://en.wikipedia.org/wiki/Evolution-Data_Optimized
- ❑ http://en.wikipedia.org/wiki/EV-DV#Potential_competing_standards
- ❑ <http://en.wikipedia.org/wiki/GSM>
- ❑ <http://en.wikipedia.org/wiki/GPRS>
- ❑ <http://en.wikipedia.org/wiki/EDGE>
- ❑ http://en.wikipedia.org/wiki/Evolved_EDGE
- ❑ <http://en.wikipedia.org/wiki/TD-SCDMA>
- ❑ http://en.wikipedia.org/wiki/High_Speed_Packet_Access
- ❑ http://en.wikipedia.org/wiki/Ultra_Mobile_Broadband
- ❑ <http://en.wikipedia.org/wiki/IMT-2000>

Student Questions

References

- ❑ P. Bedell, “Cellular Networks: Design and Operation, A real World Perspective,” Outskirts Press, 2014, ISBN:9781478732082 (Good/easy reading but not a Safari book)
- ❑ 3G Americas, <http://www.3gamericas.org>
- ❑ 3G Americas, “The mobile broadband revolution: 3GPP Release 8 and beyond, HSPA+, SAE/LTE and LTE-Advanced,” White paper, February 2009.

Student Questions

Acronyms

- ❑ 3GPP 3rd Generation Partnership Project
- ❑ AMPS Advanced Mobile Phone System
- ❑ AuC Authentication Center
- ❑ BS Base Station
- ❑ BSC Base Station Controller
- ❑ BTS Base transceiver station
- ❑ CDMA Code Division Multiple Access
- ❑ CoW Cell on Wheels
- ❑ CS Circuit Switched
- ❑ DC District of Columbia
- ❑ DO Data-Only
- ❑ DV Data+Voice
- ❑ EDGE Enhanced Data rate for GSM evolution
- ❑ EIR Equipment Identity Register
- ❑ eNB eNodeB
- ❑ EPC Evolved Packet Core

Student Questions

Acronyms (Cont)

- ❑ EPS Evolved Packet System
- ❑ ETSI European Telecommunications Standards Institute
- ❑ EVDO Evolution to Data only
- ❑ EVDV Evolution to Data and voice
- ❑ FACCH Fast Associated Control Channel
- ❑ FDD Frequency Division Duplexing
- ❑ FDMA Frequency Division Multiple Access
- ❑ FEC Forward Error Correction
- ❑ GERAN GSM Enhanced Radio Access Network
- ❑ GGSN Gateway GPRS Support
- ❑ GMSK Gaussian Minimum Shift Keying
- ❑ GP GPRS user slot
- ❑ GPRS General Packet Radio Service
- ❑ GSM Global System for Mobile Communications
- ❑ GW Gateway
- ❑ HLR Home Location Register

Student Questions

Acronyms (Cont)

- ❑ HS High Speed
- ❑ HSDPA High-speed Downlink Packet Access
- ❑ HSPA High-speed Packet Access
- ❑ HSPA+ Evolved High-speed Packet Access
- ❑ HSUPA High-Speed Uplink Packet Access
- ❑ IEEE Institution of Electrical and Electronic Engineers
- ❑ IMEI International Mobile Equipment Identity
- ❑ IMT-2000 International Mobile Communications 2000
- ❑ IMT-Advanced International Mobile Communications Advanced
- ❑ IP Internet Protocol
- ❑ IS International Standard
- ❑ kHz Kilo Hertz
- ❑ LTE Long-Term Evolution
- ❑ MGW Media Gateway
- ❑ MHz Mega Hertz
- ❑ MIMO Multiple Input Multiple Output
- ❑ MME Mobility Management Utility

Student Questions

Acronyms (Cont)

- ❑ MS Mobile Station
- ❑ MSA Metropolitan Service Areas
- ❑ MSC Mobile Switching Center
- ❑ NA-TDMA North America Time Division Multiple Access
- ❑ NA North America
- ❑ NIMBY Not in my backyard
- ❑ NodeB Base Station
- ❑ OFDMA Orthogonal Frequency Division Multiple Access
- ❑ PIN Personal Identification Number
- ❑ PS Packet Switched
- ❑ PSK Phase Shift Keying
- ❑ PSTN Public Switched Telephone Network
- ❑ QAM Quadrature Amplitude Modulation
- ❑ RNC Radio Network Control
- ❑ SACCH Slow Associated Control Channel

Student Questions

Acronyms (Cont)

- ❑ SCDMA Synchronous CDMA
- ❑ SGSN Service GPRS Support Node
- ❑ SGW Service Gateway
- ❑ SIM Subscriber Identify Module
- ❑ SMS Short Message Service
- ❑ SS7 Signaling System 7
- ❑ TACS Total Access Communications System
- ❑ TD-SCDMA Time Duplexed Synchronous Code Division Multiple Access
- ❑ TDMA Time Division Multiple Access
- ❑ UE User Element
- ❑ UMB Ultra Mobile Broadband
- ❑ UMTS Universal Mobile Telecommunications System
- ❑ UTRA UMTS Terrestrial Radio Access
- ❑ UTRAN UMTS Terrestrial Radio Access Network
- ❑ VLR Visitor Location Register
- ❑ VOIP Voice over IP

Student Questions

Acronyms (Cont)

- ❑ WCDMA Wideband Code Division Multiple Access
- ❑ WiMAX Worldwide Interoperability for Microwave Access

Student Questions

Scan This to Download These Slides



Raj Jain

<http://rajjain.com>

Student Questions

http://www.cse.wustl.edu/~jain/cse574-24/j_16cel.htm

Related Modules



CSE567M: Computer Systems Analysis (Spring 2013),
https://www.youtube.com/playlist?list=PLjGG94etKypJEKjNAa1n_1X0bWWNyZcof

CSE473S: Introduction to Computer Networks (Fall 2011),
https://www.youtube.com/playlist?list=PLjGG94etKypJWOSPMh8Azcg5e_10TiDw



Recent Advances in Networking (Spring 2013),
<https://www.youtube.com/playlist?list=PLjGG94etKypLHyBN8mOgwJLHD2FFIMGq5>

CSE571S: Network Security (Fall 2011),
<https://www.youtube.com/playlist?list=PLjGG94etKypKvzfVtutHcPFJXumyyg93u>



Video Podcasts of Prof. Raj Jain's Lectures,
<https://www.youtube.com/channel/UCN4-5wzNP9-ruOzQMs-8NUw>

Student Questions